

HAWORTH

# Moxie

North America Price List – July 2026





**This Haworth North American price book contains US list prices.**

Canadian customers can convert the US list price into their Canadian equivalent by going to [www.Haworth.com/Canada](http://www.Haworth.com/Canada) to find the current Canadian multipliers. These multiplier factors allow you to convert the US list price into a Canadian list price.





**This Page Intentionally Left Blank**

# Moxie – Modular Lounge Price List

Includes pricing, catalog numbers, finish codes/availability, specification requirements, line art, dimensions, and specification tips for Moxie.

**Straight Lounge**

**Curved Lounge**

**Square Corner Lounge**

**Half-Round Lounge**

**Intermediate Arm**

**Intermediate Tablet**

**Screens**

**Tables**

**Power Module**

# Table of Contents

---

## Price List

**Statement of Line** ..... 7

**Moxie — At-A-Glance**

  General Specifications ..... 10

**Moxie — Modular Lounge**

  Seating — Catalog Logic ..... 11

  Screens — Catalog Logic ..... 12

  Tables — Catalog Logic ..... 13

  Seating ..... 14

  Straight Lounge ..... 15

  Curved Lounge ..... 26

  Square Corner Lounge ..... 31

  Half-Round Lounge ..... 34

  Intermediate Arm ..... 36

  Intermediate Tablet ..... 37

  Screens ..... 38

  Straight Screen ..... 38

  Straight Screen with Return ..... 39

  Curved Screen ..... 39

  Square Corner Screen ..... 40

  Screen Alignment Clip ..... 40

  Tables ..... 41

  Rectangle Table ..... 41

  Square Corner Table ..... 43

  Round Table ..... 44

  Power Module — Corded ..... 45

  Power Module — Hardwire ..... 45

## Resources

**Surface Materials** ..... 47

**COM Yardage Requirements** ..... 49

**Index** ..... 51

**Warranty**

  Lifetime Product Warranty ..... Inside Back Cover

# Statement of Line

## Straight Lounge

Pages 15-25

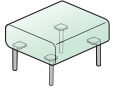

**No Back Starter**

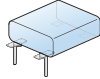

**No Back Adder**

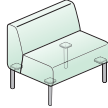

**Mid-Back Starter - No Arms**

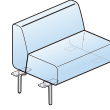

**Mid-Back Adder - No Arms**

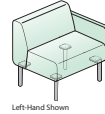

Left-Hand Shown

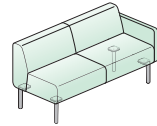

Left-Hand Shown

**Mid-Back Starter - One Arm**

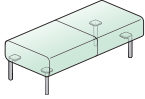

**Mid-Back Adder - Left-Hand Arm**

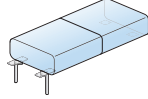

**Mid-Back Starter - Both Arms**

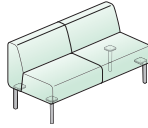

**High-Back Starter - No Arms**

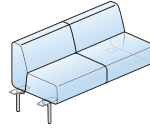

**High-Back Adder - No Arms**



Left-Hand Shown

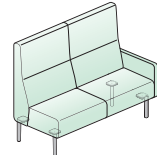

Left-Hand Shown

**High-Back Starter - One Arm**

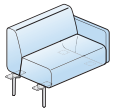

**High-Back Adder - Left-Hand Arm**

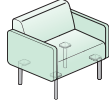

**High-Back Starter - Both Arms**

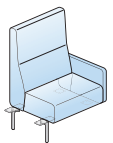

**High-Back Adder - Left-Hand Arm**



**High-Back Starter - Both Arms**

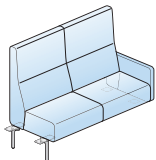

**High-Back Adder - Left-Hand Arm**

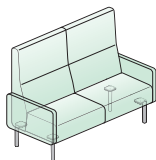

**High-Back Starter - Both Arms**

## Curved Lounge

Pages 9-12

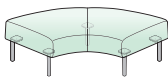

**90° Concave Starter - No Back**

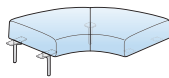

**90° Concave Adder - No Back**

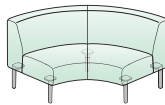

**90° Concave Starter - Mid-Back**

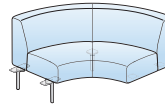

**90° Concave Adder - Mid-Back**

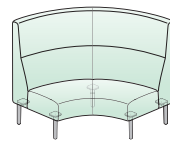

**90° Concave Starter - High-Back**

# Statement of Line

## Curved Lounge (cont'd)

Pages 9-12

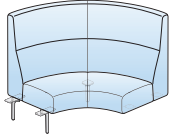

90° Concave Adder - High-Back

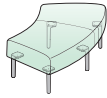

45° Convex Starter - No Back

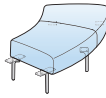

45° Convex Adder - No Back



45° Convex Starter - Mid-Back



45° Convex Adder - Mid-Back



45° Convex Starter - High-Back



45° Convex Adder - High-Back

## Square Corner Lounge

Pages 31-33



Starter - No Back



Adder - No Back



Starter - Mid Back



Adder - Mid Back

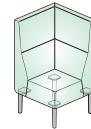

Starter - High Back

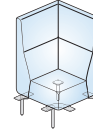

Adder - High Back

## Half-Round Lounge

Pages 34-36

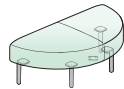

Starter - No Back

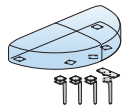

Adder - No Back

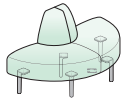

Starter - Mid-Back

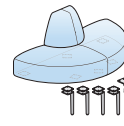

Adder Mid-Back

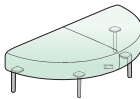

Starter - No Back

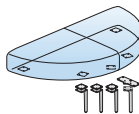

Adder - No Back

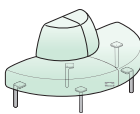

Starter - Mid-Back

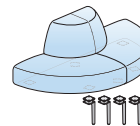

Adder Mid-Back

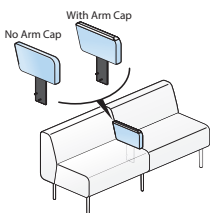

Intermediate Arm

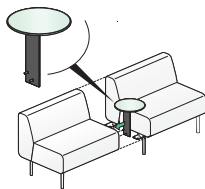

Intermediate Tablet

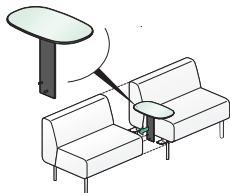

Intermediate Tablet

# Statement of Line

## Screens

Pages 39-40



Straight Screen



Straight Screen with Return



Curved Screen



Square Corner Screen

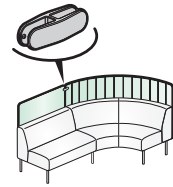

Screen Alignment Clip

## Tables

Pages 41-44



Rectangle Table - Starter



Rectangle Table - Adder

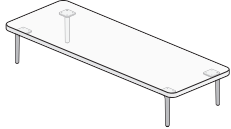

Rectangle Table - Starter

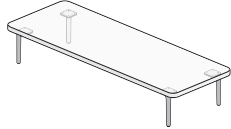

Rectangle Table - Adder



Square Corner Table - Starter



Square Corner Table - Adder



Round Table

## Power Module

Page 45

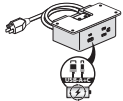

Corded

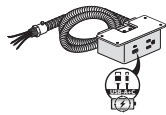

Hardwire

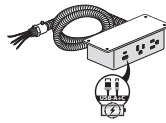
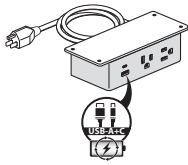

# Moxie — At-A-Glance

## General Specifications

---

<b>Designer</b>	Haworth Design Studio
<b>Moxie</b>	A modular lounge that turns ordinary spaces into destinations. It fits your people, your space, and your budget. Moxie effortlessly blends into any space, anchoring high-traffic spaces with durable construction and optional cleanable surfaces. Generous proportions and a working-lounge posture invite comfortable group collaboration. Combine with Moxie lounge chairs and tables to build unified layouts.
<b>Awards</b>	Nightingale Award - Silver
<b>Environmental Factors</b>	BIFMA X5.41-600
<b>Specifications</b>	Designed to support up to 600 lbs per seated position.

---

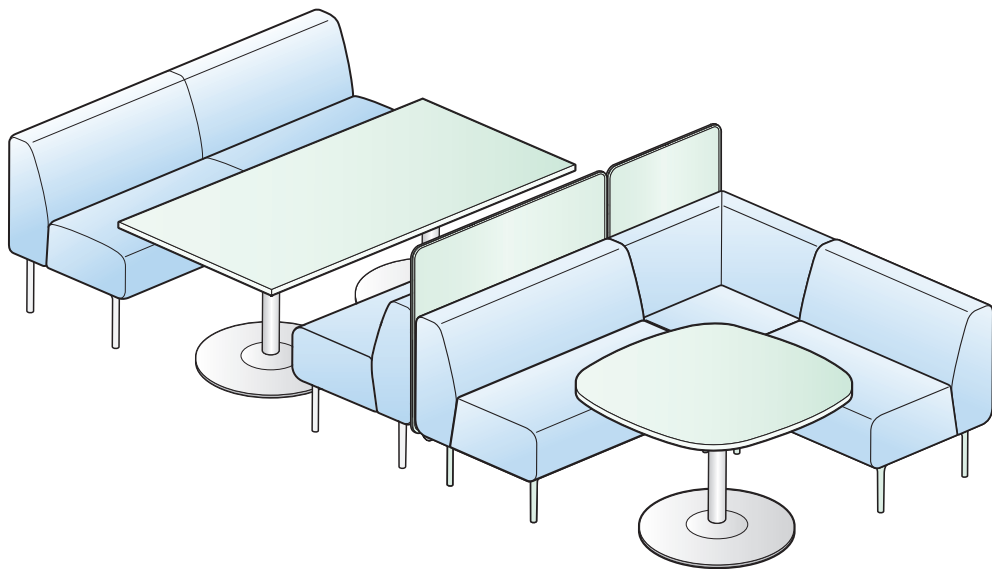
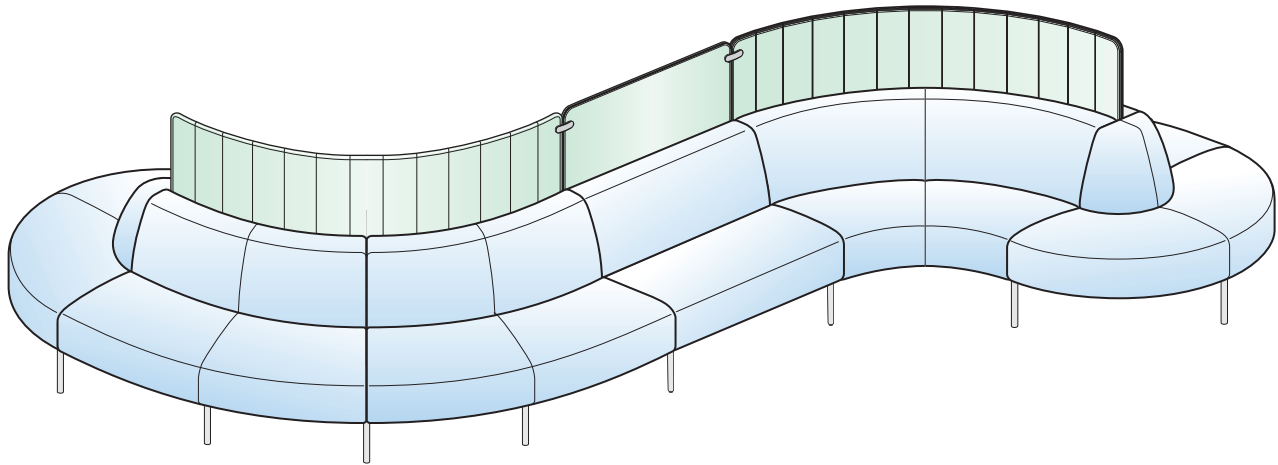

# Moxie — Modular Lounge

## Seating

### Catalog Logic

S X S N - 2 O O U - 24 M S N N H

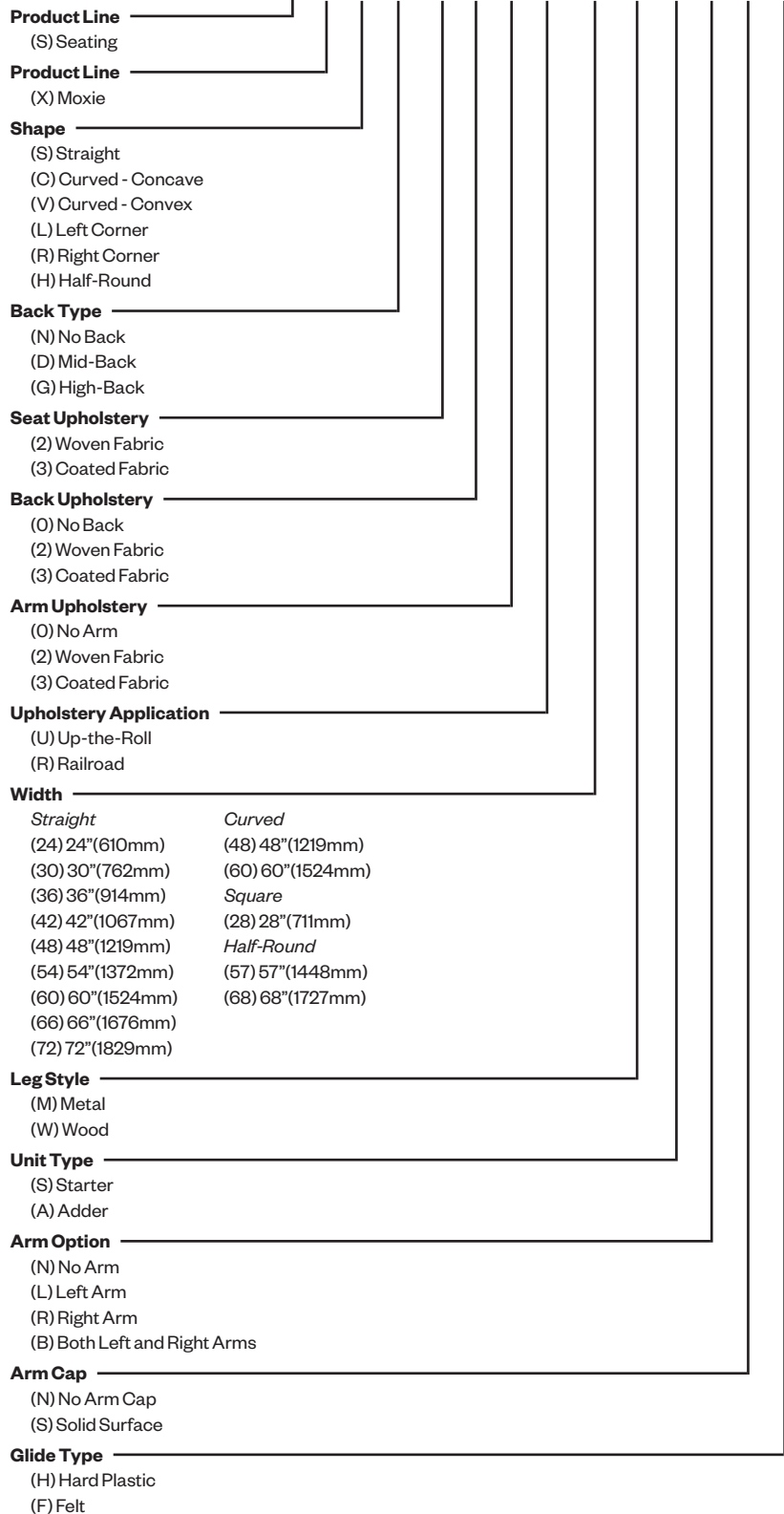

# Moxie — Modular Lounge

## Screens

### Catalog Logic

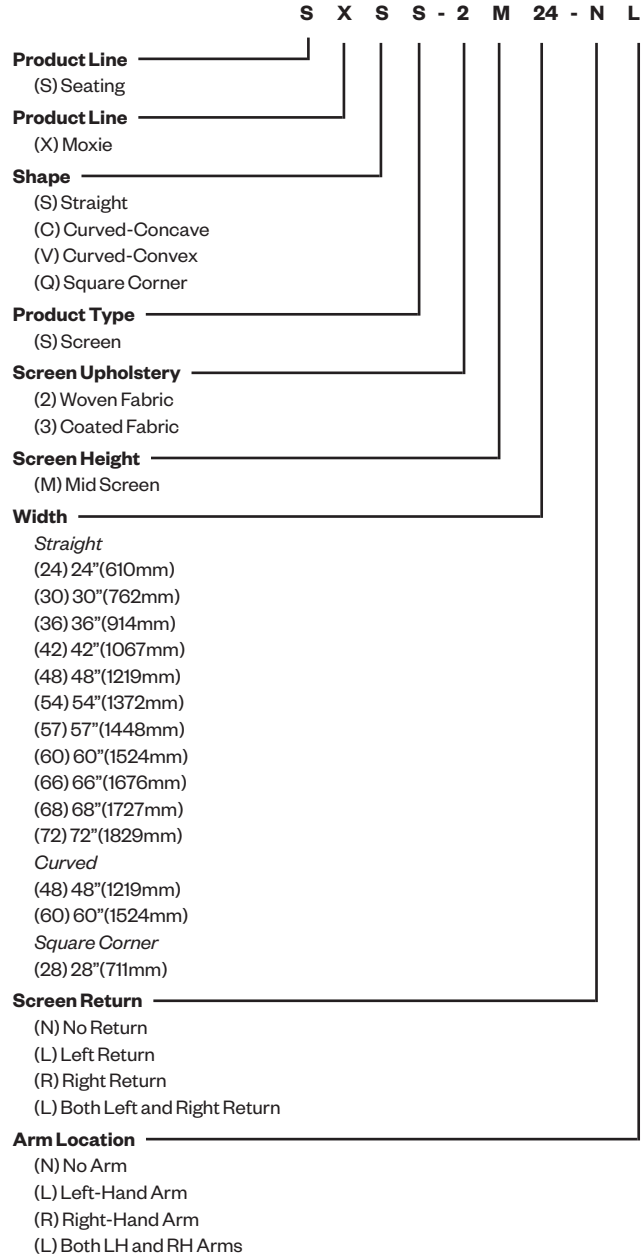

# Moxie — Modular Lounge Tables

## Catalog Logic

S X R T - 24 57 - L M S H

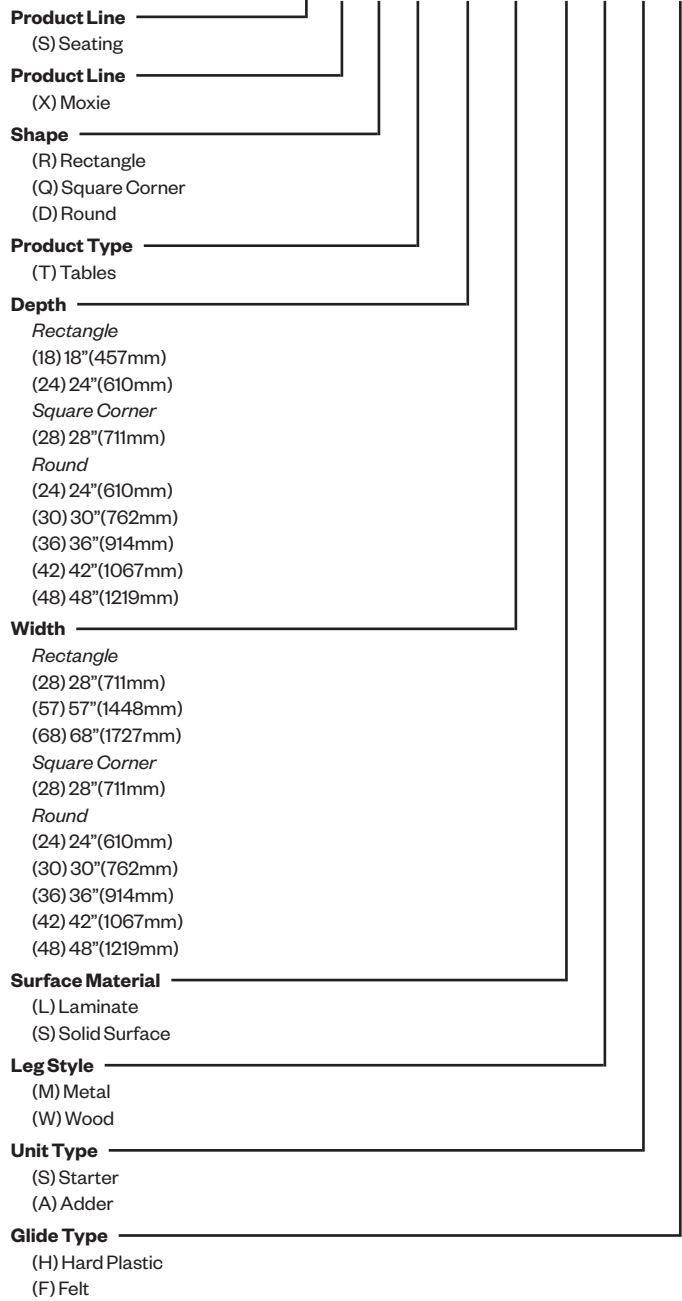

# Moxie — Modular Lounge

Haworth/Haworth Design Studio/2026/Made in the United States

---

## Seating

- Seating is available as a Straight, 90° Concave Curve, 45° Convex Curve, Square Corner and Half-Round units.
  - Starter kits include legs and spacer brackets and may be used as stand alone seating, or may be combined with Adder Kits to create a modular lounge application.
  - Adder kits include the appropriate number of legs and shared leg brackets. May not be used as a stand alone seat.
- Moxie Modular Lounge seating may be specified with Woven or Coated fabric. For a complete list of upholstery options please refer to [surfaces.haworth.com](http://surfaces.haworth.com)
- Upholstery Type - Seat, back and arm(s) each specified separately. These three surfaces may be same upholstery and color or may be complementary upholstery and colors.
- Upholstery application - available standard Up the Roll or railroaded. Modification of the product number is required.
- Back - No Back, Mid-back and High-Back available on Straight, Concave, Convex and Square Corner units. Half-Round unit available with No Back or Mid-Back only.
- Legs - 10"(254mm)H. Available in painted metal or wood. Appropriate brackets are included and standard in black. Legs and brackets are field installed.
- Glides - Have 0.5"(13mm) leveling adjustment and are available as hard plastic or felt.
- Arms - Available on straight units only with mid-back or high-back. Optional solid surface arm caps available.
- Power - Underseat power is available; separately specified.
- Screens - Available on Mid-Back units only; separately specified.
- Intermediate Arm available on mid-back and high-back seating to provide separation and arm rest between two seats. Will mount on the left-hand unit. Optional solid surface arm caps available.
- Intermediate Tablet mounts between two seating units. Tablet mounts to the left-hand unit. Units must be a mid-back or high-back. Available as oval or round in high-pressure laminate (HPL) or solid surface.
- Patterned material will not be pattern matched.

# Moxie — Modular Lounge

Haworth/Haworth Design Studio/2026/Made in the United States

## Straight Lounge

### Unique Features

- Arm Options:
  - Starter - No arm, right arm, left arm or both RH and LH arms.
  - Adder - No arm or left arm.
- Arm(s) available on mid-back and high-back units only.
- Arm handedness determined from seated position.
- Optional solid surface arm caps available. Modification of the product number is required.
- Seats 48"(1219mm)W and wider will have a center seam.
- Legs:
  - Starter - Four legs and four spacer brackets.
  - Adder - Two legs and two shared leg brackets.

### To Order, Specify:

1) Product number, including:

**1 Seat material:**

- 2** Woven Fabric
- 3** Coated Fabric

**2 Back Material (if applicable):**

- 2** Woven Fabric
- 3** Coated Fabric

**3 Arm Material (if applicable):**

- 2** Woven Fabric
- 3** Coated Fabric

**4 Leg Style:**

- M** Metal
- W** Wood (add **\$400.00** List)

**5 Glide Style:**

- H** Hard Plastic
- F** Felt

2) Seat material and color.

3) Back material and color (if applicable).

4) Arm material and color (if applicable).

5) Leg color/finish.

6) Arm cap color (if applicable).  
SS-CW White

## No Back Starter

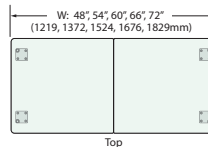
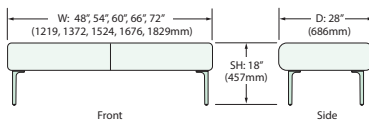
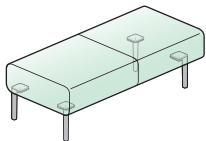
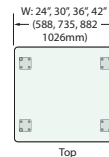
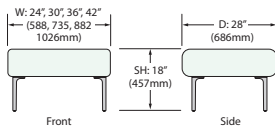
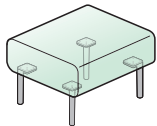

SXSN-SNN

Class QA - GSA: Open Market

Width	Number			Fabric Grade							
	1000	4	6	A	B	C	D	E	F	G	H
24"(610mm)	SXSN- OOU-24	SNN		\$ 1900.00	\$ 1935.62	\$ 1971.24	\$ 2013.98	\$ 2099.47	\$ 2206.34	\$ 2313.20	\$ 2526.92
30"(762mm)	SXSN- OOU-30	SNN		2150.36	2207.32	2264.29	2332.64	2469.35	2640.24	2811.13	3152.90
36"(914mm)	SXSN- OOU-36	SNN		2300.00	2358.80	2417.59	2488.15	2629.26	2805.65	2982.04	3334.82
42"(1067mm)	SXSN- OOU-42	SNN		2425.00	2476.37	2527.75	2589.39	2712.68	2866.80	3020.91	3329.14
48"(1219mm)	SXSN- OOU-48	SNN		2499.39	2550.76	2602.14	2663.78	2787.07	2941.19	3095.30	3403.53
54"(1372mm)	SXSN- OOU-54	SNN		2875.00	2968.31	3061.61	3173.58	3397.51	3677.42	3957.34	4517.16
60"(1524mm)	SXSN- OOU-60	SNN		3025.00	3123.51	3222.01	3340.22	3576.63	3872.14	4167.66	4758.69
66"(1676mm)	SXSN- OOU-66	SNN		3020.00	3119.70	3219.41	3339.06	3578.36	3877.48	4176.60	4774.85
72"(1829mm)	SXSN- OOU-72	SNN		3150.00	3249.70	3349.41	3469.06	3708.36	4007.48	4306.60	4904.85

**Railroad Upholstery:** To specify, change the 8th digit from U to R. Example: SXSN-200R-48MSNNF

# Moxie — Modular Lounge

Haworth/Haworth Design Studio/2026/Made in the United States

## No Back Adder

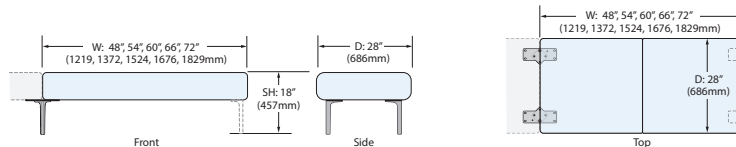
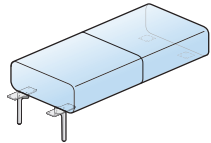
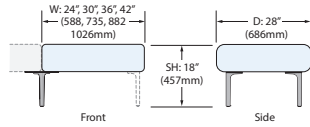
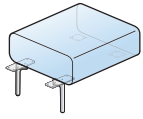

SXSN-ANN

Class QA – GSA: Open Market

Width	Number			Fabric Grade							
	1	2	3	A	B	C	D	E	F	G	H
24"(610mm)	SXSN-	00U-24	ANN	\$ 1900.00	\$ 1935.62	\$ 1971.24	\$ 2013.98	\$ 2099.47	\$ 2206.34	\$ 2313.20	\$ 2526.92
30"(762mm)	SXSN-	00U-30	ANN	2150.36	2207.32	2264.29	2332.64	2469.35	2640.24	2811.13	3152.90
36"(914mm)	SXSN-	00U-36	ANN	2300.00	2358.80	2417.59	2488.15	2629.26	2805.65	2982.04	3334.82
42"(1067mm)	SXSN-	00U-42	ANN	2425.00	2476.37	2527.75	2589.39	2712.68	2866.80	3020.91	3329.14
48"(1219mm)	SXSN-	00U-48	ANN	2499.39	2550.76	2602.14	2663.78	2787.07	2941.19	3095.30	3403.53
54"(1372mm)	SXSN-	00U-54	ANN	2875.00	2968.31	3061.61	3173.58	3397.51	3677.42	3957.34	4517.16
60"(1524mm)	SXSN-	00U-60	ANN	3025.00	3123.51	3222.01	3340.22	3576.63	3872.14	4167.66	4758.69
66"(1676mm)	SXSN-	00U-66	ANN	3020.00	3119.70	3219.41	3339.06	3578.36	3877.48	4176.60	4774.85
72"(1829mm)	SXSN-	00U-72	ANN	3150.00	3249.70	3349.41	3469.06	3708.36	4007.48	4306.60	4904.85

**Railroad Upholstery:** To specify, change the 8th digit from U to R. Example: SXSN-200R-48MANNF

## Mid-Back Starter – No Arms

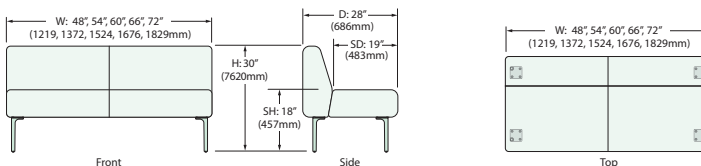
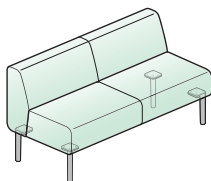
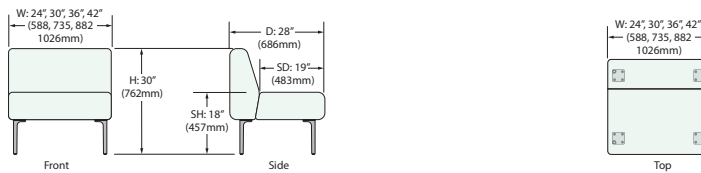
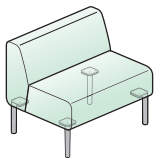

SXSM-SNN

Class QA – GSA: Open Market

Width	Number			Fabric Grade							
	1	2	3	A	B	C	D	E	F	G	H
24"(610mm)	SXSM-	00U-24	SNN	\$ 2650.36	\$ 2722.32	\$ 2794.28	\$ 2880.64	\$ 3053.35	\$ 3269.24	\$ 3485.12	\$ 3916.90
30"(762mm)	SXSM-	00U-30	SNN	3010.00	3092.75	3175.51	3274.81	3473.42	3721.69	3969.94	4466.47
36"(914mm)	SXSM-	00U-36	SNN	3299.99	3399.87	3499.77	3619.63	3859.36	4159.03	4458.69	5058.01
42"(1067mm)	SXSM-	00U-42	SNN	3500.00	3586.22	3672.42	3775.87	3982.79	4241.42	4500.05	5017.31
48"(1219mm)	SXSM-	00U-48	SNN	3700.00	3802.54	3905.06	4028.11	4274.18	4581.78	4889.38	5504.58
54"(1372mm)	SXSM-	00U-54	SNN	4125.00	4269.92	4414.84	4588.73	4936.54	5371.28	5806.03	6675.53
60"(1524mm)	SXSM-	00U-60	SNN	4350.00	4519.00	4687.99	4890.78	5296.37	5803.35	6310.33	7324.30
66"(1676mm)	SXSM-	00U-66	SNN	4465.00	4622.12	4779.25	4967.79	5344.88	5816.24	6287.60	7230.33
72"(1829mm)	SXSM-	00U-72	SNN	4650.00	4808.96	4967.91	5158.66	5540.15	6017.01	6493.88	7447.60

**Railroad Upholstery:** To specify, change the 8th digit from U to R. Example: SXSM-220R-48MSNNF

# Moxie — Modular Lounge

Haworth/Haworth Design Studio/2026/Made in the United States

## Mid-Back Adder – No Arms

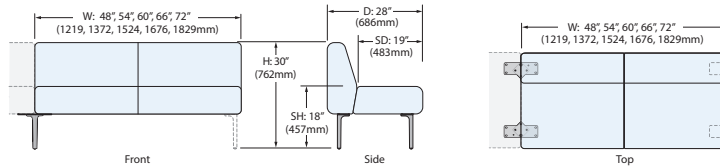
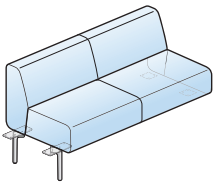
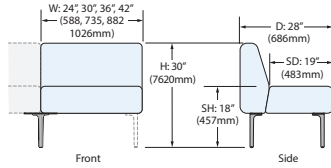
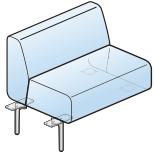

SXSM-ANN  
Class QA – GSA: Open Market

Width	Number			Fabric Grade									
	①	②	③	④	⑤	A	B	C	D	E	F	G	H
24"(610mm)	SXSM-	OU-24	ANN			\$2650.36	\$2722.32	\$2794.28	\$2880.64	\$3053.35	\$3269.24	\$3485.12	\$3916.90
30"(762mm)	SXSM-	OU-30	ANN			3010.00	3092.75	3175.51	3274.81	3473.42	3721.69	3969.94	4466.47
36"(914mm)	SXSM-	OU-36	ANN			3299.99	3399.87	3499.77	3619.63	3859.36	4159.03	4458.69	5058.01
42"(1067mm)	SXSM-	OU-42	ANN			3500.00	3586.22	3672.42	3775.87	3982.79	4241.42	4500.05	5017.31
48"(1219mm)	SXSM-	OU-48	ANN			3700.00	3802.54	3905.06	4028.11	4274.18	4581.78	4889.38	5504.58
54"(1372mm)	SXSM-	OU-54	ANN			4125.00	4269.92	4414.84	4588.73	4936.54	5371.28	5806.03	6675.53
60"(1524mm)	SXSM-	OU-60	ANN			4350.00	4519.00	4687.99	4890.78	5296.37	5803.35	6310.33	7324.30
66"(1676mm)	SXSM-	OU-66	ANN			4465.00	4622.12	4779.25	4967.79	5344.88	5816.24	6287.60	7230.33
72"(1829mm)	SXSM-	OU-72	ANN			4650.00	4808.96	4967.91	5158.66	5540.15	6017.01	6493.88	7447.60

**Railroad Upholstery:** To specify, change the 8th digit from U to R. Example: SXSM-22OR-48MANNF

# Moxie — Modular Lounge

Haworth/Haworth Design Studio/2026/Made in the United States

## Mid-Back Starter – One Arm



Left-Hand Shown

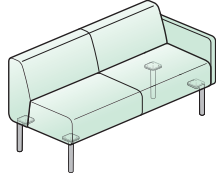
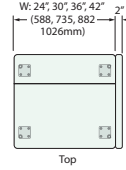
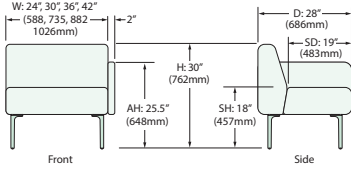

Left-Hand Shown

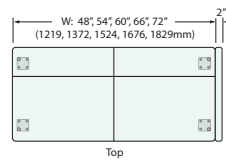
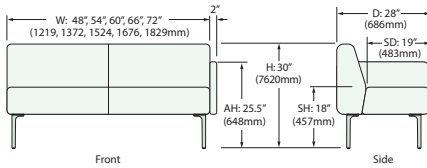

SXSM-SRN  
SXSM-SLN

Class QA – GSA: Open Market

Width	Number		Fabric Grade									
	①	②	④	⑤	A	B	C	D	E	F	G	H
<b>Right-Hand Arm</b>												
24"(610mm)	SXSM-	U-24	SRN		\$ 3100.36	\$ 3172.32	\$3244.28	\$3330.64	\$3503.35	\$ 3719.24	\$3935.12	\$4366.90
30"(762mm)	SXSM-	U-30	SRN		3460.00	3542.75	3625.51	3724.81	3923.42	4171.69	4419.94	4916.47
36"(914mm)	SXSM-	U-36	SRN		3749.99	3849.87	3949.77	4069.63	4309.36	4609.03	4908.69	5508.01
42"(1067mm)	SXSM-	U-42	SRN		3950.00	4036.22	4122.42	4225.87	4432.79	4691.42	4950.05	5467.31
48"(1219mm)	SXSM-	U-48	SRN		4150.00	4252.54	4355.06	4478.11	4724.18	5031.78	5339.38	5954.58
54"(1372mm)	SXSM-	U-54	SRN		4575.00	4719.92	4864.84	5038.73	5386.54	5821.28	6256.03	7125.53
60"(1524mm)	SXSM-	U-60	SRN		4800.00	4969.00	5137.99	5340.78	5746.37	6253.35	6760.33	7774.30
66"(1676mm)	SXSM-	U-66	SRN		4915.00	5072.12	5229.25	5417.79	5794.88	6266.24	6737.60	7680.33
72"(1829mm)	SXSM-	U-72	SRN		5100.00	5258.96	5417.91	5608.66	5990.15	6467.01	6943.88	7897.60
<b>Left-Hand Arm</b>												
24"(610mm)	SXSM-	U-24	SLN		\$ 3100.36	\$ 3172.32	\$3244.28	\$3330.64	\$3503.35	\$ 3719.24	\$3935.12	\$4366.90
30"(762mm)	SXSM-	U-30	SLN		3460.00	3542.75	3625.51	3724.81	3923.42	4171.69	4419.94	4916.47
36"(914mm)	SXSM-	U-36	SLN		3749.99	3849.87	3949.77	4069.63	4309.36	4609.03	4908.69	5508.01
42"(1067mm)	SXSM-	U-42	SLN		3950.00	4036.22	4122.42	4225.87	4432.79	4691.42	4950.05	5467.31
48"(1219mm)	SXSM-	U-48	SLN		4150.00	4252.54	4355.06	4478.11	4724.18	5031.78	5339.38	5954.58
54"(1372mm)	SXSM-	U-54	SLN		4575.00	4719.92	4864.84	5038.73	5386.54	5821.28	6256.03	7125.53
60"(1524mm)	SXSM-	U-60	SLN		4800.00	4969.00	5137.99	5340.78	5746.37	6253.35	6760.33	7774.30
66"(1676mm)	SXSM-	U-66	SLN		4915.00	5072.12	5229.25	5417.79	5794.88	6266.24	6737.60	7680.33
72"(1829mm)	SXSM-	U-72	SLN		5100.00	5258.96	5417.91	5608.66	5990.15	6467.01	6943.88	7897.60

**Railroad Upholstery:** To specify, change the 8th digit from U to R. Example: SXSM-222R-48MSRNF

**Solid Surface arm caps:** To specify, change the 14th character from N to S (add \$500.00 list) Example: SXSM-222U-48MSRSF

# Moxie — Modular Lounge

Haworth/Haworth Design Studio/2026/Made in the United States

## Mid-Back Adder – Left-Hand Arm

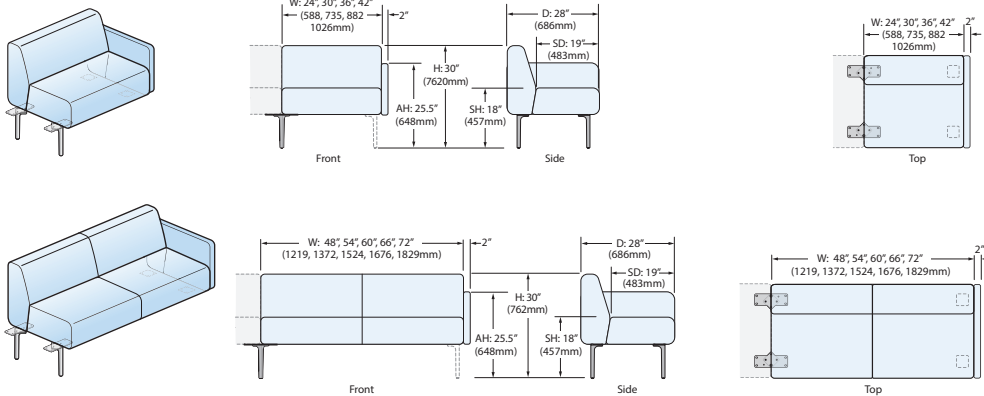

SXSM-ALN  
Class QA – GSA: Open Market

Width	Number				Fabric Grade								
	1	2	3	4	A	B	C	D	E	F	G	H	
<b>Left-Hand Arm</b>													
24\"(610mm)	SXSM-	■	■	U-24	ALN	\$ 3100.36	\$ 3172.32	\$3244.28	\$3330.64	\$3503.35	\$ 3719.24	\$ 3935.12	\$4366.90
30\"(762mm)	SXSM-	■	■	U-30	ALN	3460.00	3542.75	3625.51	3724.81	3923.42	4171.69	4419.94	4916.47
36\"(914mm)	SXSM-	■	■	U-36	ALN	3749.99	3849.87	3949.77	4069.63	4309.36	4609.03	4908.69	5508.01
42\"(1067mm)	SXSM-	■	■	U-42	ALN	3950.00	4036.22	4122.42	4225.87	4432.79	4691.42	4950.05	5467.31
48\"(1219mm)	SXSM-	■	■	U-48	ALN	4150.00	4252.54	4355.06	4478.11	4724.18	5031.78	5339.38	5954.58
54\"(1372mm)	SXSM-	■	■	U-54	ALN	4575.00	4719.92	4864.84	5038.73	5386.54	5821.28	6256.03	7125.53
60\"(1524mm)	SXSM-	■	■	U-60	ALN	4800.00	4969.00	5137.99	5340.78	5746.37	6253.35	6760.33	7774.30
66\"(1676mm)	SXSM-	■	■	U-66	ALN	4915.00	5072.12	5229.25	5417.79	5794.88	6266.24	6737.60	7680.33
72\"(1829mm)	SXSM-	■	■	U-72	ALN	5100.00	5258.96	5417.91	5608.66	5990.15	6467.01	6943.88	7897.60

**Railroad Upholstery:** To specify, change the 8th digit from U to R. Example: SXSM-222R-48MALNF

**Solid Surface arm caps:** To specify, change the 14th character from N to S (add \$500.00 list) Example: SXSM-222U-48MALSF

# Moxie — Modular Lounge

Haworth/Haworth Design Studio/2026/Made in the United States

## Mid-Back Starter – Both Arms

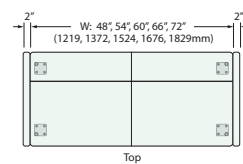
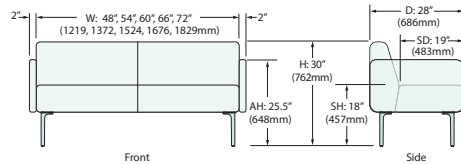
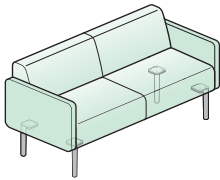
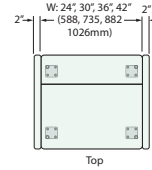
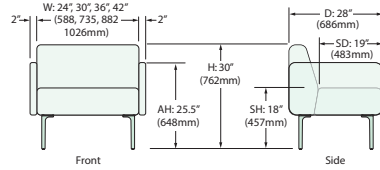
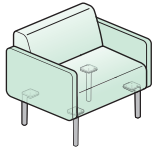

SXSM-SBN  
Class QA – GSA: Open Market

Width	Number				Fabric Grade								
	1	2	3	4	A	B	C	D	E	F	G	H	
24"(610mm)	SXSM-	■	■	U-24	SBN	\$ 3550.36	\$ 3622.32	\$ 3694.28	\$ 3780.64	\$ 3953.35	\$ 4169.24	\$ 4385.12	\$ 4816.90
30"(762mm)	SXSM-	■	■	U-30	SBN	3910.00	3992.75	4075.51	4174.81	4373.42	4621.69	4869.94	5366.47
36"(914mm)	SXSM-	■	■	U-36	SBN	4199.99	4299.87	4399.77	4519.63	4759.36	5059.03	5358.69	5958.01
42"(1067mm)	SXSM-	■	■	U-42	SBN	4400.00	4486.22	4572.42	4675.87	4882.79	5141.42	5400.05	5917.31
48"(1219mm)	SXSM-	■	■	U-48	SBN	4600.00	4702.54	4805.06	4928.11	5174.18	5481.78	5789.38	6404.58
54"(1372mm)	SXSM-	■	■	U-54	SBN	5025.00	5169.92	5314.84	5488.73	5836.54	6271.28	6706.03	7575.53
60"(1524mm)	SXSM-	■	■	U-60	SBN	5250.00	5419.00	5587.99	5790.78	6196.37	6703.35	7210.33	8224.30
66"(1676mm)	SXSM-	■	■	U-66	SBN	5365.00	5522.12	5679.25	5867.79	6244.88	6716.24	7187.60	8130.33
72"(1829mm)	SXSM-	■	■	U-72	SBN	5550.00	5708.96	5867.91	6058.66	6440.15	6917.01	7393.88	8347.60

**Railroad Upholstery:** To specify, change the 8th digit from U to R. Example: SXSM-222R-48MSBNF

**Solid Surface arm caps:** To specify, change the 14th character from N to S (add \$500.00 list per arm) Example: SXSM-222U-48MSBSF

# Moxie — Modular Lounge

Haworth/Haworth Design Studio/2026/Made in the United States

## High-Back Starter – No Arms

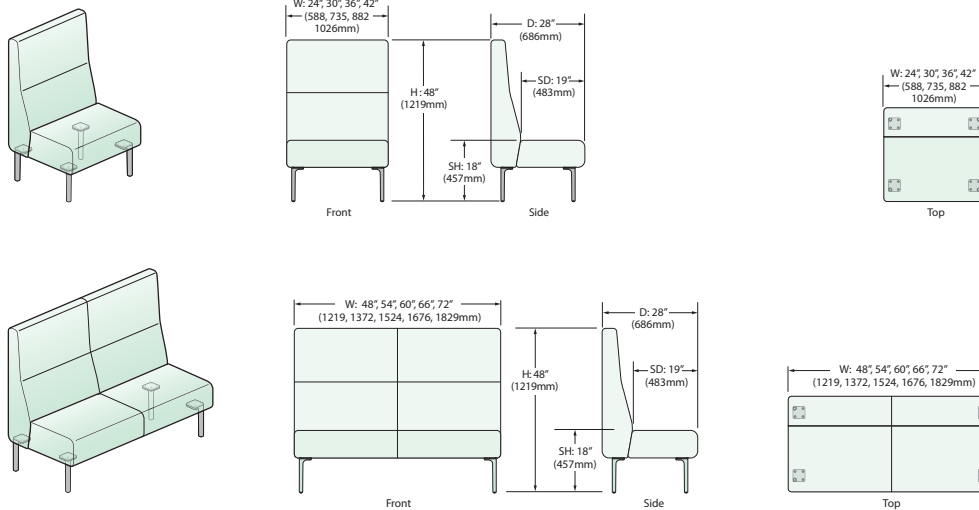

SXSH-SNN  
Class QA – GSA: Open Market

Width	Number				Fabric Grade							
	①	②	③	④	A	B	C	D	E	F	G	H
24"(610mm)	SXSH-	0U-24	SNN		\$3050.00	\$ 3135.04	\$ 3220.07	\$ 3322.13	\$ 3526.22	\$ 3781.34	\$4036.44	\$4546.67
30"(762mm)	SXSH-	0U-30	SNN		3400.00	3503.37	3606.75	3730.80	3978.89	4289.02	4599.14	5219.40
36"(914mm)	SXSH-	0U-36	SNN		3925.00	4036.33	4147.68	4281.29	4548.50	4882.52	5216.54	5884.59
42"(1067mm)	SXSH-	0U-42	SNN		4350.00	4462.16	4574.31	4708.89	4978.06	5314.51	5650.97	6323.87
48"(1219mm)	SXSH-	0U-48	SNN		4650.00	4779.23	4908.45	5063.53	5373.67	5761.34	6149.02	6924.37
54"(1372mm)	SXSH-	0U-54	SNN		5025.00	5226.58	5428.16	5670.05	6153.84	6758.58	7363.31	8572.78
60"(1524mm)	SXSH-	0U-60	SNN		5275.00	5477.87	5680.74	5924.18	6411.07	7019.69	7628.30	8845.53
66"(1676mm)	SXSH-	0U-66	SNN		5450.00	5659.33	5868.67	6119.87	6622.27	7250.28	7878.28	9134.29
72"(1829mm)	SXSH-	0U-72	SNN		5580.00	5794.24	6008.46	6265.55	6779.71	7422.42	8065.12	9350.52

**Railroad Upholstery:** To specify, change the 8th digit from U to R. Example: SXSH-22OR-48MSNNF

# Moxie — Modular Lounge

Haworth/Haworth Design Studio/2026/Made in the United States

## High-Back Adder – No Arms

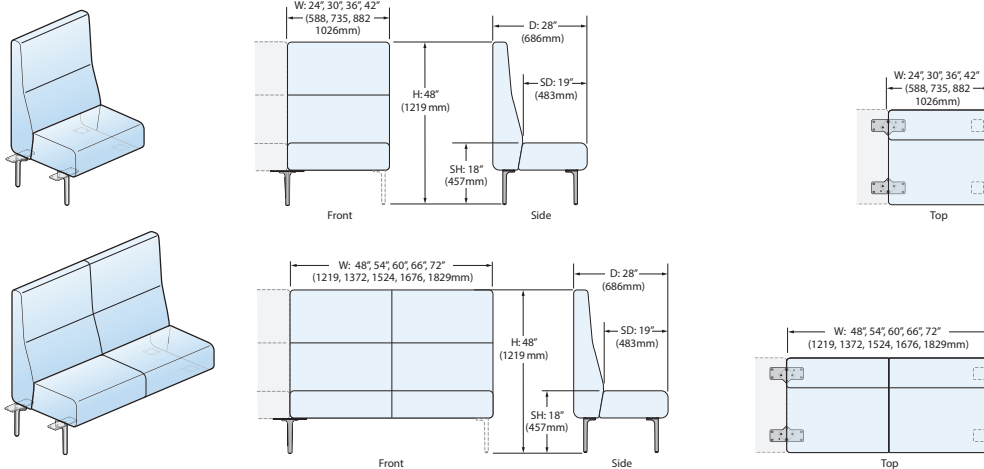

SXSH-ANN  
Class QA – GSA: Open Market

Width	Number					Fabric Grade							
	1	2	3	4	5	A	B	C	D	E	F	G	H
24\"(610mm)	SXSH-	OU-24	ANN			\$3050.00	\$ 3135.04	\$ 3220.07	\$ 3322.13	\$ 3526.22	\$ 3781.34	\$ 4036.44	\$ 4546.67
30\"(762mm)	SXSH-	OU-30	ANN			3400.00	3503.37	3606.75	3730.80	3978.89	4289.02	4599.14	5219.40
36\"(914mm)	SXSH-	OU-36	ANN			3925.00	4036.33	4147.68	4281.29	4548.50	4882.52	5216.54	5884.59
42\"(1067mm)	SXSH-	OU-42	ANN			4350.00	4462.16	4574.31	4708.89	4978.06	5314.51	5650.97	6323.87
48\"(1219mm)	SXSH-	OU-48	ANN			4650.00	4779.23	4908.45	5063.53	5373.67	5761.34	6149.02	6924.37
54\"(1372mm)	SXSH-	OU-54	ANN			5025.00	5226.58	5428.16	5670.05	6153.84	6758.58	7363.31	8572.78
60\"(1524mm)	SXSH-	OU-60	ANN			5275.00	5477.87	5680.74	5924.18	6411.07	7019.69	7628.30	8845.53
66\"(1676mm)	SXSH-	OU-66	ANN			5450.00	5659.33	5868.67	6119.87	6622.27	7250.28	7878.28	9134.29
72\"(1829mm)	SXSH-	OU-72	ANN			5580.00	5794.24	6008.46	6265.55	6779.71	7422.42	8065.12	9350.52

**Railroad Upholstery:** To specify, change the 8th digit from U to R. Example: SXSH-220R-48MANNF

# Moxie — Modular Lounge

Haworth/Haworth Design Studio/2026/Made in the United States

## High-Back Starter – One Arm

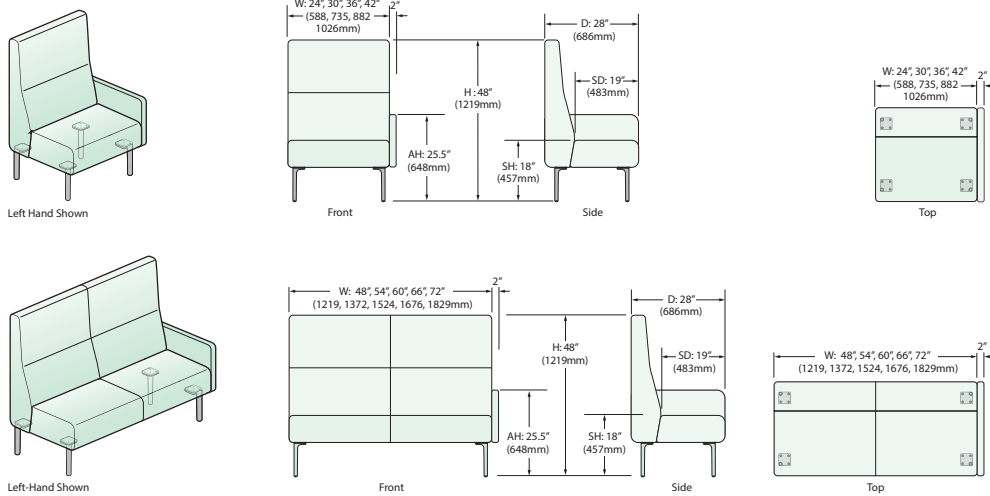

SXSH-SLN  
Class QA – GSA: Open Market

Width	Number		Fabric Grade		A	B	C	D	E	F	G	H
	①	②	④	⑤								
<b>Right-Hand Arm</b>												
24\" (610mm)	SXSH-	U-24	SRN		\$3500.00	\$3585.04	\$3670.07	\$3772.13	\$3976.22	\$4231.34	\$4486.44	\$4996.67
30\" (762mm)	SXSH-	U-30	SRN		3850.00	3953.37	4056.75	4180.80	4428.89	4739.02	5049.14	5669.40
36\" (914mm)	SXSH-	U-36	SRN		4375.00	4486.33	4597.68	4731.29	4998.50	5332.52	5666.54	6334.59
42\" (1067mm)	SXSH-	U-42	SRN		4800.00	4912.16	5024.31	5158.89	5428.06	5764.51	6100.97	6773.87
48\" (1219mm)	SXSH-	U-48	SRN		5100.00	5229.23	5358.45	5513.53	5823.67	6211.34	6599.02	7374.37
54\" (1372mm)	SXSH-	U-54	SRN		5475.00	5676.58	5878.16	6120.05	6603.84	7208.58	7813.31	9022.78
60\" (1524mm)	SXSH-	U-60	SRN		5725.00	5927.87	6130.74	6374.18	6861.07	7469.69	8078.30	9295.53
66\" (1676mm)	SXSH-	U-66	SRN		5900.00	6109.33	6318.67	6569.87	7072.27	7700.28	8328.28	9584.29
72\" (1829mm)	SXSH-	U-72	SRN		6030.00	6244.24	6458.46	6715.55	7229.71	7872.42	8515.12	9800.52
<b>Left-Hand Arm</b>												
24\" (610mm)	SXSH-	U-24	SLN		\$3500.00	\$3585.04	\$3670.07	\$3772.13	\$3976.22	\$4231.34	\$4486.44	\$4996.67
30\" (762mm)	SXSH-	U-30	SLN		3850.00	3953.37	4056.75	4180.80	4428.89	4739.02	5049.14	5669.40
36\" (914mm)	SXSH-	U-36	SLN		4375.00	4486.33	4597.68	4731.29	4998.50	5332.52	5666.54	6334.59
42\" (1067mm)	SXSH-	U-42	SLN		4800.00	4912.16	5024.31	5158.89	5428.06	5764.51	6100.97	6773.87
48\" (1219mm)	SXSH-	U-48	SLN		5100.00	5229.23	5358.45	5513.53	5823.67	6211.34	6599.02	7374.37
54\" (1372mm)	SXSH-	U-54	SLN		5475.00	5676.58	5878.16	6120.05	6603.84	7208.58	7813.31	9022.78
60\" (1524mm)	SXSH-	U-60	SLN		5725.00	5927.87	6130.74	6374.18	6861.07	7469.69	8078.30	9295.53
66\" (1676mm)	SXSH-	U-66	SLN		5900.00	6109.33	6318.67	6569.87	7072.27	7700.28	8328.28	9584.29
72\" (1829mm)	SXSH-	U-72	SLN		6030.00	6244.24	6458.46	6715.55	7229.71	7872.42	8515.12	9800.52

**Railroad Upholstery:** To specify, change the 8th digit from U to R. Example: SXSH-222R-48MSRNF

**Solid Surface arm caps:** To specify, change the 14th character from N to S (add \$500.00 list) Example: SXSH-222U-48MSBSF

# Moxie — Modular Lounge

Haworth/Haworth Design Studio/2026/Made in the United States

## High-Back Adder – Left-Hand Arm

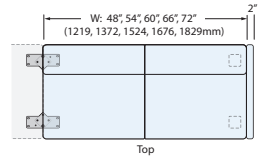
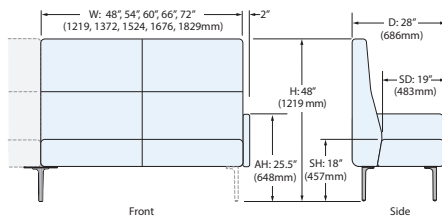
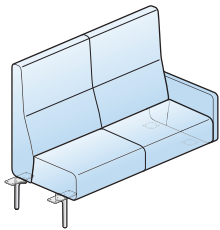
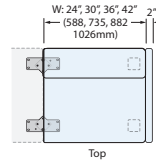
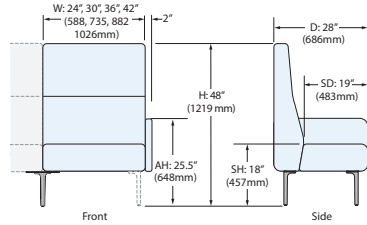
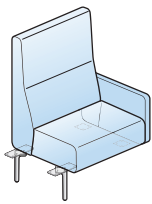

SXSH-ALN

Class QA – GSA: Open Market

Width	Number			Fabric Grade							
	①②③	④	⑤	A	B	C	D	E	F	G	H
<b>Left-Hand Arm</b>											
24"(610mm)	SXSH-	U-24	ALN	\$3500.00	\$3585.04	\$3670.07	\$3772.13	\$3976.22	\$4231.34	\$4486.44	\$4996.67
30"(762mm)	SXSH-	U-30	ALN	3850.00	3953.37	4056.75	4180.80	4428.89	4739.02	5049.14	5669.40
36"(914mm)	SXSH-	U-36	ALN	4375.00	4486.33	4597.68	4731.29	4998.50	5332.52	5666.54	6334.59
42"(1067mm)	SXSH-	U-42	ALN	4800.00	4912.16	5024.31	5158.89	5428.06	5764.51	6100.97	6773.87
48"(1219mm)	SXSH-	U-48	ALN	5100.00	5229.23	5358.45	5513.53	5823.67	6211.34	6599.02	7374.37
54"(1372mm)	SXSH-	U-54	ALN	5475.00	5676.58	5878.16	6120.05	6603.84	7208.58	7813.31	9022.78
60"(1524mm)	SXSH-	U-60	ALN	5725.00	5927.87	6130.74	6374.18	6861.07	7469.69	8078.30	9295.53
66"(1676mm)	SXSH-	U-66	ALN	5900.00	6109.33	6318.67	6569.87	7072.27	7700.28	8328.28	9584.29
72"(1829mm)	SXSH-	U-72	ALN	6030.00	6244.24	6458.46	6715.55	7229.71	7872.42	8515.12	9800.52

**Railroad Upholstery:** To specify, change the 8th digit from U to R. Example: SXSH-222R-48MALNF

**Solid Surface arm caps:** To specify, change the 14th character from N to S (add \$500.00 list) Example: SXSH-222U-48MALSF

# Moxie — Modular Lounge

Haworth/Haworth Design Studio/2026/Made in the United States

## High-Back Starter – Both Arms

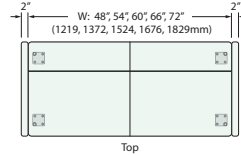
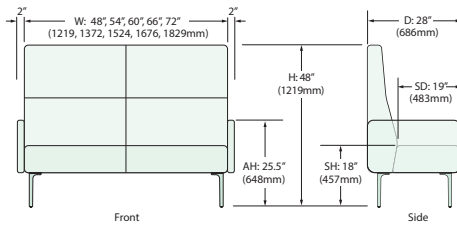
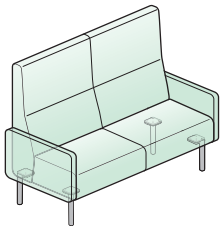
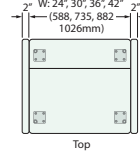
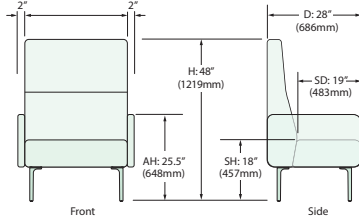
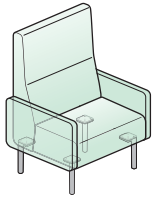

SXSH-SBN

Class QA – GSA: Open Market

Width	Number		Fabric Grade								
	①	②	④	⑤	A	B	C	D	E	F	G
24"(610mm)	SXSH-	U-24	SBN	\$3950.00	\$4035.04	\$4120.07	\$4222.13	\$4426.22	\$4681.34	\$4936.44	\$5446.67
30"(762mm)	SXSH-	U-30	SBN	4300.00	4403.37	4506.75	4630.80	4878.89	5189.02	5499.14	6119.40
36"(914mm)	SXSH-	U-36	SBN	4825.00	4936.33	5047.68	5181.29	5448.50	5782.52	6116.54	6784.59
42"(1067mm)	SXSH-	U-42	SBN	5250.00	5362.16	5474.31	5608.89	5878.06	6214.51	6550.97	7223.87
48"(1219mm)	SXSH-	U-48	SBN	5550.00	5679.23	5808.45	5963.53	6273.67	6661.34	7049.02	7824.37
54"(1372mm)	SXSH-	U-54	SBN	5925.00	6126.58	6328.16	6570.05	7053.84	7658.58	8263.31	9472.78
60"(1524mm)	SXSH-	U-60	SBN	6175.00	6377.87	6580.74	6824.18	7311.07	7919.69	8528.30	9745.53
66"(1676mm)	SXSH-	U-66	SBN	6350.00	6559.33	6768.67	7019.87	7522.27	8150.28	8778.28	10034.29
72"(1829mm)	SXSH-	U-72	SBN	6480.00	6694.24	6908.46	7165.55	7679.71	8322.42	8965.12	10250.52

**Railroad Upholstery:** To specify, change the 8th digit from U to R. Example: SXSH-222R-48MSBNF

**Solid Surface arm caps:** To specify, change the 14th character from N to S (add \$500.00 list per arm) Example: SXSH-222U-48MSBSF

# Moxie — Modular Lounge

Haworth/Haworth Design Studio/2026/Made in the United States

## Curved Lounge

### Unique Features

- 90° Concave Units and 45° Convex Units
- Arm Options - Not available.
- Legs:
  - Starter - Five legs and spacer brackets.
  - Adder - Three legs, one spacer bracket and two shared leg brackets.
- All units will have a center seam.

### To Order, Specify:

- Product number, including:
  - 1 Seat material:**
    - 2 Woven Fabric
    - 3 Coated Fabric
  - 2 Back Material (if applicable):**
    - 2 Woven Fabric
    - 3 Coated Fabric
  - 3 Leg Style:**
    - M Metal
    - W Wood (add **\$400.00** List)
  - 4 Glide Style:**
    - H Hard Plastic
    - F Felt
- Seat material and color.
- Back material and color (if applicable).
- Leg color/finish.

## 90° Concave Starter - No Back

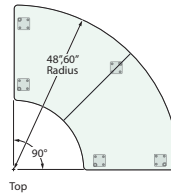
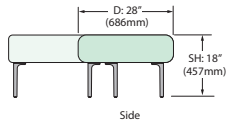
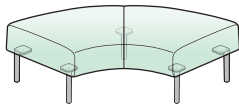

SXCN-S  
Class QA – GSA: Open Market

Outside Radius	Number			Fabric Grade							
	12	3	4	A	B	C	D	E	F	G	H
48"(1219mm)	SXCN-00U-48	SNN		\$3450.00	\$3531.40	\$3612.80	\$3710.49	\$3719.85	\$4150.05	\$4394.26	\$4882.66
60"(1524mm)	SXCN-00U-60	SNN		3925.00	4009.74	4094.48	4196.16	4399.53	4653.74	4907.96	5416.38

**Railroad Upholstery:** To specify, change the 8th digit from U to R. Example: SXCN-200R-48MSNNF

## 90° Concave Adder - No Back

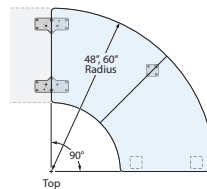
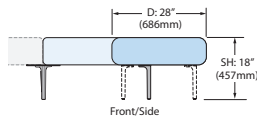
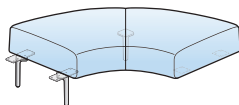

SXCN-A  
Class QA – GSA: Open Market

Outside Radius	Number			Fabric Grade							
	12	3	4	A	B	C	D	E	F	G	H
48"(1219mm)	SXCN-00U-48	ANN		\$3450.00	\$3531.40	\$3612.80	\$3710.49	\$3719.85	\$4150.05	\$4394.26	\$4882.66
60"(1524mm)	SXCN-00U-60	ANN		3925.00	4009.74	4094.48	4196.16	4399.53	4653.74	4907.96	5416.38

**Railroad Upholstery:** To specify, change the 8th digit from U to R. Example: SXCN-200R-48MANNF

# Moxie — Modular Lounge

Haworth/Haworth Design Studio/2026/Made in the United States

## 90° Concave Starter - Mid-Back

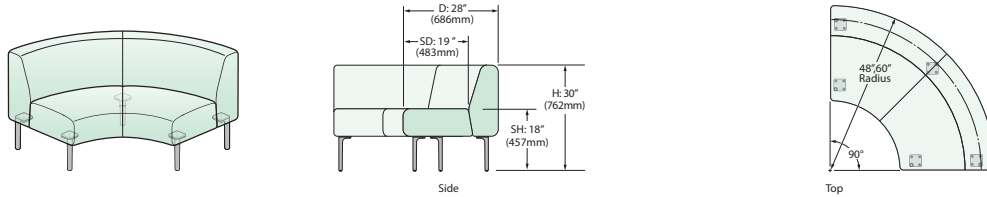

SXCM-S  
Class QA – GSA: Open Market

Outside Radius	Number				Fabric Grade							
	①	②	③	④	A	B	C	D	E	F	G	H
48"(1219mm)	SXCM-	OU-48	SNN		\$4825.00	\$4997.78	\$5170.56	\$5377.90	\$5792.58	\$6310.92	\$6829.27	\$7865.96
60"(1524mm)	SXCM-	OU-60	SNN		5925.00	6115.72	6306.45	6535.32	6993.07	7565.26	8137.43	9281.80

**Railroad Upholstery:** To specify, change the 8th digit from U to R. Example: SXCM-220R-48MSNNF

## 90° Concave Adder - Mid-Back

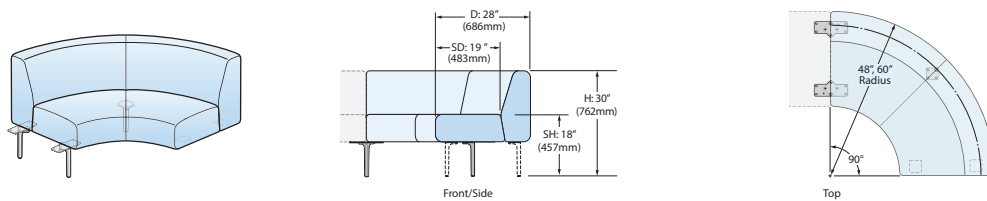

SXCM-A  
Class QA – GSA: Open Market

Outside Radius	Number				Fabric Grade							
	①	②	③	④	A	B	C	D	E	F	G	H
48"(1219mm)	SXCM-	OU-48	ANN		\$4825.00	\$4997.78	\$5170.56	\$5377.90	\$5792.58	\$6310.92	\$6829.27	\$7865.96
60"(1524mm)	SXCM-	OU-60	ANN		5925.00	6115.72	6306.45	6535.32	6993.07	7565.26	8137.43	9281.80

**Railroad Upholstery:** To specify, change the 8th digit from U to R. Example: SXCM-220R-48MANNF

## 90° Concave Starter - High-Back

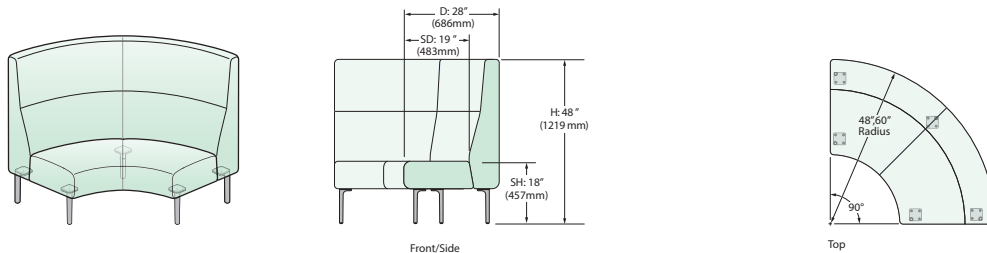

SXCH-S  
Class QA – GSA: Open Market

Outside Radius	Number				Fabric Grade							
	①	②	③	④	A	B	C	D	E	F	G	H
48"(1219mm)	SXCH-	OU-48	SNN		\$5900.00	\$6118.26	\$6336.52	\$6598.44	\$7122.27	\$7777.05	\$8431.84	\$9741.41
60"(1524mm)	SXCH-	OU-60	SNN		6775.00	6995.04	7215.07	7479.12	8007.21	8667.31	9327.41	10647.63

**Railroad Upholstery:** To specify, change the 8th digit from U to R. Example: SXCH-220R-48MSNNF

# Moxie — Modular Lounge

Haworth/Haworth Design Studio/2026/Made in the United States

## 90° Concave Adder - High-Back

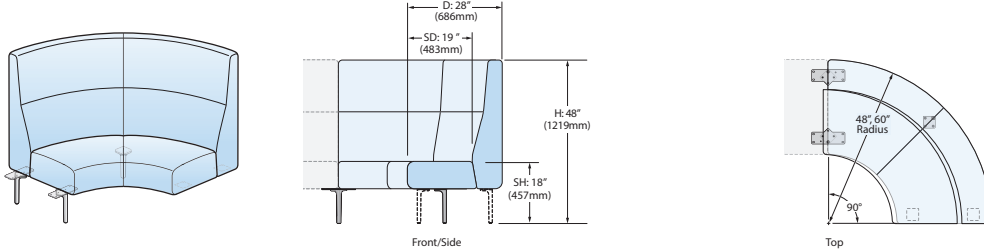

SXCH-A  
Class QA – GSA: Open Market

Outside Radius	Number				Fabric Grade							
	①	②	③	④	A	B	C	D	E	F	G	H
48" (1219mm)	SXCH-	OU-48	ANN		\$5900.00	\$ 618.26	\$6336.52	\$6598.44	\$ 7122.27	\$7777.05	\$8431.84	\$ 9741.41
60" (1524mm)	SXCH-	OU-60	ANN		6775.00	6995.04	7215.07	7479.12	8007.21	8667.31	9327.41	10647.63

**Railroad Upholstery:** To specify, change the 8th digit from U to R. Example: SXCH-220R-48MANNF

## 45° Convex Starter - No Back

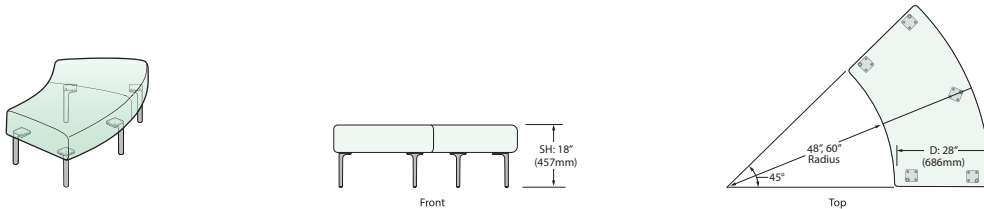

SXVN-S  
Class QA – GSA: Open Market

Inside Radius	Number				Fabric Grade							
	①	②	③	④	A	B	C	D	E	F	G	H
48" (1219mm)	SXVN-	00U-48	SNN		\$ 3275.00	\$ 3347.62	\$3420.24	\$ 3507.39	\$ 3681.69	\$3899.56	\$ 4117.43	\$4553.17
60" (1524mm)	SXVN-	00U-60	SNN		3564.00	3658.06	3752.12	3864.98	4090.72	4372.89	4655.06	5219.39

**Railroad Upholstery:** To specify, change the 8th digit from U to R. Example: SXVN-200R-48MSNNF

## 45° Convex Adder - No Back

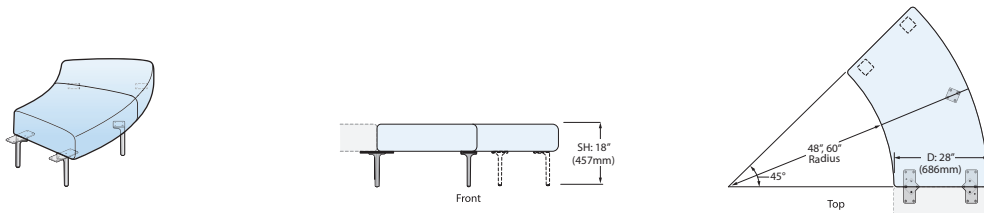

SXVN-A  
Class QA – GSA: Open Market

Inside Radius	Number				Fabric Grade							
	①	②	③	④	A	B	C	D	E	F	G	H
48" (1219mm)	SXVN-	00U-48	ANN		\$ 3275.00	\$ 3347.62	\$3420.24	\$ 3507.39	\$ 3681.69	\$3899.56	\$ 4117.43	\$4553.17
60" (1524mm)	SXVN-	00U-60	ANN		3564.00	3658.06	3752.12	3864.98	4090.72	4372.89	4655.06	5219.39

**Railroad Upholstery:** To specify, change the 8th digit from U to R. Example: SXVN-200R-48MANNF

# Moxie — Modular Lounge

Haworth/Haworth Design Studio/2026/Made in the United States

## 45° Convex Starter - Mid-Back

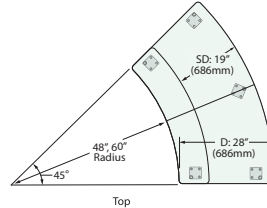
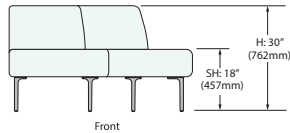
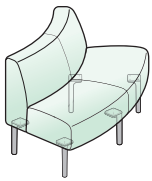

SXVM-S  
Class QA – GSA: Open Market

Inside Radius	Number				Fabric Grade							
	①②	③	④		A	B	C	D	E	F	G	H
48"(1219mm)	SXVM-■	OU-48	SNN	■	\$4375.00	\$4489.65	\$4604.30	\$ 4741.87	\$5017.03	\$5360.96	\$5704.90	\$6392.79
60"(1524mm)	SXVM-■	OU-60	SNN	■	4925.00	5049.41	5173.83	5323.13	5621.73	5994.98	6368.23	7114.73

**Railroad Upholstery:** To specify, change the 8th digit from U to R. Example: SXVM-220R-48MSNNF

## 45° Convex Adder - Mid-Back

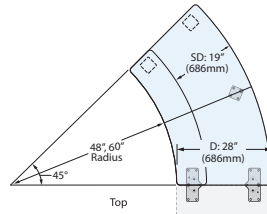
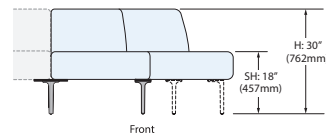
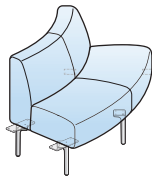

SXVM-A  
Class QA – GSA: Open Market

Inside Radius	Number				Fabric Grade							
	①②	③	④		A	B	C	D	E	F	G	H
48"(1219mm)	SXVM-■	OU-48	ANN	■	\$4375.00	\$4489.65	\$4604.30	\$ 4741.87	\$5017.03	\$5360.96	\$5704.90	\$6392.79
60"(1524mm)	SXVM-■	OU-60	ANN	■	4925.00	5049.41	5173.83	5323.13	5621.73	5994.98	6368.23	7114.73

**Railroad Upholstery:** To specify, change the 8th digit from U to R. Example: SXVM-220R-48MANNF

## 45° Convex Starter - High-Back

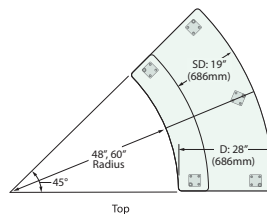
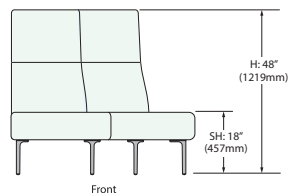
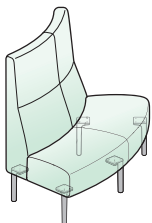

SXVH-S  
Class QA – GSA: Open Market

Inside Radius	Number				Fabric Grade							
	①②	③	④		A	B	C	D	E	F	G	H
48"(1219mm)	SXVH-■	OU-48	SNN	■	\$5150.00	\$5286.95	\$5423.90	\$5588.25	\$ 5916.93	\$6327.78	\$6738.63	\$7560.34
60"(1524mm)	SXVH-■	OU-60	SNN	■	5725.00	5874.51	6024.03	6203.45	6562.29	7010.84	7459.38	8356.48

**Railroad Upholstery:** To specify, change the 8th digit from U to R. Example: SXVH-220R-48MSNNF

# Moxie — Modular Lounge

Haworth/Haworth Design Studio/2026/Made in the United States

## 45° Convex Adder - High-Back

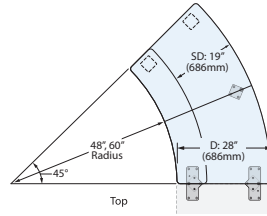
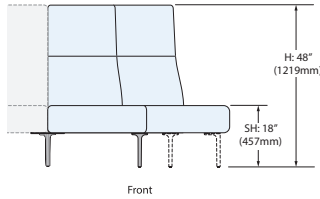
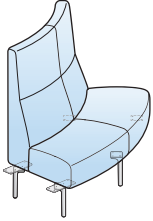

SXVH-A  
Class QA – GSA: Open Market

Inside Radius	Number	Fabric Grade										
		①②	③	④	A	B	C	D	E	F	G	H
48"(1219mm)	SXVH-■ OU-48 ANN■				\$5150.00	\$5286.95	\$5423.90	\$5588.25	\$5916.93	\$6327.78	\$6738.63	\$7560.34
60"(1524mm)	SXVH-■ OU-60 ANN■				5725.00	5874.51	6024.03	6203.45	6562.29	7010.84	7459.38	8356.48

**Railroad Upholstery:** To specify, change the 8th digit from U to R. Example: SXVH-220R-48MANNF

# Moxie — Modular Lounge

Haworth/Haworth Design Studio/2026/Made in the United States

## Square Corner Lounge

### Unique Features

- Arms - Not available.
- Legs:
  - Starter - Four legs and spacer brackets.
  - Adder - Three legs, one spacer bracket, two shared leg brackets and one corner shared leg bracket.
- Seat handedness determines direction of the upholstery.
- Two sides of the unit will be flat to provide clean lines when adjacent to another unit.

### To Order, Specify:

- Product number, including:
  - 1 Seat Handedness:**
    - L** Left-Hand
    - R** Right-Hand
  - 2 Seat material:**
    - 2** Woven Fabric
    - 3** Coated Fabric
  - 3 Back Material (if applicable):**
    - 2** Woven Fabric
    - 3** Coated Fabric
  - 4 Leg Style:**
    - M** Metal
    - W** Wood (add **\$400.00** List)
  - 5 Glide Style:**
    - H** Hard Plastic
    - F** Felt
- Seat material and color.
- Back material and color (if applicable).
- Leg color/finish.

## Starter - No Back

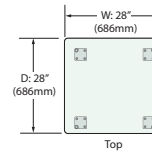
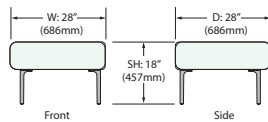
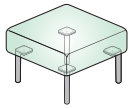

SXN-SNN  
Class QA – GSA: Open Market

Width	Number				Fabric Grade							
	1	2③	4	6	A	B	C	D	E	F	G	H
28" (711mm)	SX	N-	00U-28	SNN	\$1975.00	\$2029.98	\$2084.96	\$2150.93	\$2282.88	\$2447.82	\$2612.75	\$2942.63

**Railroad Upholstery:** To specify, change the 8th digit from U to R. Example: SXLN-200R-28MSNNF

## Adder - No Back

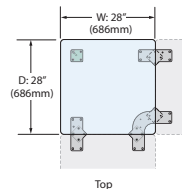
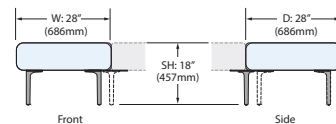
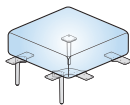

SXN-ANN  
Class QA – GSA: Open Market

Width	Number				Fabric Grade							
	1	2③	4	6	A	B	C	D	E	F	G	H
28" (711mm)	SX	N-	00U-28	ANN	\$1850.00	\$1904.98	\$1959.96	\$2025.93	\$2157.88	\$2322.82	\$2487.75	\$2817.63

**Railroad Upholstery:** To specify, change the 8th digit from U to R. Example: SXLN-200R-28MANNF

# Moxie — Modular Lounge

Haworth/Haworth Design Studio/2026/Made in the United States

## Starter - Mid Back

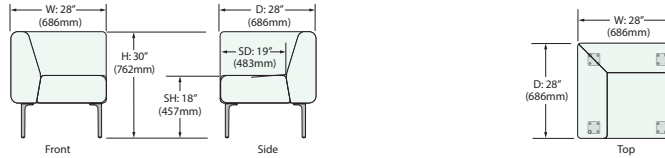
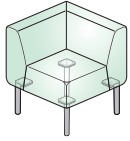

SXM-SNN

Class QA – GSA: Open Market

Width	Number				Fabric Grade							
	①	②③	④	⑤	A	B	C	D	E	F	G	H
28" (711mm)	SX	M-	OU-28	SNN	\$3575.78	\$3663.79	\$3751.81	\$3857.42	\$4068.65	\$4332.70	\$4596.74	\$5124.83

**Railroad Upholstery:** To specify, change the 8th digit from U to R. Example: SXML-220R-28MSNNF

## Adder - Mid Back

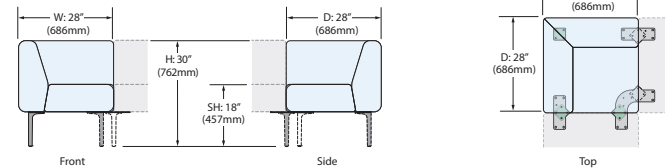
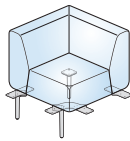

SXM-ANN

Class QA – GSA: Open Market

Width	Number				Fabric Grade							
	①	②③	④	⑤	A	B	C	D	E	F	G	H
28" (711mm)	SX	M-	OU-28	ANN	\$3450.78	\$3538.79	\$3626.81	\$3732.42	\$3943.65	\$4207.70	\$4471.74	\$4999.83

**Railroad Upholstery:** To specify, change the 8th digit from U to R. Example: SXML-220R-28MANNF

## Starter - High Back

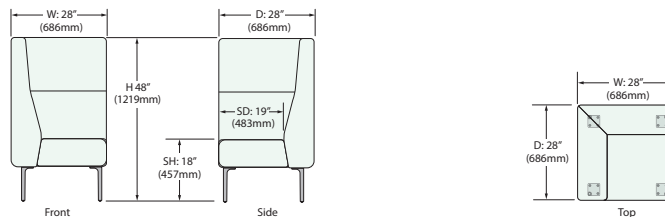
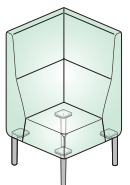

SXH-SNN

Class QA – GSA: Open Market

Width	Number				Fabric Grade							
	①	②③	④	⑤	A	B	C	D	E	F	G	H
28" (711mm)	SX	H-	OU-28	SNN	\$4500.00	\$4616.66	\$4733.32	\$4873.31	\$5153.30	\$5503.28	\$5853.26	\$6553.23

**Railroad Upholstery:** To specify, change the 8th digit from U to R. Example: SXLH-220R-28MSNNF

# Moxie — Modular Lounge

Haworth/Haworth Design Studio/2026/Made in the United States

## Adder - High Back

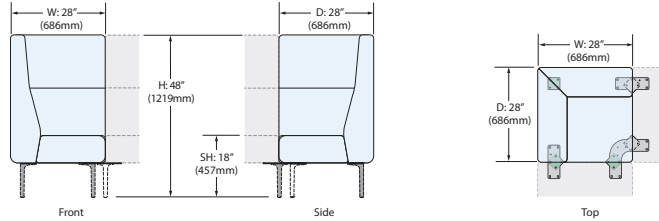
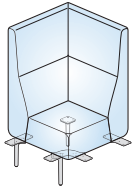

SXH-ANN

Class QA – GSA: Open Market

Width	Number					Fabric Grade							
	①	②	③	④	⑤	A	B	C	D	E	F	G	H
28"(711mm)	SX	H-	OU-28	ANN		\$4375.00	\$4491.66	\$4608.32	\$4748.31	\$5028.30	\$5378.28	\$5728.26	\$6428.23

**Railroad Upholstery:** To specify, change the 8th digit from U to R. Example: SXLH-220R-28MANNF

# Moxie — Modular Lounge

Haworth/Haworth Design Studio/2026/Made in the United States

## Half-Round Lounge

### Unique Features

- Available in No Back or Mid-Back only.
- Arms - Not available.
- Legs:
  - Starter -
    - No Back will have four legs and four spacer brackets.
    - Mid-Back will have five legs and five spacer brackets.
  - Adder -
    - No Back will have four legs, three spacer brackets and one shared leg bracket.
    - Mid-Back will have five legs, four spacer brackets and one shared leg bracket.
- 57"(1448mm) Half-Round allows for direct back-to-back seating with a 1"(25mm) gap.
- 68"(1727mm) Half-Round provides space between back-to-back units with a 12"(305mm) gap.
- Half-Round units not for use with screens.

### To Order, Specify:

- Product number, including:
  - 1 Seat material:**
    - 2 Woven Fabric
    - 3 Coated Fabric
  - 2 Back Material (if applicable):**
    - 2 Woven Fabric
    - 3 Coated Fabric
  - 3 Leg Style:**
    - M Metal
    - W Wood (add \$400.00 List)
  - 4 Glide Style:**
    - H Hard Plastic
    - F Felt
- Seat material and color.
- Back material and color (if applicable).
- Leg color/finish.

### Starter - No Back

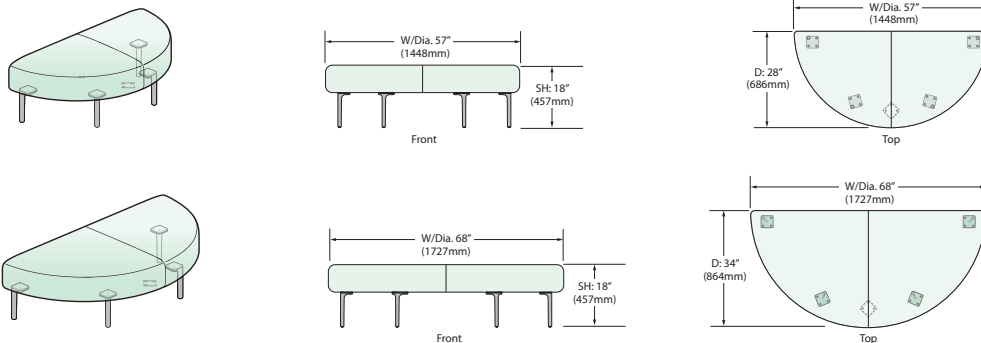

SXHN-SNN  
Class QA – GSA: Open Market

Width	Number				Fabric Grade							
	1	2	3	4	A	B	C	D	E	F	G	H
57"(1448mm)	SXHN-	00U-57	SNN		\$3242.77	\$3302.26	\$ 3361.75	\$3433.13	\$3575.90	\$3754.36	\$3932.83	\$4289.75
68"(1727mm)	SXHN-	00U-68	SNN		3942.67	4020.94	4099.22	4193.15	4381.01	4615.83	4850.66	5320.31

**Railroad Upholstery:** To specify, change the 8th digit from U to R. Example: SXHN-200R-57MSNNF

# Moxie — Modular Lounge

Haworth/Haworth Design Studio/2026/Made in the United States

## Adder - No Back

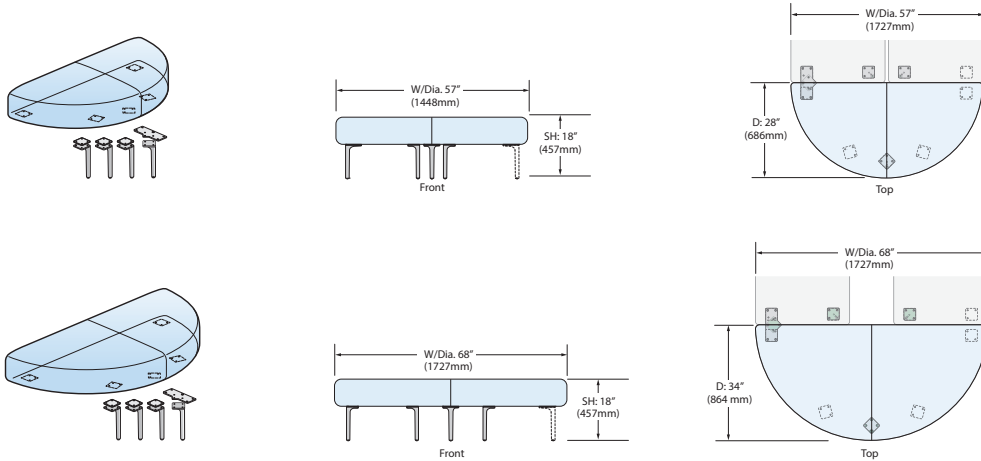

SXHN-ANN  
Class QA – GSA: Open Market

Width	Number				Fabric Grade							
	①②	③	④		A	B	C	D	E	F	G	H
57"(1448mm)	SXHN-00U-57	ANN			\$3242.77	\$3302.26	\$3361.75	\$3433.13	\$3575.90	\$3754.36	\$3932.83	\$4289.75
68"(1727mm)	SXHN-00U-68	ANN			3942.67	4020.94	4099.22	4193.15	4381.01	4615.83	4850.66	5320.31

**Railroad Upholstery:** To specify, change the 8th digit from U to R. Example: SXHN-200R-68MANNF

## Starter - Mid-Back

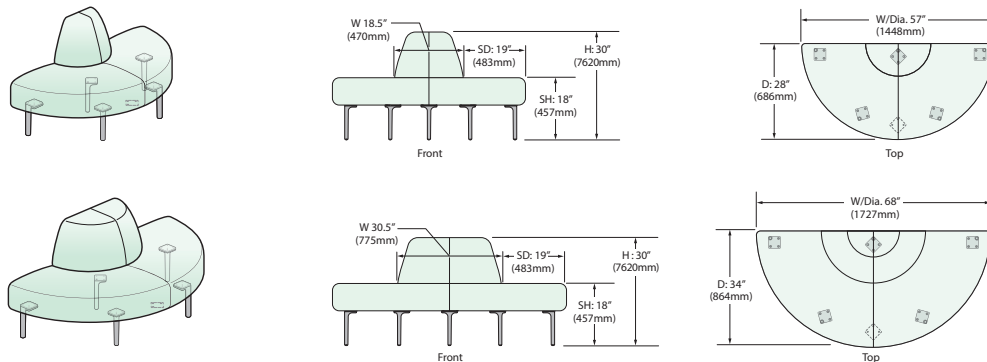

SXHM-SNN  
Class QA – GSA: Open Market

Width	Number				Fabric Grade							
	①②	③	④		A	B	C	D	E	F	G	H
57"(1448mm)	SXHM-OU-57	SNN			\$3967.67	\$4063.41	\$4159.15	\$4274.04	\$4503.81	\$4791.03	\$5078.25	\$5652.69
68"(1727mm)	SXHM-OU-68	SNN			4542.67	4670.02	4799.38	4953.40	5261.45	5646.52	6031.58	6801.70

**Railroad Upholstery:** To specify, change the 8th digit from U to R. Example: SXHM-220R-57MSNNF

# Moxie — Modular Lounge

Haworth/Haworth Design Studio/2026/Made in the United States

## Adder - Mid-Back

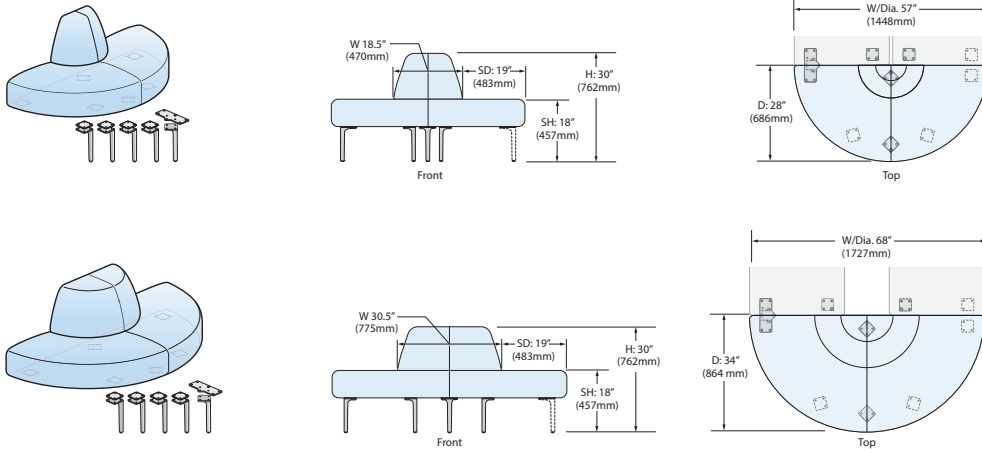

SXHM-ANN  
Class QA – GSA: Open Market

Width	Number				Fabric Grade							
	①	②	③	④	A	B	C	D	E	F	G	H
57"(1448mm)	SXHM-	OU-57	ANN		\$3967.67	\$4063.41	\$4159.15	\$4274.04	\$4503.81	\$4791.03	\$5078.25	\$5652.69
68"(1727mm)	SXHM-	OU-68	ANN		4542.67	4670.02	4799.38	4953.40	5261.45	5646.52	6031.58	6801.70

**Railroad Upholstery:** To specify, change the 8th digit from U to R. Example: SXHM-220R-57MANNF

## Intermediate Arm

### Features

- Includes one arm and mounting bracket.
- Provides separation and arm rest between two seating units with backs.
- Mounting bracket is standard in black and mounts to left-hand seat.
- Solid Surface arm cap is available; modification of product number is required. Available in White SS-CW only.
- Patterned material will not be pattern matched.

### To Order, Specify:

1) Product number, including:

**① Arm Material:**

- ②** Woven Fabric
- ③** Coated Fabric

2) Arm material and color.

3) Arm cap color (if applicable).  
SS-CW White

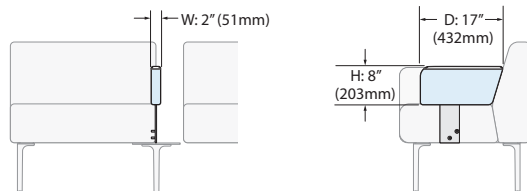
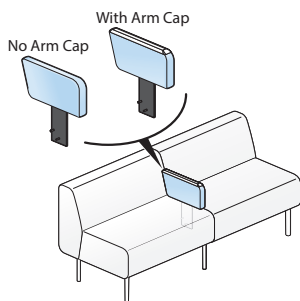

SXAA  
Class QA – GSA: Open Market

Height	Depth	Width	Number		Fabric							
			①	A	B	C	D	E	F	G	H	
7.5"(191mm)	16.75"(425mm)	2"(51mm)	SXAA-	N	\$650.00	\$659.09	\$665.15	\$674.24	\$692.42	\$715.14	\$737.87	\$783.31

**Solid Surface arm caps:** To specify, change the last character from N to S (add \$500.00 list) Example: SXAA-2S

# Moxie — Modular Lounge

Haworth/Haworth Design Studio/2026/Made in the United States

## Intermediate Tablet

### Features

- Includes one oval or round tablet and mounting bracket.
- Mounts between two seating units with backs.
- Mounting bracket is standard in black and mounts to left-hand seat.
- Tablet is available in high-pressure laminate (HPL) or solid surface.
- Laminate tablet will have a knife edge and is available in select laminates only.
- Solid surface tablet is available in White SS-CW only.
- Tablet is 6.75"(171mm) from seat cushion.

### To Order, Specify:

- 1) Product number.
- 2) Surface color.
  - HPL
  - H-C8 Blonde Modern Cherry
  - H-8J Charcoal
  - H-KM Landmark Wood
  - H-WL Linen
  - H-D2 Mocha Modern Cherry
  - H-KL Neo Walnut
  - H-C9 Spiced Modern Cherry
  - Solid Surface
  - SS-CW White

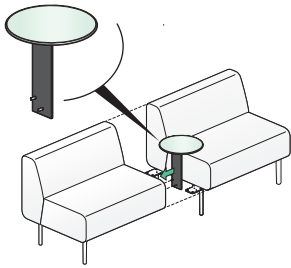

SXRT

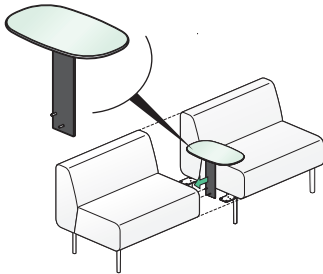
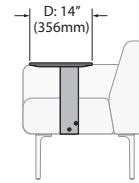
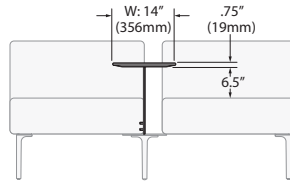

SXOT

Class QA – GSA: Open Market

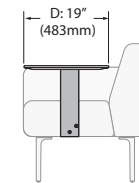
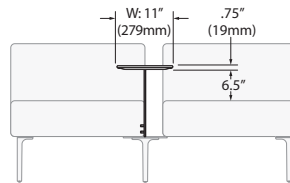

Description	Depth	Width	Number	Price
<b>Round</b>				
Laminate	14"(356mm)	14"(356mm)	SXRT-L	\$1675.00
Solid Surface			SXRT-S	2625.00
<b>Oval</b>				
Laminate	19"(483mm)	11.5"(292mm)	SXOT-L	\$900.00
Solid Surface			SXOT-S	2550.00

# Moxie — Modular Lounge

Haworth/Haworth Design Studio/2026/Made in the United States

## Screens

- Screens are designed to provide an element of privacy and are non-structural and non-load bearing.
- Screens are available on both starter and adder straight, curved and square corner units.
- Screens available on mid-back units only.
- Specified screen width must match seat width. Arm specification will determine actual screen width.
- Overall height is 48"(1219mm) from floor.
- Return depth is 20"(508mm).
- Screen thickness is 0.5"(13mm).
- Screen upholstery is applied Railroaded.
- Patterned materials will not be pattern matched.
- Separately specified alignment clips are required between multiple screens.

## Straight Screen

### Features

- Arm location is determined from a seated position.
- Arm specification (Option 2) is required to ensure the screen will cover the total width of the unit. Specification of arms will dynamically increase screen width to cover the entire back.

### To Order, Specify:

1) Product number, including:

**1 Screen material:**

- 2** Woven Fabric
- 3** Coated Fabric

**2 Arm Location:**

- N** No Arm
- L** LH Arm
- R** RH Arm
- B** LH and RH Arms

2) Screen material and color.

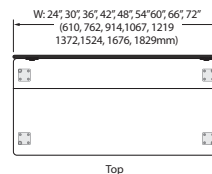
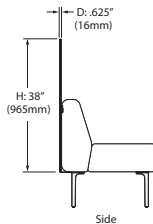
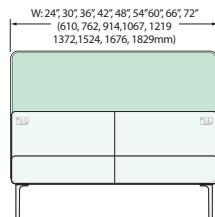
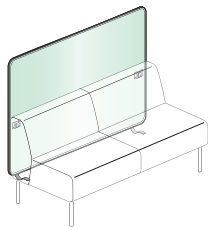

SXSS-M  
Class QA – GSA: Open Market

Seat Width	Number	Fabric Grade									
		<b>1</b>	<b>2</b>	<b>A</b>	<b>B</b>	<b>C</b>	<b>D</b>	<b>E</b>	<b>F</b>	<b>G</b>	<b>H</b>
24"(610mm)	SXSS- <b>M24-N</b>			\$ 961.95	\$ 976.71	\$ 992.55	\$ 1014.15	\$1035.75	\$1064.55	\$1082.55	\$ 1111.35
30"(762mm)	SXSS- <b>M30-N</b>			938.05	956.50	976.30	1003.30	1030.30	1066.30	1088.80	1124.80
36"(914mm)	SXSS- <b>M36-N</b>			1025.00	1047.14	1070.90	1103.30	1135.70	1178.90	1205.90	1249.10
42"(1067mm)	SXSS- <b>M42-N</b>			1150.00	1175.83	1203.55	1241.35	1279.15	1329.55	1361.05	1411.45
48"(1219mm)	SXSS- <b>M48-N</b>			1250.00	1279.52	1311.20	1354.40	1397.60	1455.20	1491.20	1548.80
54"(1372mm)	SXSS- <b>M54-N</b>			1350.00	1383.21	1418.85	1467.45	1516.05	1580.85	1621.35	1686.15
60"(1524mm)	SXSS- <b>M60-N</b>			1400.00	1436.90	1476.50	1530.50	1584.50	1656.50	1701.50	1773.50
66"(1676mm)	SXSS- <b>M66-N</b>			1550.00	1590.59	1634.15	1693.55	1752.95	1832.15	1881.65	1960.85
72"(1829mm)	SXSS- <b>M72-N</b>			1910.00	1954.28	2001.80	2066.60	2131.40	2217.80	2271.80	2358.20

# Moxie — Modular Lounge

Haworth/Haworth Design Studio/2026/Made in the United States

## Straight Screen with Return

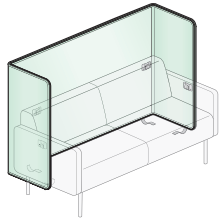

### Features

- For use on Straight Starter or Adder units with arm(s).
- Screens are available with a left-hand or right-hand return creating an L-shape or both left- and right-hand returns creating a U-shape.
- Returns can only be specified where an arm is present.
- Return and arm handedness is determined from a seated position.

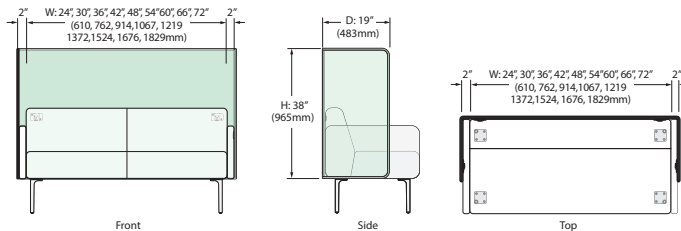

### To Order, Specify:

1) Product number, including:

**1 Screen material:**

- 2** Woven Fabric
- 3** Coated Fabric

**2 Screen Return:**

- LL** LH Return/LH Arm
- LB** LH Return/LH and RH Arms
- RR** RH Return/RH Arm
- RB** RH Return/LH and RH Arms
- BB** LH and RH Return/LH and RH Arm

2) Screen material and color.

SXSS-M

Class QA – GSA: Open Market

Seat Width	Number		Fabric Grade							
	①	②	A	B	C	D	E	F	G	H
24"(610mm)	SXSS-	M24-	\$ 1511.95	\$ 1538.94	\$ 1567.90	\$ 1607.39	\$ 1646.88	\$ 1699.54	\$ 1732.45	\$ 1785.10
30"(762mm)	SXSS-	M30-	1488.05	1518.73	1551.65	1596.54	1641.43	1701.29	1738.70	1798.55
36"(914mm)	SXSS-	M36-	1575.00	1609.37	1646.25	1696.54	1746.83	1813.89	1855.80	1922.85
42"(1067mm)	SXSS-	M42-	1700.00	1738.06	1778.90	1834.59	1890.28	1964.54	2010.95	2085.20
48"(1219mm)	SXSS-	M48-	1800.00	1841.75	1886.55	1947.64	2008.73	2090.19	2141.10	2222.55
54"(1372mm)	SXSS-	M54-	1900.00	1945.44	1994.20	2060.69	2127.18	2215.84	2271.25	2359.90
60"(1524mm)	SXSS-	M60-	1950.00	1999.13	2051.85	2123.74	2195.63	2291.49	2351.40	2447.25
66"(1676mm)	SXSS-	M66-	2100.00	2152.82	2209.50	2286.79	2364.08	2467.14	2531.55	2634.60
72"(1829mm)	SXSS-	M72-	2460.00	2516.51	2577.15	2659.84	2742.53	2852.79	2921.70	3031.95

## Curved Screen

### Unique Features

- Curved screens require use of alignment clips between multiple screens; separately specified.

Note: 60"(1524mm) radius concave screen will be a two piece screen. All other curved screens will be one piece.

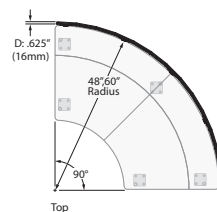
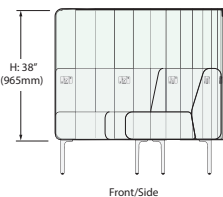
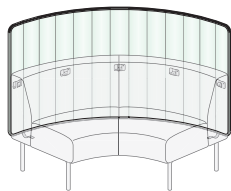

### To Order, Specify:

1) Product number, including:

**1 Curve Type:**

- C** Concave
- V** Convex

**2 Screen material:**

- 2** Woven Fabric
- 3** Coated Fabric

2) Screen material and color.

SXCS

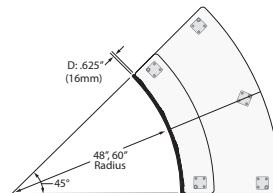

SXVS

Class QA – GSA: Open Market

Radius	Number		Fabric Grade							
	①	②	A	B	C	D	E	F	G	H
48"(1219mm)	SX	S- M48-NO	\$ 1857.54	\$ 1904.76	\$ 1955.43	\$ 2024.52	\$ 2093.61	\$ 2185.74	\$ 2243.31	\$ 2335.44
60"(1524mm)	SX	S- M60-NO	2457.54	2486.35	2517.27	2559.44	2601.60	2657.82	2692.96	2749.18

# Moxie — Modular Lounge

Haworth/Haworth Design Studio/2026/Made in the United States

## Square Corner Screen

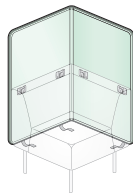
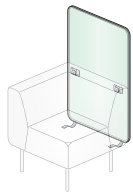

### Unique Feature

- Screen handedness determined from a seated position.

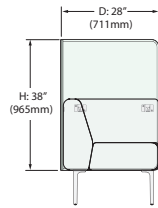
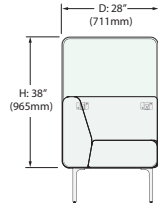

### To Order, Specify:

- 1) Product number, including:

#### 1 Screen material:

- 2 Woven Fabric
- 3 Coated Fabric

#### 2 Screen Handedness:

- L Left-Hand
- R Right-Hand

- 2) Screen material and color.

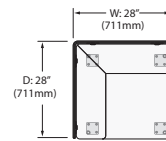
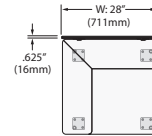

SXQS  
Class QA – GSA: Open Market

Description	Width	Number		Fabric Grade								
		1	2	A	B	C	D	E	F	G	H	
LH or RH	28"(711mm)	SXQS-	M28-	O	\$ 975.00	\$ 992.22	\$1010.70	\$1035.90	\$1061.10	\$1094.70	\$1115.70	\$1149.30
Both LH/RH	28"(711mm)	SXQS-	M28-	B0	\$1450.00	\$1484.44	\$1521.40	\$ 1571.80	\$1622.20	\$1689.40	\$1731.40	\$1798.60

## Screen Alignment Clip

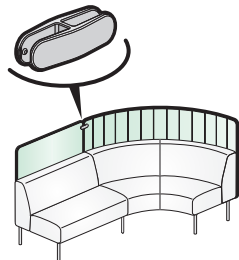

### Features

- Includes one clip.
- One clip is required between each screen pairing.

### To Order, Specify:

- 1) Product number.
- 2) Surface color.  
TR-K Charcoal  
TR-PLS Plaster

Description	Depth	Width	Number	Price
1"(25mm)	0.5"(13mm)	3.5"(89mm)	SXG-10	\$25.00

SXG-10  
Class QA – GSA: Open Market

# Moxie — Modular Lounge

Haworth/Haworth Design Studio/2026/Made in the United States

## Tables

- Tables are available as round, square corner and rectangle.
- Tables available in High-Pressure Laminate (HPL) or Solid Surface.
- Laminate top thickness is 1.18"(30mm) with 1mm edgeband on all sides.
- Solid surface tops are 1"(25mm) thick with 5mm edge radius. Solid surface tops available in White SS-CW only.
- Legs 10"(254mm)H available in painted metal or wood.
- Glides available in hard plastic or felt and provide 0.5"(13mm) leveling adjustment.
- Tables not for use with screens, intermediate arm or intermediate tablet.
- Power module can be attached under HPL surface. Cannot be attached to Solid Surface table top.

## Rectangle Table

### Unique Features

- Rectangle tables available as starter tables and adder tables.
  - Starter:
    - Includes four legs and four spacer brackets.
    - Can be used as stand alone table or connected to Moxie seating units.
  - Adder:
    - 28"(711mm)W Adder table includes two legs and two shared leg brackets.
    - 57"(1448mm)W and 68"(1727mm)W Adder tables includes four legs and four spacer brackets.

### To Order, Specify:

1) Product number, including:

**1 Table Type:**

- L** HPL
- S** Solid Surface

**2 Leg Style:**

- M** Metal
- W** Wood (add **\$400.00** List)

**3 Glide Style:**

- H** Hard Plastic
- F** Felt

2) Top surface/color.







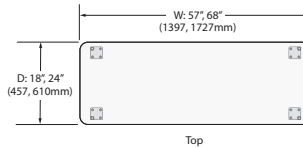
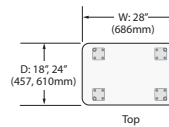
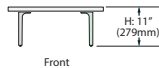
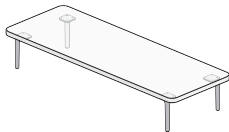
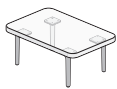













3) Edgeband color (if applicable).

4) Leg color/finish.

## Starter



SXRT-S  
Class QA – GSA: Open Market

Depth	Width	Number  	HPL A	HPL B	Solid Surface
18"(457mm)	28"(711mm)	SXRT-1828-   S 	\$ 950.00	\$ 957.88	\$2350.00
	57"(1448mm)	SXRT-1857-   S 	931.10	931.10	931.10
	68"(1727mm)	SXRT-1868-   S 	1450.00	1469.13	5423.00
24"(610mm)	28"(711mm)	SXRT-2428-   S 	\$ 1150.00	\$ 1160.50	\$2943.70
	57"(1448mm)	SXRT-2457-   S 	1250.00	1271.38	5242.60
	68"(1727mm)	SXRT-2468-   S 	992.30	1017.80	5825.00

# Moxie — Modular Lounge

Haworth/Haworth Design Studio/2026/Made in the United States

## Adder

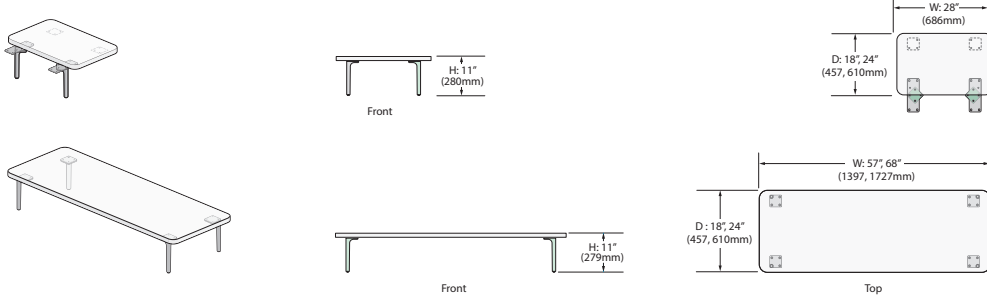

SXRT-A  
Class QA – GSA: Open Market

Depth	Width	Number ① ② ③	HPL A	HPL B	Solid Surface
18"(457mm)	28"(711mm)	SXRT-1828-■ ■ A ■	\$ 950.00	\$ 957.88	\$2350.00
	57"(1448mm)	SXRT-1857-■ ■ A ■	931.10	931.10	931.10
	68"(1727mm)	SXRT-1868-■ ■ A ■	1450.00	1469.13	5423.00
24"(610mm)	28"(711mm)	SXRT-2428-■ ■ A ■	\$ 1150.00	\$ 1160.50	\$2943.70
	57"(1448mm)	SXRT-2457-■ ■ A ■	1250.00	1271.38	5242.60
	68"(1727mm)	SXRT-2468-■ ■ A ■	992.30	1017.80	5825.00

# Moxie — Modular Lounge

Haworth/Haworth Design Studio/2026/Made in the United States

## Square Corner Table

### Unique Features

- Square Corner tables available as starter tables and adder tables.
  - Starter:
    - Includes four legs and four spacer brackets.
    - Can be used as stand alone table or connected to Moxie seating units.
  - Adder:
    - Includes three legs, one spacer bracket, two shared leg brackets, and one corner shared leg bracket.
    - Adder table must be attached to a Moxie seating unit.

### To Order, Specify:

1) Product number, including:

**1 Table Type:**

- L** HPL
- S** Solid Surface

**2 Leg Style:**

- M** Metal
- W** Wood (add **\$400.00** List)

**3 Glide Style:**

- H** Hard Plastic
- F** Felt

2) Top surface/color.

3) Edgeband color (if applicable).

4) Leg color/finish.

### Starter

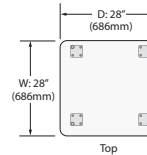
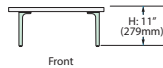
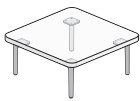

SXQT-S  
Class QA – GSA: Open Market

Depth	Width	Number 02 0	HPL A	HPL B	Solid Surface
28"(711mm)	28"(711mm)	SXQT-2828- <span style="background-color: #cccccc; border: 1px solid black; padding: 0 2px;"> </span> <span style="background-color: #cccccc; border: 1px solid black; padding: 0 2px;"> </span> <b>S</b> <span style="background-color: #cccccc; border: 1px solid black; padding: 0 2px;"> </span>	\$1025.00	\$1037.25	\$3114.50

### Adder

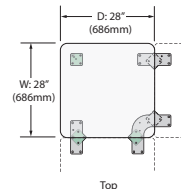
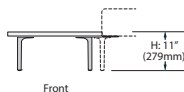
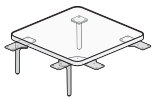

SXQT-A  
Class QA – GSA: Open Market

Depth	Width	Number 02 0	HPL A	HPL B	Solid Surface
28"(711mm)	28"(711mm)	SXQT-2828- <span style="background-color: #cccccc; border: 1px solid black; padding: 0 2px;"> </span> <span style="background-color: #cccccc; border: 1px solid black; padding: 0 2px;"> </span> <b>A</b> <span style="background-color: #cccccc; border: 1px solid black; padding: 0 2px;"> </span>	\$1025.00	\$1037.25	\$3114.50

# Moxie — Modular Lounge

Haworth/Haworth Design Studio/2026/Made in the United States

## Round Table

### Unique Features

- Round tables are available as starter stand alone tables only.
- Round tables cannot be attached to other products.
- Each table will have four legs and four spacer brackets.

### To Order, Specify:

1) Product number, including:

**1 Table Type:**

- L** HPL
- S** Solid Surface

**2 Leg Style:**

- M** Metal
- W** Wood (add **\$400.00** List)

**3 Glide Style:**

- H** Hard Plastic
- F** Felt

2) Top surface/color.

3) Edgeband color (if applicable).

4) Leg color/finish.

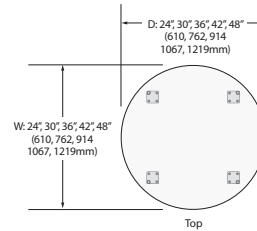
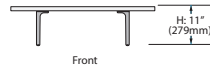
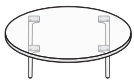

SXDT-S

Class QA – GSA: Open Market

Depth	Width	Number	HPL A	HPL B	Solid Surface
24"(610mm)	24"(610mm)	SXDT-2424-   S	\$ 975.01	\$ 982.07	\$ 2750.01
30"(762mm)	30"(762mm)	SXDT-3030-   S	1025.01	1036.05	3500.01
36"(914mm)	36"(914mm)	SXDT-3636-   S	1100.00	1115.91	4300.00
42"(1067mm)	42"(1067mm)	SXDT-4242-   S	1250.00	1271.65	5425.00
48"(1219mm)	48"(1219mm)	SXDT-4848-   S	1375.01	1403.29	6600.01

# Moxie — Modular Lounge

## Power Module

### Corded

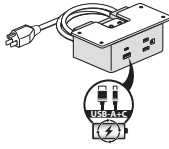

EUSM-PFOW-1100  
EUSM-PLOW-1100

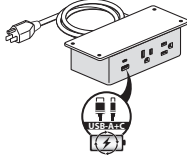

EUSM-PFOW-2100  
EUSM-PLOW-2100



Class QA

### Features

- Includes power module, two cord management clips, mounting brackets and attachment hardware.
- Power module consists of either one or two simplex outlets (NEMA-5-15R) and one dual USB A-C. (20W shared between A and C.)

### Specification Tips

- Power module attaches to the front edge of the components.
- Power modules cannot be daisy chained together.
- Application may require approval from local authority having jurisdiction (AHJ); ensure compliance before placing orders and installing.

### To Order, Specify:

1) Product number, including:

**1** Color:

**B** Black

**W** White

Description	Number	Price
<b>6'(1829mm) Cord</b>		
One Simplex Outlet	EUSM-PFO <span style="background-color: #cccccc;">■</span> -1100	\$ 673.44
Two Simplex Outlets	EUSM-PFO <span style="background-color: #cccccc;">■</span> -2100	690.45
<b>12'(3658mm) Cord</b>		
One Simplex Outlet	EUSM-PLO <span style="background-color: #cccccc;">■</span> -1100	\$ 724.53
Two Simplex Outlets	EUSM-PLO <span style="background-color: #cccccc;">■</span> -2100	741.54

### Hardwire

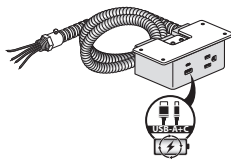

EUSM-HFOW-1100  
EUSM-HLOW-1100

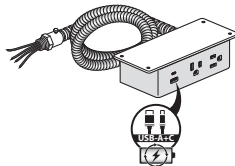

EUSM-HFOW-2100  
EUSM-HLOW-2100



Class QA

### Features

- Includes power module, two cord management clips, mounting brackets and attachment hardware.
- Power module consists of either one or two simplex outlets (NEMA-5-15R) and one dual USB A-C. (20W shared between A and C.)

### Specification Tips

- Power module attaches to the front edge of the components.
- Power modules cannot be daisy chained together.
- Application may require approval from local authority having jurisdiction (AHJ); ensure compliance before placing orders and installing.

### To Order, Specify:

1) Product number, including:

**1** Color:

**B** Black

**W** White

Description	Number	Price
<b>6'(1829mm) Cord</b>		
One Simplex Outlet	EUSM-HFO <span style="background-color: #cccccc;">■</span> -1100	\$ 801.32
Two Simplex Outlets	EUSM-HFO <span style="background-color: #cccccc;">■</span> -2100	818.33
<b>12'(3658mm) Cord</b>		
One Simplex Outlet	EUSM-HLO <span style="background-color: #cccccc;">■</span> -1100	\$852.41
Two Simplex Outlets	EUSM-HLO <span style="background-color: #cccccc;">■</span> -2100	869.42

# Haworth Moxie Resources

Surfaces Materials

Index

Warranty

# Surface Materials

## Finish Color Legend

### Trim

TR-K	Charcoal
TR-BG	Light Bronze
TR-LE	Metallic Silver
TR-1N	Night
TR-PLS	Smooth Plaster

### Wood

M7-W35	Clear on Ash
M7-W43	Ink on Ash
M7-W12	Walnut on Ash

### Solid Surface

SS-CW	White
-------	-------

### HPL

#### Grade A

##### Solid Color

H-34	Beige
H-AK	Chalk
H-8J	Charcoal
H-3J	Graphite
H-62	Gray Tone
H-WL	Linen
H-3P	Platinum
H-AA	Putty
H-3E	Smoke

##### Patterned

H-P1	Linen Casual
H-P2	Linen Classic
H-P3	Linen Crisp
H-P4	Linen Flax

##### Wood Grain

H-B06	Brazilwood
H-E79	Colombian Walnut
H-AE	Maple
H-DYP	New Age Oak
H-E15	River Cherry
H-C09	Williamsburg Cherry

#### Grade B

##### Premium Wood Grain

H-C8	Blonde Modern Cherry
H-D1	Daintree
H-KP	Field Elm
H-KN	Grey Elm
H-KM	Landmark
H-D2	Mocha Modern Cherry
H-KL	Neo Walnut
H-KR	Phantom Ecrú
H-KS	Phantom Pearl
H-C9	Spiced Modern Cherry

### Edgeband

##### Solid Color

HP-34	Beige
HP-AK	Chalk
HP-8J	Charcoal
HP-3J	Graphite
HP-62	Gray Tone
HP-WL	Linen
HP-3P	Platinum
HP-AA	Putty
HP-3E	Smoke

##### Patterned

HP-P1	Linen Casual
HP-P2	Linen Classic
HP-P3	Linen Crisp
HP-P4	Linen Flax

##### Wood Grain

HP-C8	Blonde Modern Cherry
HP-B06	Brazilwood
HP-E79	Colombian Walnut
HP-D1	Daintree
HP-KP	Field Elm
HP-KN	Grey Elm
HP-KM	Landmark
HP-AE	Maple
HP-D2	Mocha Modern Cherry
HP-KL	Neo Walnut
HP-DYP	New Age Oak
HP-KR	Phantom Ecrú
HP-KS	Phantom Pearl
HP-E15	River Cherry
HP-C9	Spiced Modern Cherry
HP-C09	Williamsburg Cherry

##### Ply-Edge

HP-PW	Ply-Edge
-------	----------

\*For most current finish and fabric availability please reference [surfaces.haworth.com](https://surfaces.haworth.com).

# Surface Materials

## Fabrics/Color Legend

### Seating Fabrics

#### Grade A

- (4H) Blanket
- (3J) Hobson
- (3L) Novelty
- (3A) Tellure
- (XJ) Wellington

#### Grade B

- (4Z) Element
- (S6) Floyd by Kvadrat
- (2B) Hideaway
- (S4) Kaleidoscope

#### Grade C

- (6K) Dots
- (68) Maya II
- (5E) Moondance
- (4T) Oceanic
- (3S) Scapes

#### Grade D

- (LW) Atlas by Kvadrat
- (4D) Big Arrow
- (1K) Big Diagonale
- (NV) Clara 2 by Kvadrat
- (66) Class II
- (JB) Cotswold
- (6M) Main Line Flax
- (S7) Melange Nap by Kvadrat
- (RP) Recheck by Kvadrat

#### Grade E

- (SY) Steelcut Trio by Kvadrat

#### Grade F

- (SV) Divina Melange 3 by Kvadrat
- (SZ) Hallingdal 65 by Kvadrat

### Screen Fabrics

#### Grade A

- (36) Aerial
- (6X) Chevron
- (35) Etch
- (L6) Highlands
- (C1) Striae
- (PY) Tailored
- (3A) Tellure

#### Grade B

- (4HV) Blanket
- (33) Camp
- (L5) Classic
- (34) Fields
- (3JV) Hobson
- (6) Hue
- (S4V) Kaleidoscope
- (ZR) Kio
- (2AV) Pixel
- (WS) Shimmer

#### Grade C

- (4EV) English Tweed
- (SW) Sisal

#### Grade D

- (4NV) Diagonale
- (4ZV) Element
- (67V) King II

#### Grade E

- (LWV) Atlas by Kvadrat
- (NVV) Clara 2 by Kvadrat
- (6SV) Floyd by Kvadrat
- (68V) Maya II

#### Grade G

- (66V) Class II
- (JBV) Cotswold
- (4TV) Oceanic

#### Grade H

- (S7V) Melange Nap by Kvadrat

\* For most current finish and fabric availability please reference [surfaces.haworth.com](https://surfaces.haworth.com).

## Haworth+

For information on the Haworth+ alliance program, including images and product availability, please refer to: [Haworth.com](https://Haworth.com) > Surface Collection > Haworth+ Library

## Customer's Own Material (COM)

For general Customer's Own Material (COM) information including processes and forms, please refer to: [Haworth.com](https://Haworth.com) > Surface Collection > Resources > COM

For information on approved COM's, please refer to: [Haworth.com](https://Haworth.com) > Surface Collection > COM Library

# Moxie — Modular Lounge

## COM Yardage Requirements

### Seating

Product	Width/Size	COM Yardage			
		Seat	Mid-Back	High-Back	Arm*
Straight Lounge	24"(610mm)	1.3	1.5	2.0	4.0
	30"(762mm)	2.1	1.8	2.6	4.0
	36"(914mm)	2.2	2.1	2.6	4.0
	42"(1067mm)	2.5	2.2	2.6	4.0
	48"(1219mm)	2.5	2.2	2.6	4.0
	54"(1372mm)	3.5	3.0	5.0	4.0
	60"(1524mm)	3.6	3.8	5.0	4.0
	66"(1676mm)	3.7	3.1	5.0	4.0
	72"(1829mm)	3.7	3.1	5.2	4.0
Curved Lounge - Concave	48"(1219mm)	3.0	3.3	5.0	N/A
	60"(1524mm)	3.1	4.5	5.5	N/A
Curved Lounge - Convex	48"(1219mm)	2.7	2.2	3.0	N/A
	60"(1524mm)	3.5	2.5	3.5	N/A
Square Corner Lounge	28"(711mm)	2.0	2.3	3.5	N/A
Half-Round	57"(1448mm)	2.5	1.0	N/A	N/A
	68"(1727mm)	3.2	1.5	N/A	N/A

### Straight Screens

Product	Width/Size	COM Yardage		
		No Arms	One Arm	Two Arms
Straight - No Return	24"(610mm)	1.8	1.8	1.8
	30"(762mm)	2.0	2.2	2.4
	36"(914mm)	2.4	2.6	2.6
	42"(1067mm)	2.8	2.8	3.0
	48"(1219mm)	3.0	3.2	3.4
	54"(1372mm)	3.4	3.6	3.6
	60"(1524mm)	4.0	4.0	4.0
	66"(1676mm)	4.0	4.2	4.2
	72"(1829mm)	4.4	4.6	4.6
Straight - One Return	24"(610mm)	N/A	3.0	3.0
	30"(762mm)	N/A	3.4	3.4
	36"(914mm)	N/A	3.4	3.4
	42"(1067mm)	N/A	3.6	4.0
	48"(1219mm)	N/A	4.0	4.0
	54"(1372mm)	N/A	4.4	4.4
	60"(1524mm)	N/A	4.6	4.8
	66"(1676mm)	N/A	5.0	5.2
	72"(1829mm)	N/A	5.4	5.4
Straight - Two Returns	24"(610mm)	N/A	N/A	4.0
	30"(762mm)	N/A	N/A	4.2
	36"(914mm)	N/A	N/A	4.6
	42"(1067mm)	N/A	N/A	4.8
	48"(1219mm)	N/A	N/A	5.2
	54"(1372mm)	N/A	N/A	5.6
	60"(1524mm)	N/A	N/A	5.8
	66"(1676mm)	N/A	N/A	6.2
	72"(1829mm)	N/A	N/A	6.6

# Moxie — Modular Lounge

## COM Yardage Requirements

### Curved Screens

Product	Width/Size	COM Yardage
Concave	48"(1219mm)	3.0
	60"(1524mm)	4.5
Convex	48"(1219mm)	3.0
	60"(1524mm)	4.0

### Square Corner Screens

Product	Width/Size	COM Yardage	
		One Side	Both Sides
Square Corner	28"(711mm)	2.0	4.0

### Intermediate Arm

Product	COM Yardage
Intermediate Arm	2.5

\*yardage noted is for one arm.

# Index

Products are listed alphabetically in this index by alpha-numeric prefix/suffix codes.

<b>Product Code</b>	<b>Product Description</b>	<b>Page</b>
EUSM-HFOW-1100	Power Module — Hardwire . . . . .	45
EUSM-HFOW-2100	Power Module — Hardwire . . . . .	45
EUSM-HLOW-1100	Power Module — Hardwire . . . . .	45
EUSM-HLOW-2100	Power Module — Hardwire . . . . .	45
EUSM-PFOW-2100	Power Module — Corded . . . . .	45
EUSM-PLow-2100	Power Module — Corded . . . . .	45
SXAA	Intermediate Arm . . . . .	36
SXCH-A	Curved Lounge . . . . .	28
SXCH-S	Curved Lounge . . . . .	27
SXCM-A	Curved Lounge . . . . .	27
SXCM-S	Curved Lounge . . . . .	27
SXCN-A	Curved Lounge . . . . .	26
SXCN-S	Curved Lounge . . . . .	26
SXCS	Curved Screen . . . . .	39
SXDT-S	Round Table . . . . .	44
SXG-10	Screen Alignment Clip . . . . .	40
SXH-ANN	Square Corner Lounge . . . . .	33
SXHM-ANN	Half-Round Lounge . . . . .	36
SXHM-SNN	Half-Round Lounge . . . . .	35
SXHN-ANN	Half-Round Lounge . . . . .	35
SXHN-SNN	Half-Round Lounge . . . . .	34
SXH-SNN	Square Corner Lounge . . . . .	32
SXM-ANN	Square Corner Lounge . . . . .	32
SXM-SNN	Square Corner Lounge . . . . .	32
SXN-ANN	Square Corner Lounge . . . . .	31
SXN-SNN	Square Corner Lounge . . . . .	31
SXOT	Intermediate Tablet . . . . .	37
SXQS	Square Corner Screen . . . . .	40
SXQT-A	Square Corner Table . . . . .	43
SXQT-S	Square Corner Table . . . . .	43
SXRT	Intermediate Tablet . . . . .	37
SXRT-A	Rectangle Table . . . . .	42
SXRT-S	Rectangle Table . . . . .	41
SXSH-ALN	Straight Lounge . . . . .	24
SXSH-ANN	Straight Lounge . . . . .	22
SXSH-SBN	Straight Lounge . . . . .	25
SXSH-SLN	Straight Lounge . . . . .	23
SXSH-SNN	Straight Lounge . . . . .	21
SXSM-ALN	Straight Lounge . . . . .	19
SXSM-ANN	Straight Lounge . . . . .	17
SXSM-SBN	Straight Lounge . . . . .	20
SXSM-SLN	Straight Lounge . . . . .	18
SXSM-SNN	Straight Lounge . . . . .	16
SXSM-SRN	Straight Lounge . . . . .	18
SXSN-ANN	Straight Lounge . . . . .	16
SXSN-SNN	Straight Lounge . . . . .	15
SXSS-M	Straight Screen with Return . . . . .	39
SXSS-M	Straight Screen . . . . .	38
SXVH-A	Curved Lounge . . . . .	30
SXVH-S	Curved Lounge . . . . .	29
SXVM-A	Curved Lounge . . . . .	29

# Index

---

<b><u>Product Code</u></b>	<b><u>Product Description</u></b>	<b><u>Page</u></b>
SXVM-S	Curved Lounge .....	.29
SXVN-A	Curved Lounge .....	.28
SXVN-S	Curved Lounge .....	.28
SXVS	Curved Screen .....	.39
USM-PFOW-1100	Power Module — Corded .....	.45
USM-PL0W-1100	Power Module — Corded .....	.45

# Product Compatibility and Limited Warranty Policy

## Great Expectations

You have them as a Haworth customer and so do we. And because we value our customers, we cover our products with the Haworth North America Product Compatibility and Limited Warranty Policy.

## Our Commitment To Product Compatibility – Integrated Product Platforms

As a market leader in the design and manufacture of workspaces that adapt to change, we strive to maintain product compatibility within our various generations of integrated product platforms. This benefits the customer who desires to update or modify their work environment. It also benefits the customer needing to replace a product due to damage or other reasons but which is no longer manufactured or is otherwise unavailable, such as a fabric or finish that is discontinued because of changing market preferences. In both circumstances, we often can provide products with comparable function and performance.

## Our Commitment To Product Quality – The Haworth North America Limited Warranty

To ensure customer satisfaction and peace of mind, we stand behind our products with the Haworth North America Limited Warranty. To review the current version of the limited warranty including its terms and conditions, please go to:

**[www.haworth.com/warranty](http://www.haworth.com/warranty) or contact [OneTouch@Haworth.com](mailto:OneTouch@Haworth.com) or 1 877 429 6784.**

## Warranty Requests or Questions

For questions or service requests pertaining to the Haworth Limited Warranty, please contact your Haworth dealer.

If you are unsure who your dealer is, please contact **[OneTouch@Haworth.com](mailto:OneTouch@Haworth.com) or 1 877 429 6784.**

# Terms of Sale

The Terms of Sale apply to all products in the North America Price Lists. To review the current version of the North American Terms of Sale, please go to:

**[www.haworth.com/terms-of-sale](http://www.haworth.com/terms-of-sale) or contact [OneTouch@Haworth.com](mailto:OneTouch@Haworth.com) or 1 877 429 6784.**

HAWORTH® is a registered trademark of Haworth, Inc.

© Haworth, Inc. All rights reserved. 2026 7.26

[haworth.com](http://haworth.com) | 800 344 2600