

TECHNICAL SPECIFICATION

hushfree.L HUS-AP-003

THE BIGGEST ACOUSTIC BOOTH FOR COMFORTABLE MEETINGS FOR 4 TO 6 PEOPLE

HushFree.L is an A-rated acoustic booth with new 500 lux lighting. The booth is an ideal alternative to traditional meeting rooms. It is perfectly suited for larger business meetings, presentations, video conferences with bigger groups, team meetings – whether onsite or online. You can furnish the booth as you wish. Arrange its interior yourself or equip it with a ready-made table and sofas – two or four – and additional coffee tables.



DIMENSIONING



6

W/D/H: exterior 86.92 x 109.44 x 90.55 in
interior 78.48 x 106.29 x 80.07 in

Weight: 2092 lbs **Weight with box:** 2630 lbs

Logistic data is available on request.

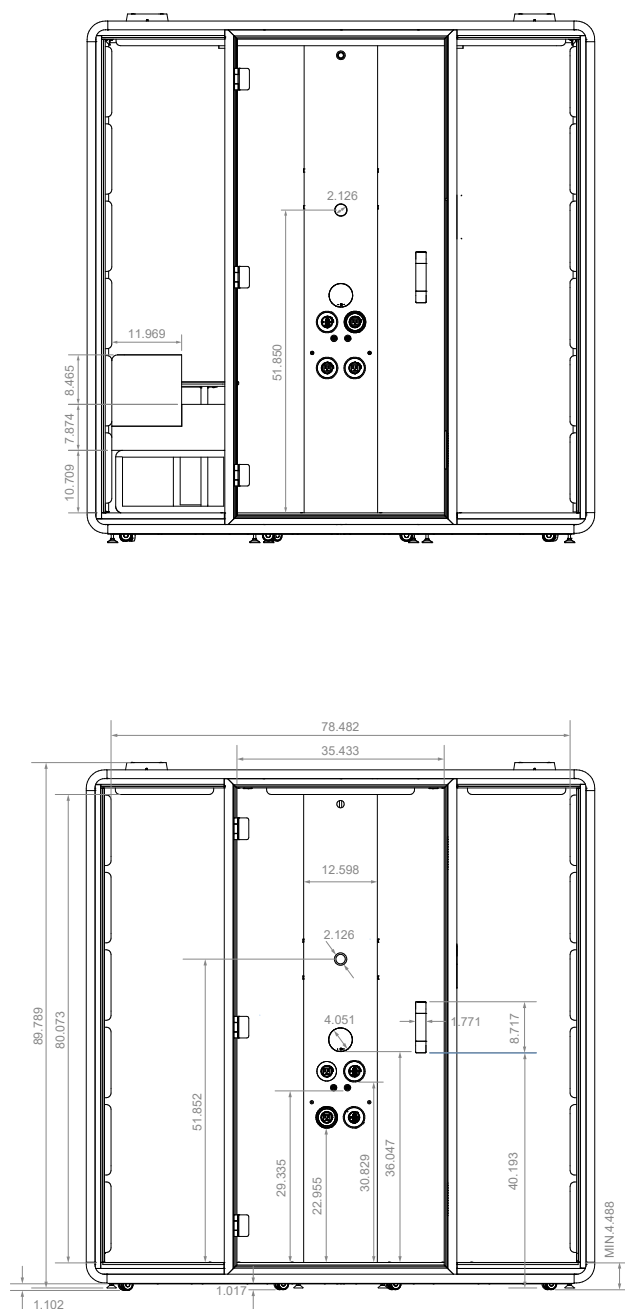
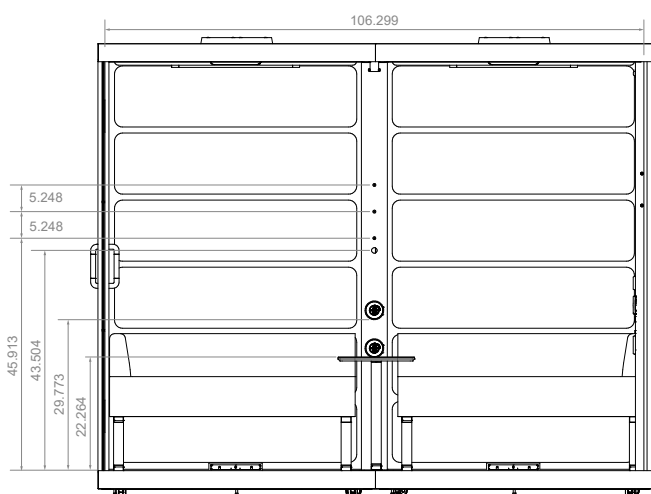
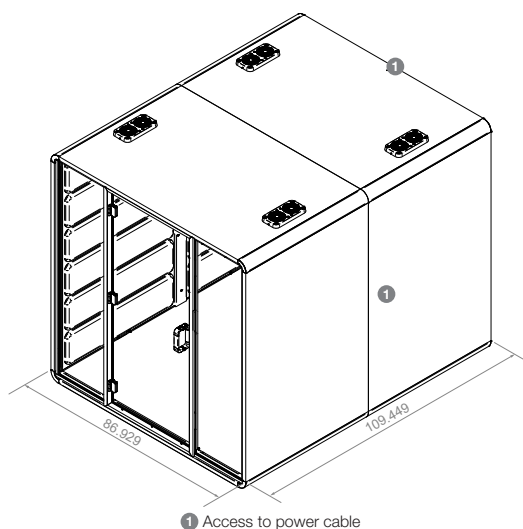

hushoffice

Manufacturer: Fabryka Mebli Biurowych Mikomax sp. z o.o. | 93-231 Łódź ul. Dostawcza 4, Polska
Distributor: Mikomax sp. z o.o. | 93-231 Łódź ul. Dostawcza 4, Polska

hushoffice.com

TECHNICAL SPECIFICATION

hushfree.L HUS-AP-003

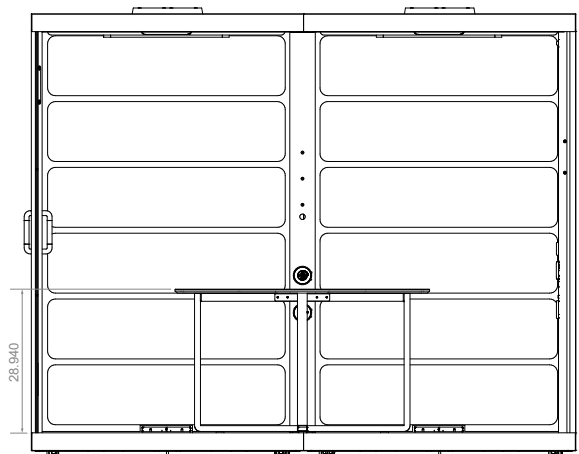
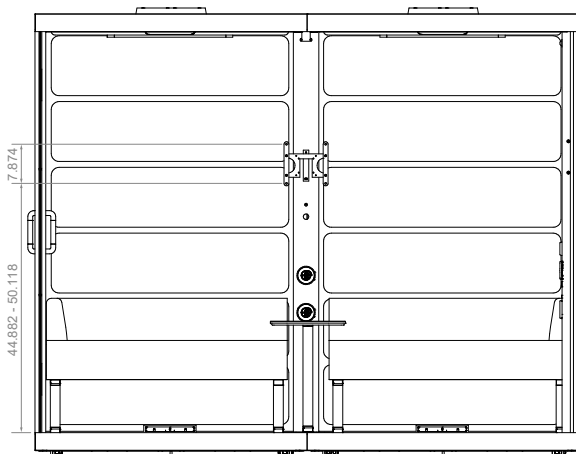
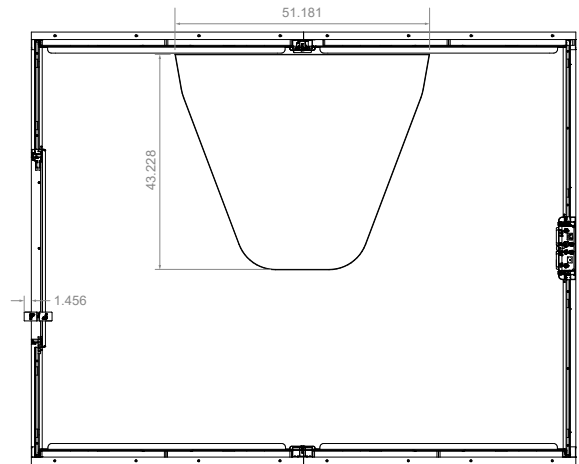
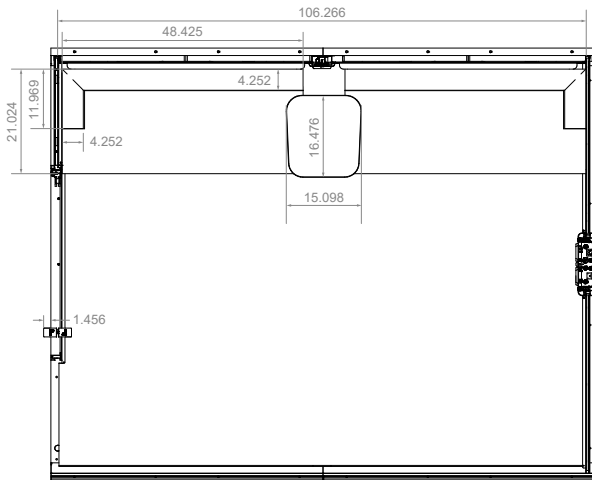

ELECTRIC SYSTEM

LED CEILING LIGHT x4.

POWER SUPPLY MODULE (BASIC): 2x power supply, 2x RJ45.

POWER SUPPLY MODULE (OPTIONAL, AS REQUIRED): 1x type A, 1x type C charger with a total power of 5.0 V/4.0 A MAX, HDMI.

POWER CABLE: Black cable with three-prong grounded plug 110V. The product can be powered from the top or bottom (detailed information can be found in the Assembly Manual). For the power supply from the top 2.36 in milling for the power cable outlet prepared from the inside of the ceiling (not visible from outside). The total length of the cable – 16.40 ft. The cable length for the exit of unit – 11.15 ft.

LAN PLUG CAT.6: available with 16.40 ft total cable length, and available with 11.15 ft at the booth exit.

The exact dimensions for the location of the power cable outlet and the LAN CAT.6 are available on request.

MOTION SENSOR: located on the central column, activates lighting at 50% and ventilation systems at 100% of total power. Standby power consumption 5 W.

Maximum power consumption of the product 125 W.

TECHNICAL SPECIFICATION

hushfree.L HUS-AP-003



LIGHTING

LED ceiling light x4, 30 W / 4000 K, lm – 2300; lux – min. 300 / medium 500 / max. 700. Adjusted in the range of 2200 - 6500K.



VENTILATION SYSTEM

8 fans x 80 m³/h with a maximum airflow 329 CFM. Total air exchange 210 seconds, 178 l/s.

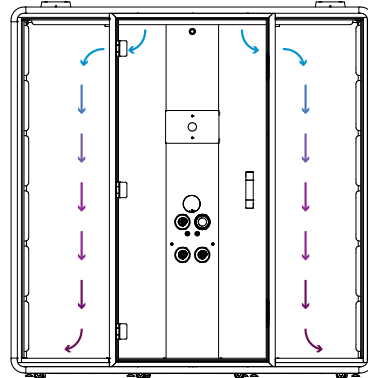

EXTERIOR

GLASS DOOR WITH HANDLE: acoustic, tempered and laminated safety glass 0.39 in, 5.5.2 thickness, including the 0.19 in glass, 0.07 in acoustic sheet and 0.19 in glass. Anti-collision marking – silkscreen integrated inside the 2.55 in wide glass. Transparent glass. Left or Right-handed door – option to be chosen at the installation stage. Doors with magnetic closure and the possibility of adjusting the tightening force.

REAR SIDE GLASS PANELS: acoustic and laminated glass 0.39 in (RW= 35 dB), 5.5.2 thickness, including the 0.19 in glass, 0.07 in acoustic sheet and 0.19 in glass. Placed in aluminum profiles with acoustic seal. Transparent glass. Frosted version as an option.

DOOR HANDLE AND HINGES: painted in cosmos grey. Handle dimensions: 1.77 x 8.70 in.

CASE: 3-layer honeycomb board with a thickness of 1.49 in. Both sides covered with melamine and finished with ABS edging. Structure prepared for anti-seismic ground fixing.

16 integrated castors with levelling feet.



INTERIOR

INTEGRAL CARPETED FLOOR: complies with ASTM D2859 – 16 (2021), standard test method for ignitability characteristics of ready to use textile floor covering materials. Adapted to commercial intensive use (hotel room, hotel suite, boutique, shop, restaurant, conference room, high traffic office, reception, stairs). Graphite color.

PANEL WITH CEILING LIGHT: in cosmos grey. Total dimensions 7.48 x 25.19 in, ceiling light dimensions: 2.75 x 25.19 in, hole prepared for smoke detector diameter 0.78 in, hole prepared for sprinkler installation diameter 2.55 in.

ELECTRICAL PLUGS DIAMETER: 3.70 in.

INTERIOR PANELS: Made as a composite based on PETFELT, polyester fleeces and fabric. PUR fire-retardant foam with acoustic properties, re-bonded.

HUSHASSISTANT: 4-inch, round, high-resolution touchscreen to control pod settings, adjust lighting and airflow, and extend calendar reservations. Hush-Assistant can adjust brightness, color and activate scenes (moods) for different needs. Prepared for integration into the product's power supply. The system supports integration with the Microsoft 365 platform.

PANELS UPHOLSTERY Athlon Plus:

weight: 750 g/lm – 24.19 oz/in.yd; **composition:** 56% polyester, 44% Trevira CS; **flammability:** cigarette (BS EN 1021-1), cigarettes and matches (BS EN 1021 1&2), CA TB 117-2013; **light fastness:** 5 (EN ISO 105B02); **pilling resistance:** 5 (EN ISO 12945-2); **abrasion resistance:** 100.000 martindale cycles (EN ISO 12947-2); **certification:** OEKO-TEX® STANDARD 100.

SOFAS UPHOLSTERY Athlon:

weight: 750 g/lm – 24.19 oz/in.yd; **composition:** 100% polyester; **flammability:** cigarette (BS EN 1021-1), CA TB 117-2013; **light fastness:** 5 (EN ISO 105B02); **pilling resistance:** 5 (EN ISO 12945-2); **abrasion resistance:** 100.000 martindale cycles (EN ISO 12947-2); **certification:** OEKO-TEX® STANDARD 100.X®.

HUSHCONFERENCETABLE.L (optional): measuring W/D/H 51.18 x 43.22 x 28.93 in. Made of 0.70 in thick plywood covered with HPL laminate on both sides. Support leg made of 1.18 x 1.96 in steel profile, powder-coated in cosmos grey colour. Maximum load – **33 lbs.**

HUSHCOFFEETABLE.L (optional) measuring W/D/H 15.09 x 16.47 x 22.26 in. Made of 0.7 inch thick plywood, covered with HPL laminate on both sides. Available in two finishes: white and black velvet colours. Supporting leg made of 1.18 x 1.96 in steel profile, powder-coated in cosmos grey colour. Maximum load – **22 lbs.**

HUSHOCCUPANCY.SIGN (optional): booth occupancy light indicator, measuring 3.77 x 3.77 x 1.49 in, prepared to be integrated with the ventilation module power supply. Adapted to be positioned on the booth ceiling anywhere within 39.37 in of the fan housing. Actuated by a motion sensor.

SET OF DOUBLE SOFAS (optional): seat module including backrest, available in left and right versions of 48.42 x 21.02 x 27.08 in overall dimensions. Seat height – 18.62 in, backrest height from seat – 8.46 in. Inner structure made of wood-based materials, sprung layer – 100% PU foam, fluffy fleece 100% Polyester. Outer layer – upholstery fabric. Maximum load of the sofa – **485 lbs.**

HUSHSCREEN.SET (optional): adapter for mounting a TV monitor with VESA bracket (in) 2.95 x 2.95; 3.93 x 3.93; 3.93 x 7.87; 7.87 x 3.93; 7.87 x 7.87 with overall dimensions 8.70 x 8.89 x 1.77 in. Adapted for mounting on the centre column of the booth by means of mounting screws which are an integral part of the column. Structure made of bent sheet metal powder-coated in cosmos grey colour.

HUSHSCREEN.BRACKET (optional): VESA bracket (in) 2.95 x 2.95; 3.93 x 3.93; 3.93 x 7.87; 7.87 x 3.93; 7.87 x 7.87. Adapted for mounting on the side column of the booth by means of mounting screws which are an integral part of the column.



hushoffice

Manufacturer: Fabryka Mebli Biurowych Mikomax sp. z o.o. | 93-231 Łódź ul. Dostawcza 4, Polska
Distributor: Mikomax sp. z o.o. | 93-231 Łódź ul. Dostawcza 4, Polska

hushoffice.com

TECHNICAL SPECIFICATION

hushfree.L HUS-AP-003

OPTIONAL EQUIPMENT	WEIGHT:	WEIGHT WITH BOX:
HUSHSOFA.MEDIUM.RH /LH (1 PC.)	45.41 lbs	54.23 lbs
HUSHCOFFEETABLE.L (1 PC.)	4.40 lbs	5.07 lbs
HUSHCONFERENCETABLE.L	36.37 lbs	38.58 lbs
HUSHSCREEN.SET	5.07 lbs	5.29 lbs
HUSHSCREEN.BRACKET	2.42 lbs	3.30 lbs

ACOUSTIC RATING

Frequency range 125 Hz to 8000 Hz according to ISO 23351-1:2020. Speech level reduction – D_{sA} 30,2 dB.

SEISMIC ANCHORAGE

Product with Seismic Anchoring capability as standard solution. Instructions on how to anchor are available on request.

SUSTAINABLE DEVELOPMENT

Hushoffice booths are manufactured in the ISO 9001 and 14001 certified production factory in Poland by Mikomax Smart Office. The production process complies with the ISO 14001 environmental management system standard. Hushoffice booths are packaged and delivered in lightweight, recyclable cardboard boxes.

CERTIFICATION



warranty



Made in EU



PEFC/04-04-0007
DINC-PEFC-COC-001290



hushoffice

Manufacturer: Fabryka Mebli Biurowych Mikomax sp. z o.o. | 93-231 Łódź ul. Dostawcza 4, Polska
Distributor: Mikomax sp. z o.o. | 93-231 Łódź ul. Dostawcza 4, Polska

hushoffice.com