

TECHNICAL SPECIFICATION

hushfree.L HUS-AP-003

THE BIGGEST ACOUSTIC BOOTH FOR COMFORTABLE MEETINGS FOR 4 TO 6 PEOPLE

HushFree.L is an A-rated acoustic booth with new 500 lux lighting. The booth is an ideal alternative to traditional meeting rooms. It is perfectly suited for larger business meetings, presentations, video conferences with bigger groups, team meetings – whether onsite or online. You can furnish the booth as you wish. Arrange its interior yourself or equip it with a ready-made table and sofas – two or four – and additional coffee tables.



DIMENSIONING



6

W/D/H: exterior 2210 x 2780 x 2300 mm
interior 1993 x 2699 x 2034 mm

Weight: 949 kg **Weight with box:** 1193 kg

Logistic data is available on request.

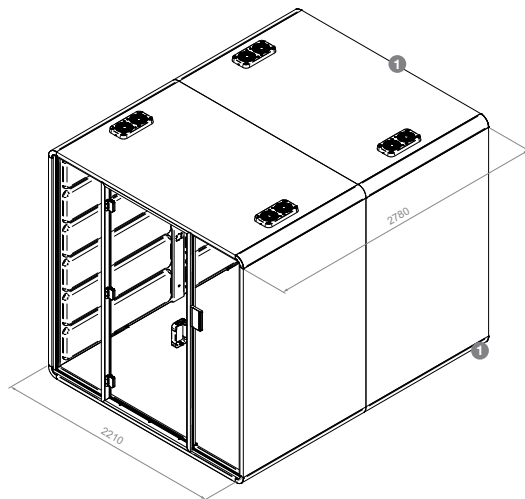

1 Access to power cable

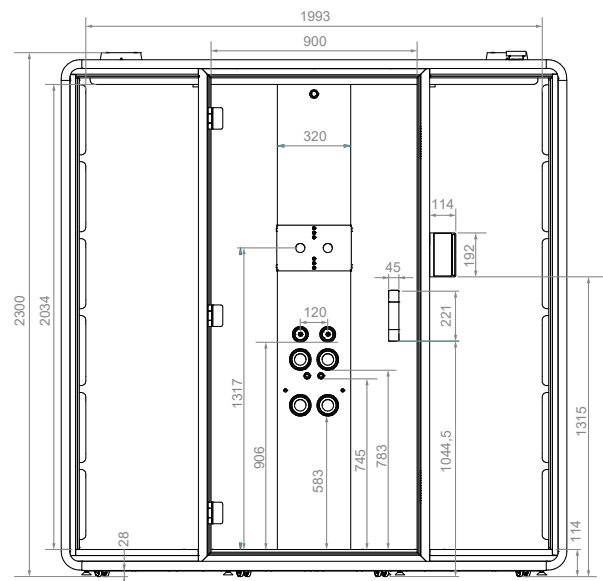
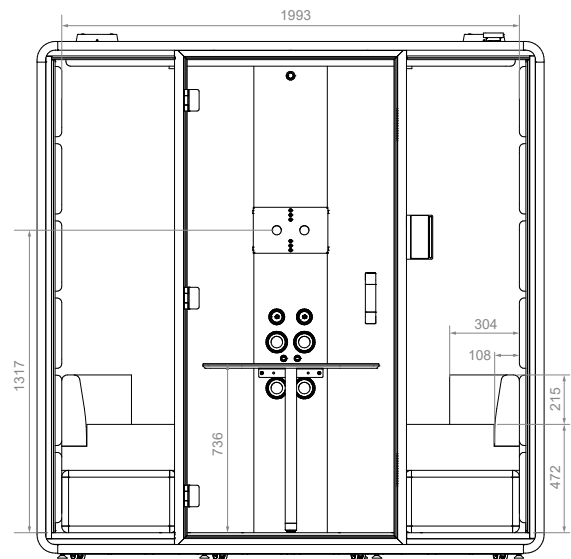
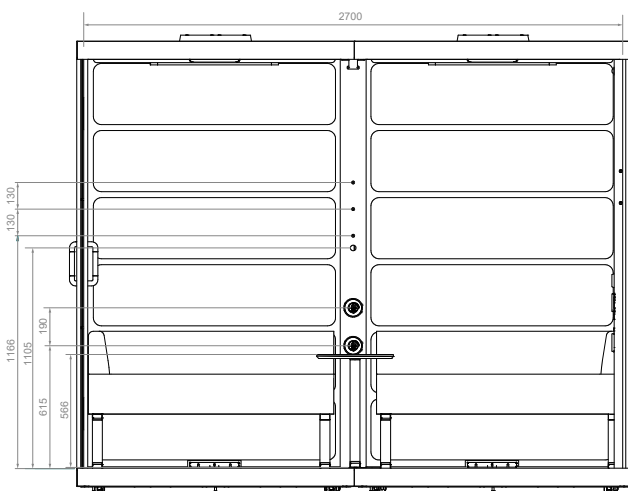

hushoffice

Producent: Fabryka Mebli Biurowych Mikomax sp. z o.o. | 93-231 Łódź ul. Dostawcza 4, Polska
Dystrybutor: Mikomax sp. z o.o. | 93-231 Łódź ul. Dostawcza 4, Polska

hushoffice.com

TECHNICAL SPECIFICATION

hushfree.L HUS-AP-003

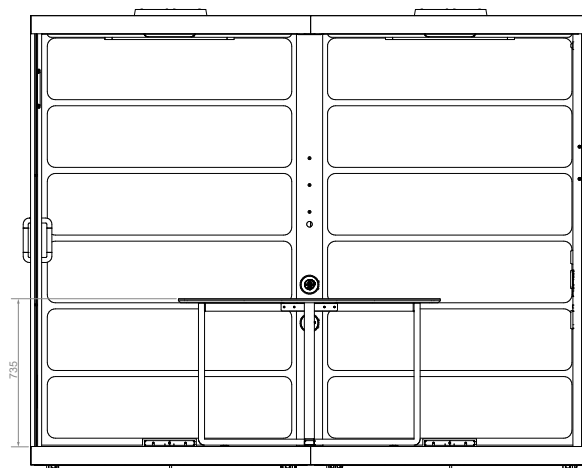
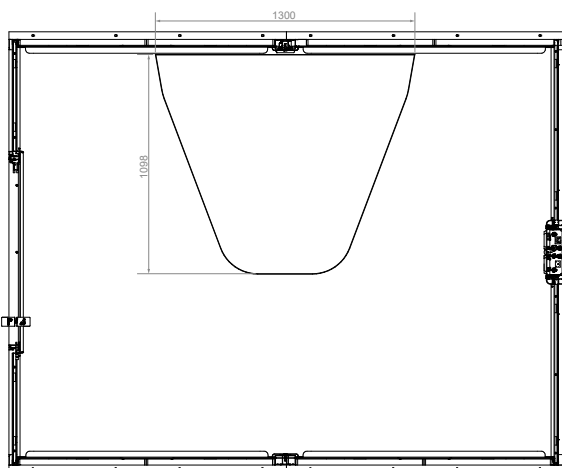
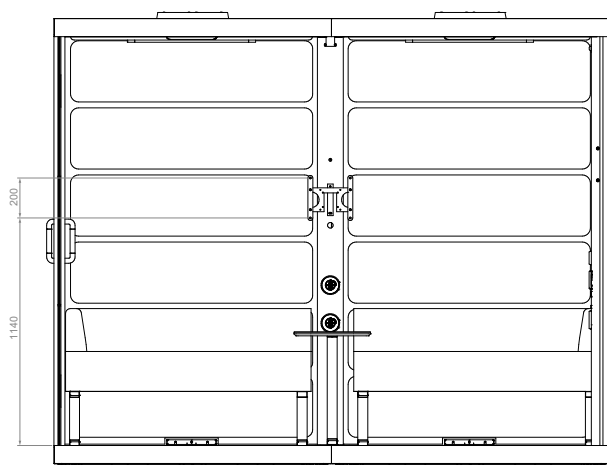
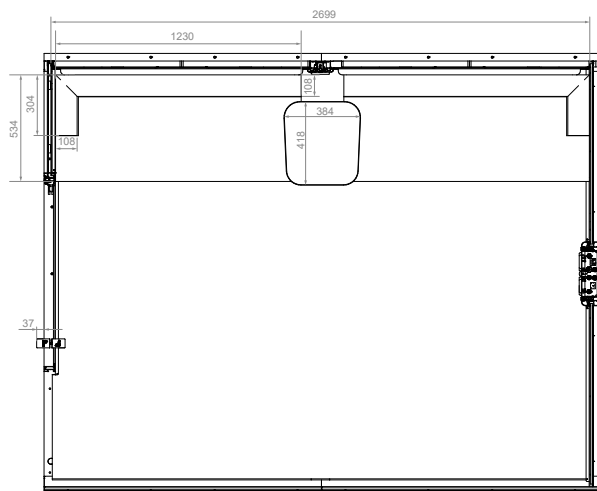

LIGHTING

LED ceiling light x4, 30 W / 4000 K, lm – 2300; lux – min. 300 / medium 500 / max. 700.

ELECTRIC SYSTEM

LED CEILING LIGHT x4.

POWER SUPPLY MODULE (BASIC): 2x power supply 230V, 2x RJ45.

POWER SUPPLY MODULE (OPTIONAL, AS REQUIRED): type A charger, 1x type C charger with a total power of 5.0 V/4.0 A MAX, HDMI.

POWER CABLE: black – access from the floor with 5000 mm overall length. Access from the booth exit, 3400 mm.

LAN PLUG CAT.6: available with 5000 mm total cable length, and available with 3400 mm at the booth exit.

MOTION SENSOR: located in the ceiling, activates lighting and ventilation systems at 50% of total power. Standby power consumption 5W.

Maximum power consumption of the product 125 W.

VENTILATION SYSTEM

8 fans x 80 m³/h / 59 seconds.

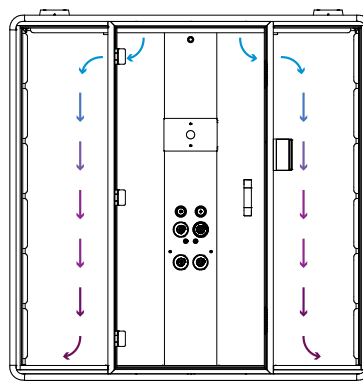

hushoffice

Producent: Fabryka Mebli Biurowych Mikomax sp. z o.o. | 93-231 Łódź ul. Dostawcza 4, Polska
Dystrybutor: Mikomax sp. z o.o. | 93-231 Łódź ul. Dostawcza 4, Polska

hushoffice.com

TECHNICAL SPECIFICATION

hushfree.L HUS-AP-003

EXTERIOR

GLASS DOOR WITH LATCH HANDLE: acoustic, tempered and laminated safety glass 10 mm, 5.5.2 thickness, including the 5 mm glass, 2 mm acoustic sheet and 5 mm glass. Anti-collision marking – silkscreen integrated inside the 65 mm wide glass. Transparent glass.

REAR SIDE GLASS PANELS: acoustic and laminated glass 10 mm (RW= 35 dB), 5.5.2 thickness, including the 5 mm glass, 2 mm acoustic sheet and 5 mm glass. Placed in aluminum profiles with acoustic seal. Transparent glass. Matte version as an option.

DOOR HANDLE AND HINGES: painted in cosmos grey. Handle dimensions: 45 x 221 mm.

CASE: 3-layer honeycomb board with a thickness of 38 mm. Both sides covered with melamine and finished with ABS edging. Structure prepared for anti-seismic ground fixing.

16 integrated castors with levelling feet.

INTERIOR

INTEGRAL CARPETED FLOOR: complies with ASTM D2859 – 16 (2021), standard test method for ignitability characteristics of ready to use textile floor covering materials. Adapted to commercial intensive use (hotel room, hotel suite, boutique, shop, restaurant, conference room, high traffic office, reception, stairs). Graphite color.

PANEL WITH CEILING LIGHT: in cosmos grey. Total dimensions 190 x 640 mm, ceiling light dimensions: 70 x 640 mm, hole prepared for smoke detector diameter 20 mm, hole prepared for sprinkler installation diameter 65 mm.

KNOBS AND ELECTRICAL PLUGS DIAMETER:
Knob – 69 mm. Plug – 94 mm.

INTERIOR PANELS: Made as a composite based on PETFELT, polyester fleece and fabric. PUR fire-retardant foam with acoustic properties, re-bonded.

UPHOLSTERY Athlon Plus:

weight: 750 g/m²; **composition:** 56% polyester, 44% Trevira CS; **flammability:** cigarette (BS EN 1021-1), cigarettes and matches (BS EN 1021 1&2), CA TB 117-2013; **light fastness:** 5 (EN ISO 105B02); **pilling resistance:** 5 (EN ISO 12945-2); **abrasion resistance:** 100.000 martindale cycles (EN ISO 12947-2); **certification:** OEKO-TEX® STANDARD 100.

TABLE (optional): measuring W/D/H 1300 x 1098 x 735 mm. Made of 18 mm thick plywood covered with HPL laminate on both sides. Support leg made of 40 x 50 mm steel profile, powder-coated in cosmos grey colour. Maximum load – **15 kg**.

BOOTH OCCUPANCY INDICATOR (optional): booth occupancy light indicator, measuring 86 x 86 x 37 mm, prepared to be integrated with the ventilation module power supply. Adapted to be positioned on the booth ceiling anywhere within 1000 mm of the fan housing. Actuated by a motion sensor.

RESERVATION MODULE* (optional): measuring 114 x 22.5 x 192 mm. Luminous side panel and touchscreen display indicating booth occupancy, enabling reservations, prepared to be integrated with the booth's power supply. The system can be integrated with the Microsoft 365 platform.

* Option available from Q2 2024.

SET OF SOFAS (optional): seat module including backrest, available in left and right versions of 1230 x 534 x 688 mm overall dimensions. Seat height – 473 mm, backrest height from seat – 215 mm. Inner structure made of wood-based materials, sprung layer – 100% PU foam, fluffy fleece 100% Polyester. Outer layer – upholstery fabric. Maximum load of the sofa - 220 kg.

TV MOUNTING KIT (optional): adapter for mounting a TV monitor with VESA bracket (mm) 75 x 75; 100 x 100; 100 x 200; 200 x 100; 200 x 200 with overall dimensions 221 x 226 x 45 mm. Adapted for mounting on the centre column of the booth by means of mounting screws which are an integral part of the column. Structure made of bent sheet metal powder-coated in cosmos grey colour.

OPTIONAL EQUIPMENT	WEIGHT:	WEIGHT WITH BOX:
SOFA (1 PC.)	20,6 kg	24,6 kg
1 COFFIE TABLE	2 kg	2,3 kg
TABLE HUSHFREE.L	16,5 kg	17,5 kg
TV MOUNT SET	2,3 kg	2,4 kg
VESA	1,1 kg	1,5 kg

ACOUSTIC RATING

Acoustic measurements according to ISO 23351-1:2020 – class A.

TECHNICAL SPECIFICATION

hushfree.L HUS-AP-003



SUSTAINABLE DEVELOPMENT

Hushoffice booths are manufactured in the ISO 9001 and 14001 certified production factory in Poland by Mikomax Smart Office. The production process complies with the ISO 14001 environmental management system standard. Hushoffice booths are packaged and delivered in lightweight, recyclable cardboard boxes.



CERTIFICATION



Warranty



Made in EU



PEFC/04-04-0007
DINC-PEFC-COC-001290



hushoffice

Producent: Fabryka Mebli Biurowych Mikomax sp. z o.o. | 93-231 Łódź ul. Dostawcza 4, Polska
Dystrybutor: Mikomax sp. z o.o. | 93-231 Łódź ul. Dostawcza 4, Polska



hushoffice.com