



# BuzziBlox

Design by BuzziSpace Studio

En alternant les épaisseurs, l'absorption des différentes longueurs d'onde dans les épaisses couches de mousse sera améliorée et la réflexion des ondes dans la pièce sera contenue. Cet effet de diffusion donnera à la pièce une expérience sonore plus agréable.

HAWORTH® Collection

# BuzziBlox

Design by BuzziSpace Studio



## DIMENSIONS

### BuzziBlox Square

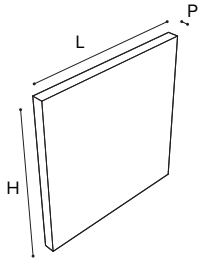

**SQ-4**  
L 595mm H 595mm P 40mm

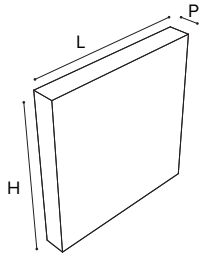

**SQ-8**  
L 595mm H 595mm P 80mm

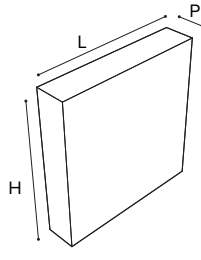

**SQ-12**  
L 595mm H 595mm P 120mm

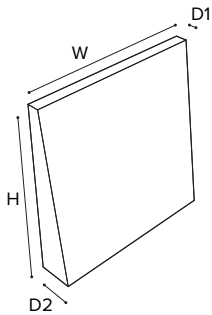

**SQ-Wedge**  
L 595mm H 595mm P1 40mm P2 120mm

### BuzziBlox Rectangular

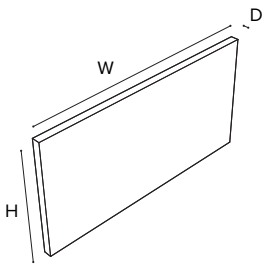

**R-4**  
L 1190mm H 595mm P 40mm

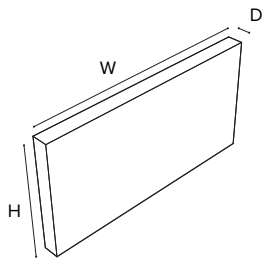

**R-8**  
L 1190mm H 595mm P 80mm

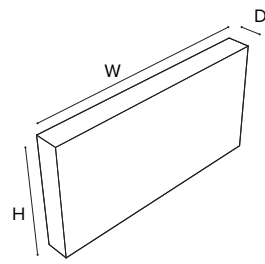

**R-12**  
L 1190mm H 595mm P 120mm

**RXL-8**  
L 2000mm H 1000mm P 80mm

**RXL-12**  
L 2000mm H 1000mm P 120mm

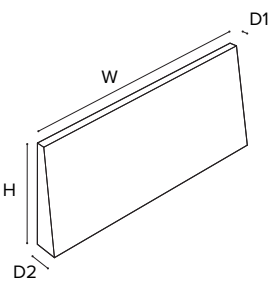

**R-Woss**  
L 1190mm H 595mm P1 40mm P2 120mm

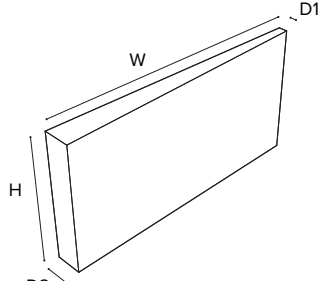

**R-Woss**  
L 1190mm H 595mm P1 40mm P2 120mm

## MATÉRIAUX

Référez-vous au tarif BuzziSpace pour connaître l'intégralité des finitions

### Tissu Groupe A

Tissu  
Kvadrat® Revive 1  
Kvadrat® Revive 2  
Rough  
Trevira CS  
Trevira CS+

### Tissu Groupe B

Kvadrat® Clara 2  
Kvadrat® Remix 2  
Terra

### Tissu Groupe C

Kvadrat® Hero

### Tissu Groupe D

Kvadrat® Tonus 4  
Kvadrat® Tonus Meadow

### Tissu Groupe E

Kvadrat® Memory 2

### Tissu Groupe F

Kvadrat® Matrix

## ACOUSTIQUES

PRINCIPES ACOUSTIQUES



Absorption



Diffusion

## SYSTÈMES DE FIXATION

### Fixation au mur (inclus)

### Fixation au plafond (en option)

Fixing System Screw  
Fixing System Magnet

Pour connaître l'intégralité des systèmes de fixation, référez-vous au tarif Buzzispace..

HAWORTH® Collection

haworth.com/eu/collection

# BuzziBlox

Design by BuzziSpace Studio



## DIMENSIONS

### BuzziBlox Hexa

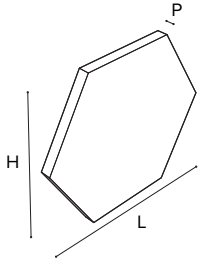

**Hexa-4**  
L 693mm H 600mm P 40mm

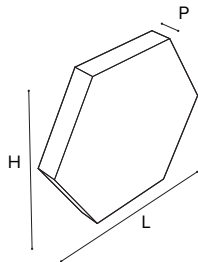

**Hexa-8**  
L 693mm H 600mm P 80mm

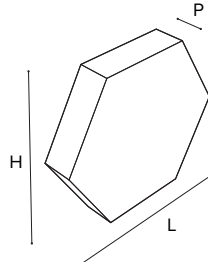

**Hexa-12**  
L 693mm H 600mm P 120mm

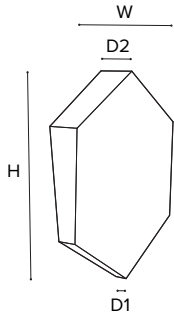

**Hexa-Wedge**  
L 693mm H 600mm P1 40mm P2 120mm

### BuzziBlox Penta

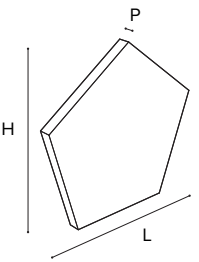

**Penta-4**  
L 631mm H 600mm P 40mm

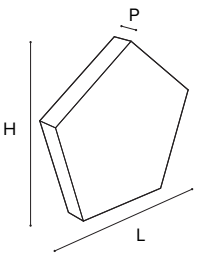

**Penta-8**  
L 631mm H 600mm P 80mm

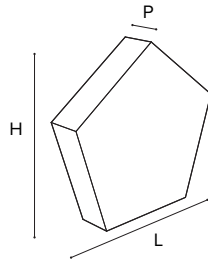

**Penta-12**  
L 631mm H 600mm P 120mm

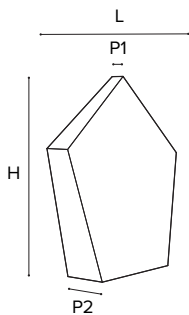

**Penta-Wedge**  
L 631mm H 600mm P1 40mm P2 120mm

HAWORTH® Collection

[haworth.com/eu/collection](http://haworth.com/eu/collection)

# BuzziBlox

Design by BuzziSpace Studio



## DIMENSIONS DES POINTS DE FIXATION (uniquement pour la suspension plafond)

### Square | Square Wedge

---

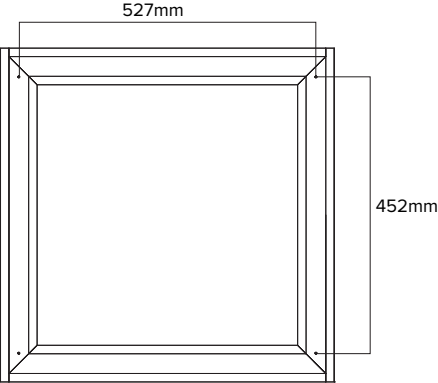

### Rectangular | Rectangular Wedge

---

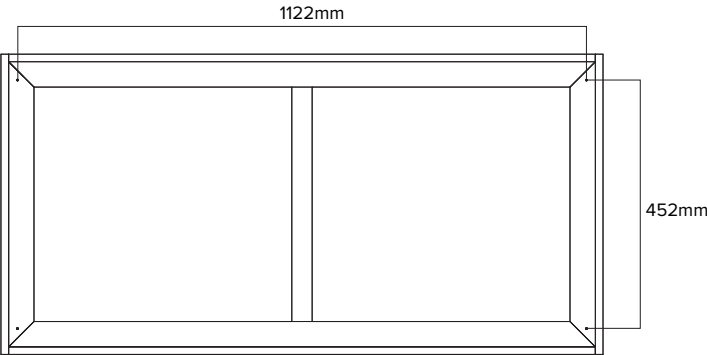

### Rectangular XL

---

