

casparline

COLLEZIONE
OUTDOOR
PROGETTO OGGETTO
FLEXI CONTAINER

EXPORT public price list - March 2024
prices in euro VAT not included

cappellini

collezione

outdoor

progetto oggetto

flexi container

EXPORT public price list - March 2024
prices in euro VAT not included

index

Sales condition	6
Fabrics for meter - Leather for square meter	7
Colours, Woods and Marbles	8
Collezione	11
cabinets and bookshelves	13
tables and service tables	39
sofas and armchairs	79
chairs, stools and armchairs	161
beds	211
complementary	223
Outdoor	231
tables and service tables	233
sofas and armchairs	241
chairs, stools and small armchairs	249
Progetto Oggetto	257
Lighting	257
Accessories	257
technical information	283
Flexi Container	307
Flexi Container	307

Sales conditions

ORDERS

Order confirmations

Eventual changes or cancellation on current orders must be notified within 5 (five) days from the receipt of the order confirmation. In this case no expenses will be charged. If the change or cancellation are notified after 5 days, their costs will be charged. A new delivery date will be communicated.

Precautions

Cap Design SpA has the right to suspend deliveries when the economic conditions of the Customer are considered risky. In case of deferred payment, a not honoured invoice gives Cap Design SpA the authority to require the immediate payment of the remaining amount.

Payments

Payments have to be made directly to us. Payments made by a third party will be accepted only when authorised in writing by us. Interest in 3 points more than the official interest rate will run on the unpaid invoices on maturity and a draft at sight will be issued for the due amount without duty of notice to the client.

Custom colours

For any request regarding special colours, if accepted by Cap Design SpA, there will be a surcharge of 25%.

Packaging

All our products are being packed and shipped in cardboard boxes. In addition, all delicate product categories will be automatically shipped in wooden crates. All standard packaging is included in the list price.

PRODUCTS

The firm has the right to make drawing and material changes to its own products without warning.

Guarantee

Cap Design SpA guarantees its products up to 2 years from delivery. The guarantee is valid exclusively for the use the product is intended to. Guarantee is declined automatically in case of misuse or improper use.

Claims

Every kind of claim will be accepted only within 8 (eight) days from the receipt of goods. Claims of evident and visible quality defects will be repaired or replaced only after approval by the manufacturer, maintaining the same good returns conditions as the original order.

Returns

Goods returns will be accepted only when authorised in writing by us and delivered in the original packing. Damages to the product caused by an inadequate packaging will authorise Cap Design SpA to charge the repairing costs to the Customer.

Tolerance

The colours of the full set of samples for lacquering, wood etc., are only indicative, being technically impossible to assure the firmness of colour at a long distance. The finishings in matt and polish lacquer can present different tonalities of colour depending on the lot of varnish. The finishings in wood can present different veins and colours lot to lot, and colours of the wood can change in time due to its natural maturity.

TRANSPORT

Upon receipt of the goods the Customer is in charge of counting the boxes and verifying their conditions. In case of damaged boxes or missing items please notify on transportation bill and send a written notice to Cap Design. Receiving such information after that term, Cap Design reserves the right to charge additional costs to the Customer.

Delivery terms

Delivery term stated on the order confirmation is approximate and no penalties or responsibilities due to delayed delivery will be accepted. Fixed delivery date must be agreed in advance with Cap Design SpA.

PRICE LIST VALIDITY

This price list cancels and replaces the previous one and can be changed without notice.

COMPETENT COURT

Any dispute between the parties shall be brought in front of the Foro of Milan.

FABRICS AND LEATHERS

The fabric and leather coverings can present some colour variations stock by stock, therefore we do not take the responsibility for possible colour differences.

The fabric requirements indicated in the price list are for plain colours fabric width 140 cm.

In case of order of products with coordinated fabrics of different categories, we will apply the price of the higher category.

C.O.M. Fabrics

In case of C.O.M. fabric or leather, the Customer has to send in advance a sample for approval.

Covering materials supplied by Customers must be delivered to us free of charge and under DDP term, otherwise the costs will be charged to the Customer.

For C.O.M. fabric please consider price in cat. A and for C.O.M. leather cat. B or the lowest category available for that product.

For fabric coverings supplied by customers, please point out front and back side, as well as top and bottom in case of printed material.

For fabrics with pattern repeat or with less than 140 cm. width, please contact Cap Design in advance.

			price
--	--	--	-------

Fabrics (for meter) - Leathers (for square meter)

fabric	A	65
fabric	B/P	85
fabric	C	105
fabric	D	155
fabric	E	220
fabric	E1	320
leather	G	165
extra leather	G2	200

Pre-washing (for meter)

Water-washable fabrics must be pre-washed before the covering.

MATT / POLISH LACQUERS

- 01 white
- 46 magnolia
- 59 beige
- 60 desert
- 07 light grey
- 48 anthracite
- 04 black

MATT EXTRA / POLISH EXTRA LACQUERS

- 71 mud
- 93 straw yellow
- 78 pumpkin
- 45 chestnut brown
- 47 fog
- 10 dark grey
- 95 powder pink
- 96 terracotta
- 53 orange
- 94 brick red
- 55 red
- 54 bordeaux
- 84 aquamarine
- 81 jade
- 92 sage green
- 18 powder green
- 56 dark green
- 76 english green
- 77 petrol blue
- 91 sky blue
- 11 cloud
- 80 lapis
- 44 china blue
- 49 india blue

WOODS

- 133 natural oak
- 158 black-stained oak

- 113 bleached ash
- 116 oak-stained ash
- 112 black-stained ash
- 118 blue shanghai aniline stained ash

MARBLES

- 521 white carrara marble
- 528 grey roma marble
- 523 black marquinia marble
- 527 light straw-yellow travertine
- 526 green alps marble

index

Collezione

cabinets and bookshelves	13
tables and service tables	39
sofas and armchairs	79
chairs, stools and armchairs	161
beds	211
complementary	223

cabinets and bookshelves

Aliante	<i>Giulio Cappellini, Rodolfo Dordoni</i>	14
Bookshelf	<i>Shiro Kuramata</i>	15
Cloud	<i>Ronan e Erwan Bouroullec</i>	16
Dinah	<i>Shiro Kuramata</i>	17
Drop	<i>Nendo</i>	18
Easy	<i>Studio Cappellini</i>	19
Homage to Mondrian	<i>Shiro Kuramata</i>	23
Lochness	<i>Piero Lissoni</i>	23
Luxor	<i>Giulio Cappellini</i>	26
Progetti Compiuti	<i>Shiro Kuramata</i>	30
Pyramid	<i>Shiro Kuramata</i>	32
Revolving Cabinet	<i>Shiro Kuramata</i>	33
Simplon	<i>Jasper Morrison</i>	34
Uni	<i>Piero Lissoni</i>	34

Series of wall-mounted bookshelves with metal structure and wooden shelves, veneered or lacquered in all the colours of the collection.

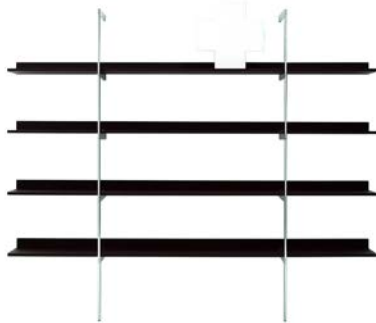

Structure

metal tube with rectangular section

Structure finish

407 chromed

matt varnished

01 white

04 black

71 mud

Shelves

chipboard panels melamin plated

fixed to the structure through socket-head screws

Shelves finish

matt lacquer

matt lacquer extra

polish lacquer

polish lacquer extra

133 natural oak

158 black-stained oak

Notes

Note 1

Bookshelf can have shelves in different colours

Note 2

Bookshelf is fixed to wall through an expansion hook (fischer)

Code description

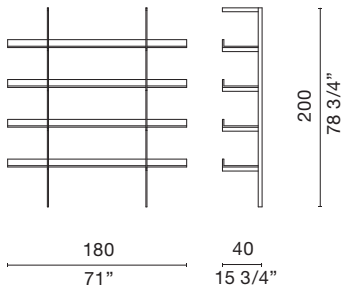

		matt lacquer	matt lacquer extra	polish lacquer	polish lacquer extra	wood
ALI20	Bookshelf with varnished structure	3.670	4.035	5.400	5.960	4.090
ALI2	Bookshelf with chromed structure	3.820	4.195	5.585	6.135	4.260

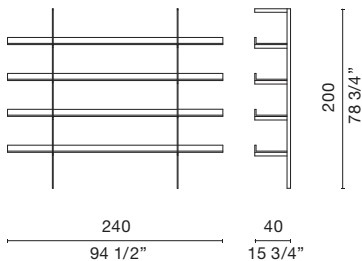

		matt lacquer	matt lacquer extra	polish lacquer	polish lacquer extra	wood
ALI30	Bookshelf with varnished structure	4.275	4.700	6.600	7.255	4.775
ALI3	Bookshelf with chromed structure	4.215	4.630	6.475	7.130	4.710

Double-face bookshelf characterised by a great visual lightness. All the compartments have different dimensions, according to Kuramata's idea that every object needs its own space.



Structure

medium-density fibre conglomerate panels

Structure finish

matt lacquer
01 white

Note

Open compartments have different dimensions

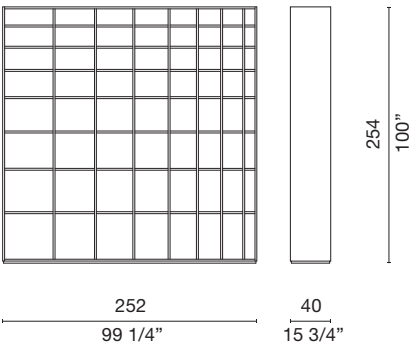
Code	description	Price
	 <p style="text-align: center;"> 252 $99\ 1/4''$ </p> <p style="text-align: center;"> 40 $15\ 3/4''$ </p> <p style="text-align: right;"> 254 $100''$ </p>	
PC_7	Double-face bookcase	18.575

Modular double-face bookshelf made of linear polyethylene manufactured with rotational technology. The elements can be combined, thus creating an infinite possibility of compositions.



Structure

white linear polyethylene

Finish

plastic 892 white

Clips

pressure clips to join modules together in white matt epoxy powder coated metal

Note

Note 1
Suitable for outdoor

Note 2
Hole dimension: Ø 34 cm

Code description

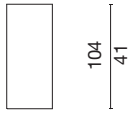
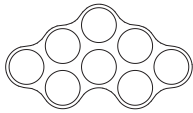

187,5
73 3/4"

44,5
17 1/4"

		Price
C5_1	Basic element	850

A column unit, produced in numbered series, made of 18 drawers opening on both sides.



Structure base

metal plate

Structure finish

painted in matt black

Drawers

medium-density wooden conglomerate melamin plated drawers

Drawers finish

matt lacquer
01 white

Feet

felt pads

Note

The item is sold in numbered edition

Code description

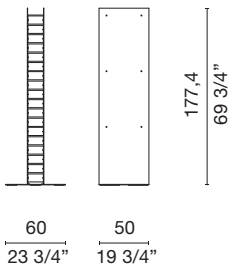

		Price
PC_20	Chest of drawers	13.900

Series of double-face bookcases in three different heights, made of thin laser-cut metal plate matt varnished in a selection of colours.



Structure

metal plate

Structure finish

matt varnished

01 white

04 black

71 mud

Feet

black plastic adjustable

Note

The low bookcase can also be used as a night stand

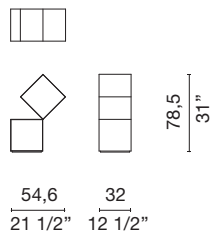
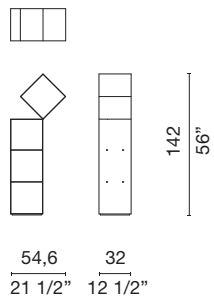
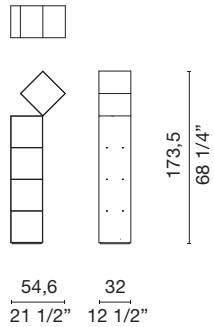
Code	description	Price
	Low bookcase	1.870
	Middle-height bookcase	2.810
	High bookcase	3.185

Series of cabinets for the living area, characterised by a great visual lightness. Available veneered or matt or polish lacquered, completed with different closing tops: lacquered, veneered or marble.



Cases and top

panels of wood particles covered in melamine desert finish

Finish

matt lacquer
matt lacquer extra
polish lacquer
polish lacquer extra

133 natural oak
158 black-stained oak

Top finish

matt lacquer
matt lacquer extra
polish lacquer
polish lacquer extra

133 natural oak
158 black-stained oak

521 white Carrara marble
528 grey Roma marble

Base

metal base with adjustable feet, frame H. 16 cm
matt varnished 04 black

Handles

Knob and Push-pull, Handles
to be ordered separately (price to be added)

Handles finish

matt varnished
matt varnished extra

Hinges

leaf doors are equipped with hinges with integrated soft-close mechanism

Notes

Note 1

With matt or polish external finish, internal finish is always matt in the same colour as the external one

With veneered external finish, internal finish is always melamine, desert colour

The internal finish of the drawers is always melamine, desert colour

Note 2

Open compartments always follow the external finish of the cases

Note 3

Cases and shelves with width 120 cm have always a metal support bar in coordinate colour

Note 4

For compositions height till 68 cm, the base is 30 cm smaller in width than the composition, on each side; for compositions height more than 68 cm, the base is 15 cm smaller in width than the composition, on each side

Note 5

The glass case always follows the colour of the outside finish of the composition; for cases with outside finish in wood, the glass case follows the colour of the base

Note 6

The lower closing tops are not available in marble

Note 7

In case of lacquered containers, the colour of the handles is always the same as the case

In case of veneered containers, the colour of the handles is always the same as the basement

Code description

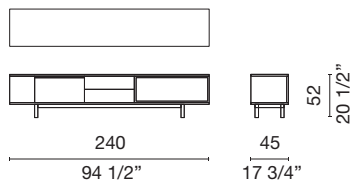

		matt lacquer	matt lacquer extra	polish lacquer	polish lacquer extra	wood	Marble
EAS4	Container	5.130	5.370	5.865	6.220	4.630	
EAST24	Top	770	855	1.260	1.385	995	3.540
EASB24	Lower top	770	855	1.260	1.385	995	

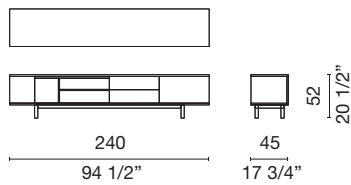

		matt lacquer	matt lacquer extra	polish lacquer	polish lacquer extra	wood	Marble
EAS11	Container	5.635	6.045	6.270	6.800	4.835	
EAST24	Top	770	855	1.260	1.385	995	3.540
EASB24	Lower top	770	855	1.260	1.385	995	

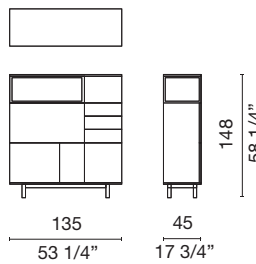

		matt lacquer	matt lacquer extra	polish lacquer	polish lacquer extra	wood	Marble
EAS3	Container	8.305	8.920	10.200	11.020	7.420	
EAST13	Top	510	490	725	775	575	2.000
EASB13	Lower top	450	490	725	775	575	

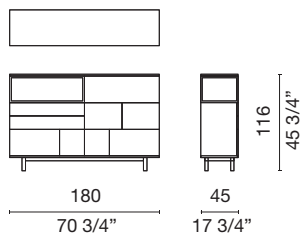

		matt lacquer	matt lacquer extra	polish lacquer	polish lacquer extra	wood	Marble
EAS20	Container	8.710	9.355	10.760	11.635	7.585	
EAST18	Top	585	645	945	1.050	750	2.665
EASB18	Lower top	585	645	945	1.050	750	

Push-pull

		Price
CRC	Pair of push-pull mechanisms for drawer	70
CRA	Push-pull mechanisms for leaf door	70
CRP	Pair of push-pull mechanisms for flap doors (for door width 60, 90 and 120)	70



		matt lacquer	matt lacquer extra
P22	Knob	90	100

Code description

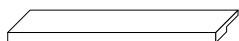
M05 - Lacquered handle

		matt lacquer	matt lacquer extra
M05015	width 15	140	145
M05024	width 24	150	155
M05039	width 39	160	165
M05054	width 54	185	190
M05084	width 84	225	230
M05114	width 114	250	255

EAS4

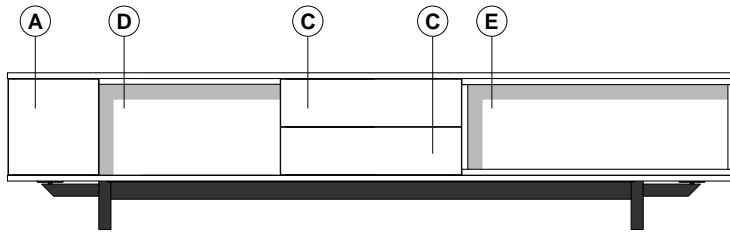

- A: leaf door
- B: flap door
- C: drawer
- D: open compartment
- E: glass case

EAS11

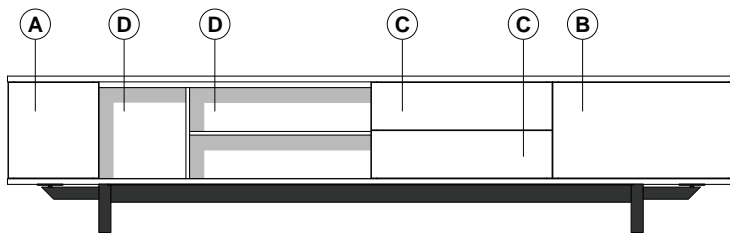

EAS3

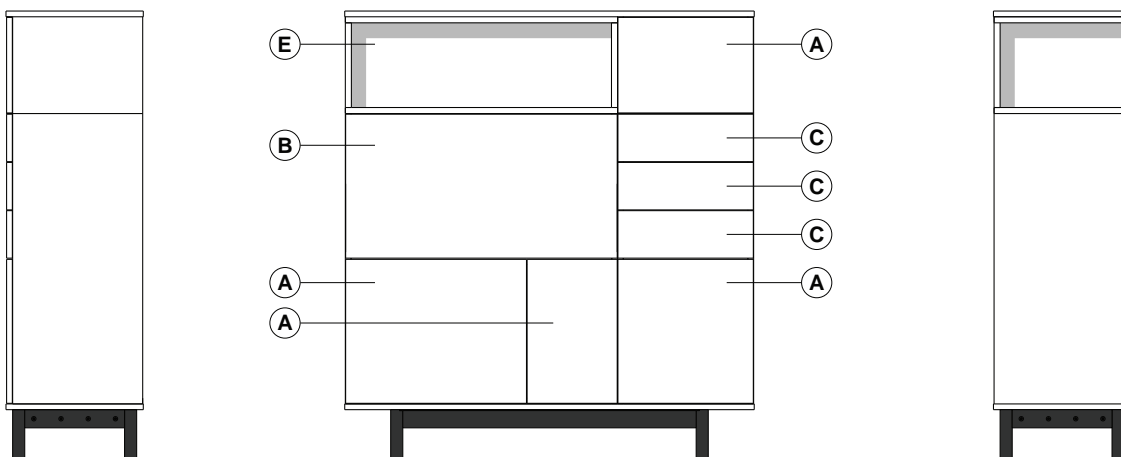

EAS20

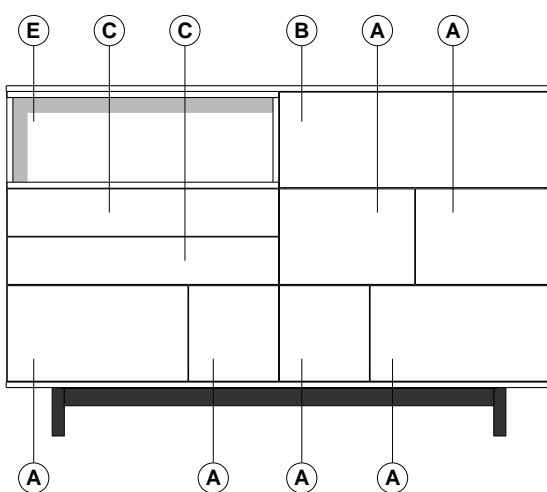

Wooden containers on casters, inspired by Piet Mondrian's graphic works.



Structure of case and fronts

medium-density fibre conglomerate panels

Finish for case and fronts

matt lacquer in two fixed colour matching black, white, blue, red and yellow colours

Base

swivel casters in grey rubber with chromed carter

Base support

black matt epoxy powder coated steel plate

Code description

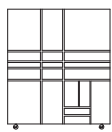

116
45 3/4"

99
39"

40
15 3/4"

Code	Description	Price
PC_19	Homage 1 - Cabinet - white/yellow front	15.680

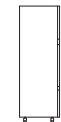
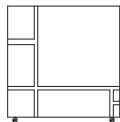

116
45 3/4"

112
44"

40
15 3/4"

Code	Description	Price
PC_18	Homage 2 - Cabinet - white/red/blue/yellow front	15.680

Series of containers, veneered or matt lacquered, with a full-length flap door or two leaf doors. The thin thickness of the cabinets makes their profile extremely graphic.



Structure

medium-density wood particles panels melamine plated

Finish

mat lacquer
 mat lacquer extra

 133 natural oak
 158 black-stained oak

Base

metal
 h. 36 cm: LH_1 / LH_2
 h. 20 cm: LH_3

Base finish

407 chromed

 matt varnished
 01 white
 04 black
 71 mud

Feet

in white plastic

Notes

Note 1
 Inner case and shelves finishes has the same colour and finishes of the outside

Note 2
 Upon request, containers LH_1 / LH_2 can be equipped with base h. 20 cm with an extra charge of 10%

Code	description			
LH_1	Cabinet 1 flap door only		matt lacquer	12.395
			matt lacquer extra	13.650
			wood	14.010
LH_2	Cabinet 1 flap door only		matt lacquer	10.465
			matt lacquer extra	11.515
			wood	11.810

Lochness

design: Piero Lissoni 2015

Code description

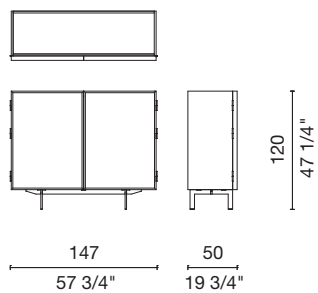

		matt lacquer	matt lacquer extra	wood
LH_3	Sideboard with 2 leaf doors	11.185	12.290	12.630

LH_1

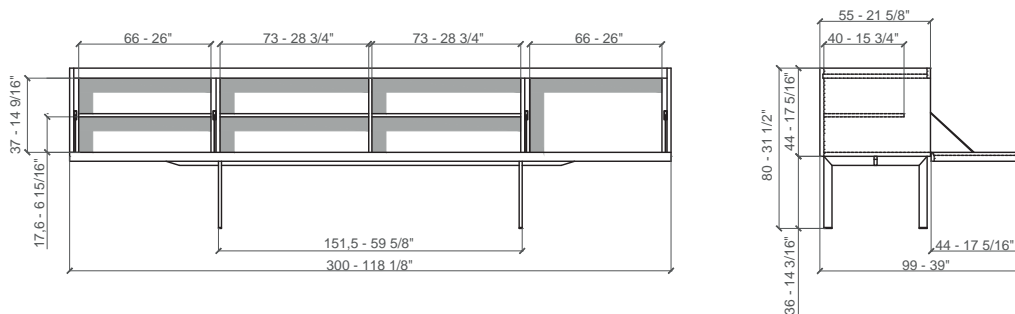

LH_2

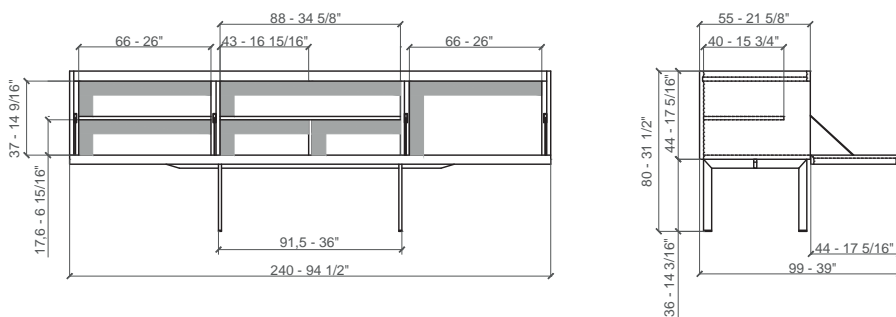

LH_3

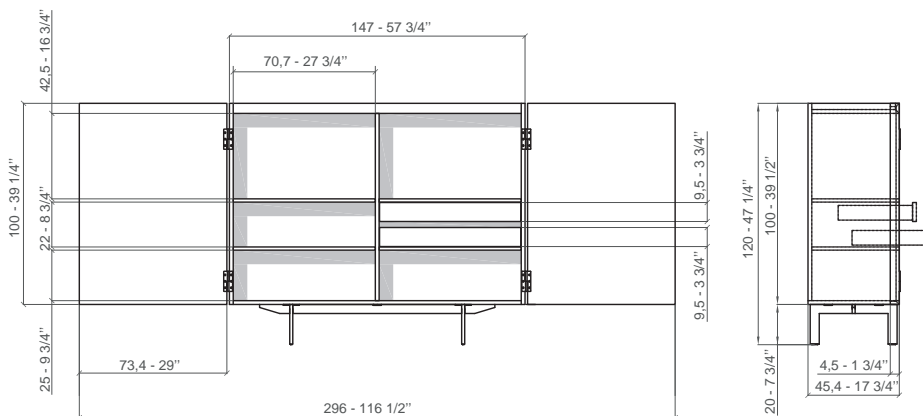

Series of containers with a very industrial aspect, suitable for both the living room and the office. Available matt or polish lacquered, with matt varnished metal base, same colour as the case.



Structure

medium-density fibre conglomerate panels

Doors, drawer front and shelves

poplar plywood covered with aluminium

Cases finish

matt lacquer
matt lacquer extra
polish lacquer
polish lacquer extra

Cases height

cm. 12, 36, 48, 72

Base

metal
low: 18 cm
high: 60 cm

Base finish

matt varnished, same colour as the case

Note

Cabinets with doors are equipped with shelves and drawers as per scheme

Code description

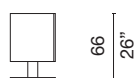
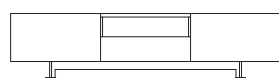

270
106 1/4"

45
17 3/4"

66
26"

LX_15 Cabinet with 1 drawer 2 doors

matt lacquer	matt lacquer extra	polish lacquer	polish lacquer extra
8.780	9.665	12.060	13.250

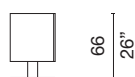
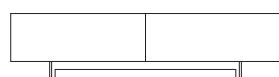

270
106 1/4"

45
17 3/4"

66
26"

LX_16 Cabinet with 2 sliding doors

matt lacquer	matt lacquer extra	polish lacquer	polish lacquer extra
12.500	13.735	17.460	19.195









180
70 3/4"

45
17 3/4"

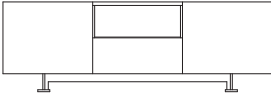
90
35 1/2"

LX_17 Cabinet with 2 doors

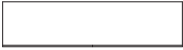
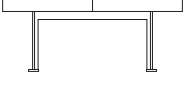
matt lacquer	matt lacquer extra	polish lacquer	polish lacquer extra
8.460	9.310	11.300	12.425

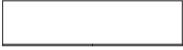
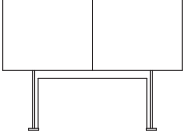
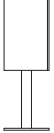
Code	description												
													
		270 106 1/4"	45 17 3/4"	90 35 1/2"									
LX_19	Cabinet with 2 doors and 1 open partition				<table border="1"> <tr> <td>matt lacquer</td> <td>matt lacquer extra</td> <td>polish lacquer</td> <td>polish lacquer extra</td> </tr> <tr> <td>10.585</td> <td>11.635</td> <td>15.165</td> <td>16.660</td> </tr> </table>	matt lacquer	matt lacquer extra	polish lacquer	polish lacquer extra	10.585	11.635	15.165	16.660
matt lacquer	matt lacquer extra	polish lacquer	polish lacquer extra										
10.585	11.635	15.165	16.660										
													
		270 106 1/4"	45 17 3/4"	90 35 1/2"									
LX_18	Cabinet with 3 doors				<table border="1"> <tr> <td>matt lacquer</td> <td>matt lacquer extra</td> <td>polish lacquer</td> <td>polish lacquer extra</td> </tr> <tr> <td>10.920</td> <td>12.000</td> <td>15.495</td> <td>17.030</td> </tr> </table>	matt lacquer	matt lacquer extra	polish lacquer	polish lacquer extra	10.920	12.000	15.495	17.030
matt lacquer	matt lacquer extra	polish lacquer	polish lacquer extra										
10.920	12.000	15.495	17.030										
													
		180 70 3/4"	45 17 3/4"	72 28 1/4"									
LX_8	Console with 2 drawers				<table border="1"> <tr> <td>matt lacquer</td> <td>matt lacquer extra</td> <td>polish lacquer</td> <td>polish lacquer extra</td> </tr> <tr> <td>5.275</td> <td>5.815</td> <td>6.380</td> <td>7.025</td> </tr> </table>	matt lacquer	matt lacquer extra	polish lacquer	polish lacquer extra	5.275	5.815	6.380	7.025
matt lacquer	matt lacquer extra	polish lacquer	polish lacquer extra										
5.275	5.815	6.380	7.025										
													
		180 70 3/4"	45 17 3/4"	132 52"									
LX_3	Cabinet with 2 doors				<table border="1"> <tr> <td>matt lacquer</td> <td>matt lacquer extra</td> <td>polish lacquer</td> <td>polish lacquer extra</td> </tr> <tr> <td>8.715</td> <td>9.570</td> <td>11.380</td> <td>12.525</td> </tr> </table>	matt lacquer	matt lacquer extra	polish lacquer	polish lacquer extra	8.715	9.570	11.380	12.525
matt lacquer	matt lacquer extra	polish lacquer	polish lacquer extra										
8.715	9.570	11.380	12.525										

Inner partition scheme.

LX_3

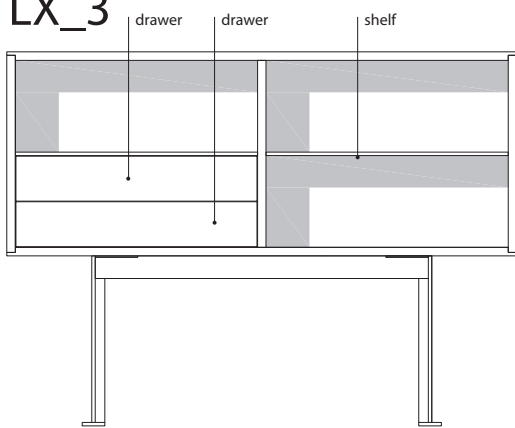

LX_17

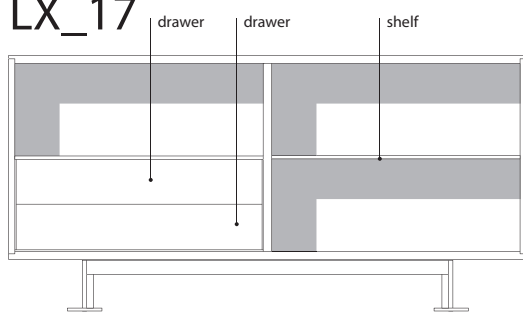

LX_16

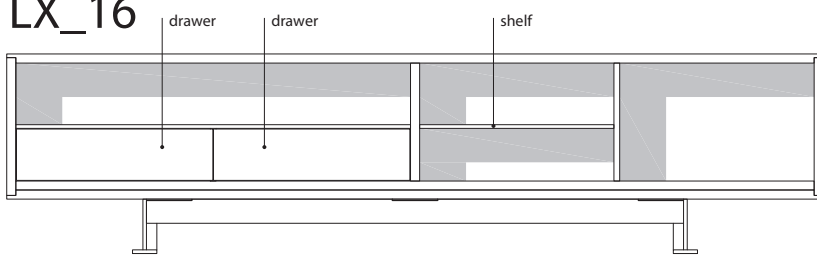

LX_18

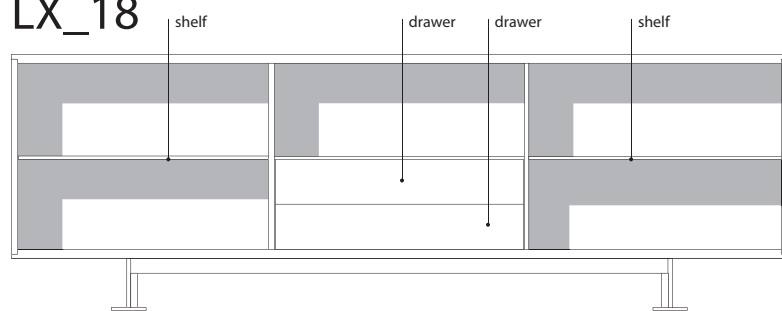

LX_19

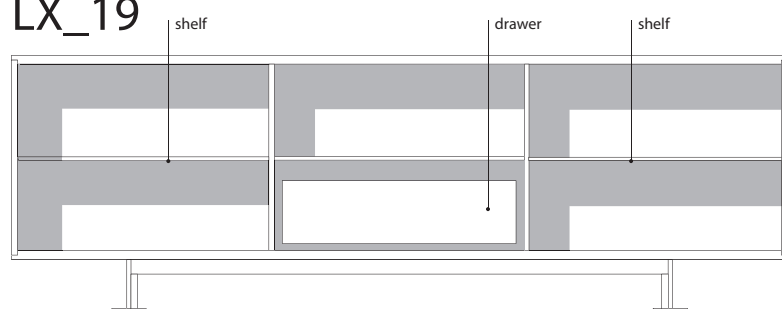

Series of chest of drawers, available in different shapes and dimensions, which combine sinuous and soft lines with more squared and geometric profiles.



Main structure

high-density wooden and fibre conglomerate panels and solid ash

Structure SIDE 2 PC_12 structure

112 black-stained ash

Drawers

matt lacquer
01 white

Base

casters in grey rubber

Knobs

brushed steel

SOLARIS structure

112 black-stained ash

Drawers

112 black-stained ash

Base

natural aluminium metal painted

Knobs

black painted metal

Code	description
------	-------------

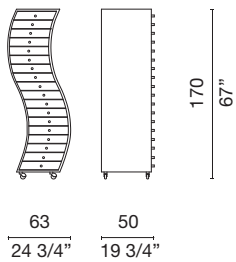

		Price
PC_3	Side 1 Curved chest of drawers	26.080

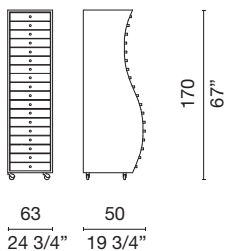

		Price
PC_6	Side 2 Curved chest of drawers	24.530

Code description

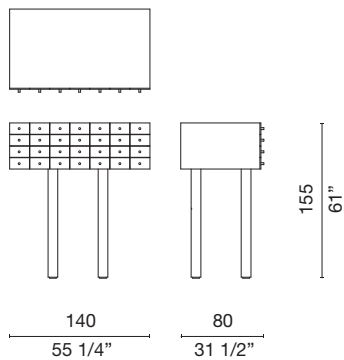

Code	description	Price
PC_8	Solaris Chest of drawers	28.585

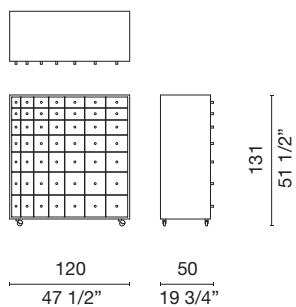

Code	description	Price
PC_12	Chest of drawers	42.530

Pyramid-shaped chest of drawers on casters manufactured in methacrylate with 17 drawers in different dimensions.



Structure

transparent methacrylate

Drawers

methacrylate (17 drawers in different dimensions)

Base

swivel casters in black rubber with chromed carter

Code description

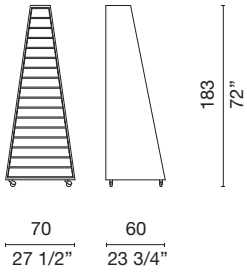

PC_16

Chest of drawers

Price

33.320

Chest of drawers made of acrylic plastic, with 20 drawers revolving round a metal support. A sculpture in movement, light and extremely innovative.



Base structure and vertical support

metal, black matt epoxy powder coated

Drawers

red polish acrylic plastic material
base cover in red polish acrylic plastic material

Feet

adjustable, in black plastic

Code description

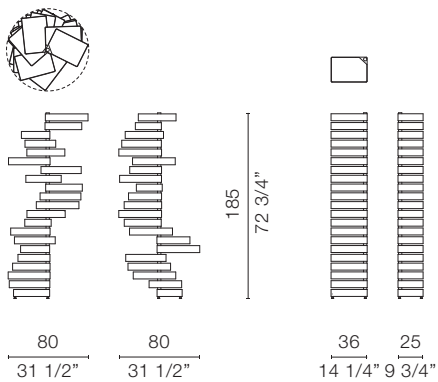

		Price
PC_15	Chest of drawers	3.250

Cabinets with doors and drawers characterised by a great formal lightness, available matt or polish lacquered in all the colours of the collection or oak veneered. Legs made of anodized aluminium.

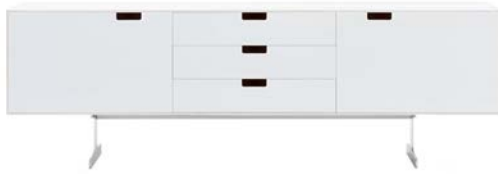

Structure

case, shelves, fronts and drawers in poplar plywood connected with aluminium

Case finish

matt lacquer
matt lacquer extra
polish lacquer
polish lacquer extra

133 natural oak
158 black-stained oak

Base

410 anodised aluminium

Feet

black plastic

Code description

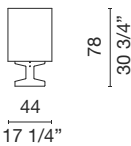
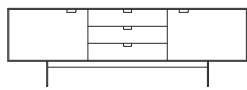

240
94 1/2"

44
17 1/4"

78
30 3/4"

	matt lacquer	matt lacquer extra	polish lacquer	polish lacquer extra	wood
S8_S1B Unit with 2 doors and 3 drawers	16.030	16.850	18.580	20.450	20.730

Series of large cabinets characterised by a minimal design, with leaf doors or drawers, available matt or polish lacquered in all the colours of the collection.



Structure

medium-density wooden conglomerate panels

Doors and drawers fronts

medium-density wooden conglomerate panels connected with aluminium

Base

solid laminate panels with metal frame support

Feet

grey felt

Finish

matt lacquer
matt lacquer extra
polish lacquer
polish lacquer extra

Drawers inside

chipboard panels coated with desert colour melamine

Notes

Note 1

Cabinets with doors UN_5Q, UN_6Q, UN_7Q e UN_8Q are equipped with an acidified glass shelf behind each door.
Cabinet UN_2BQ is equipped with three high drawers and an inner drawer in the central compartment.
Cabinet UN_9Q2 is equipped with two acidified glass shelves and one wooden shelf.
Cabinet UN_9Q is equipped with two mirror shelves and one inner drawer.

Note 2

The frame and the panels of the base are matt lacquered in the same colour as the cabinet

Note 3

The cabinets are equipped with base panel h. 15 cm th. 1 cm

Code description

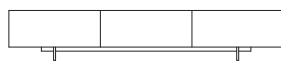

49
19 1/4"

270
106 1/4"

45,5
18"

		matt lacquer	matt lacquer extra	polish lacquer	polish lacquer extra
UN_2BQ	Cabinet with 3 drawers D. 45,5 - base h.15	6.350	6.960	8.420	9.250



67
26 1/2"

180
71"

45,5
18"

		matt lacquer	matt lacquer extra	polish lacquer	polish lacquer extra
UN_5Q	Cabinet with 2 doors D. 45,5 - base h.15	5.065	5.570	6.170	6.780

Code description

	matt lacquer	matt lacquer extra	polish lacquer	polish lacquer extra
UN_6Q Cabinet with 3 doors D. 45,5 - base h.15	7.065	7.735	8.675	9.535

	matt lacquer	matt lacquer extra	polish lacquer	polish lacquer extra
UN_9Q2 Cabinet with 2 doors D. 45,5 - base h.15	7.885	8.675	9.955	10.945
UN_9Q Cabinet with 2 doors D. 45,5 - base h.15	6.815	7.495	8.410	9.250

	matt lacquer	matt lacquer extra	polish lacquer	polish lacquer extra
UN_7Q Cabinet with 4 doors D. 45,5 - base h.15	8.075	8.855	10.185	11.205

	matt lacquer	matt lacquer extra	polish lacquer	polish lacquer extra
UN_8Q Cabinet with 6 doors D. 45,5 - base h.15	11.715	12.895	14.740	16.235

UN_2BQ

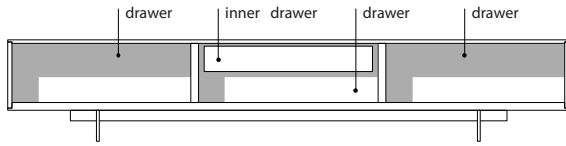

UN_5Q

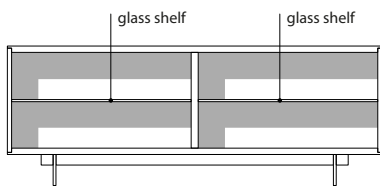

UN_6Q

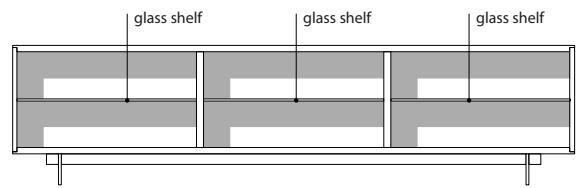

UN_9Q2

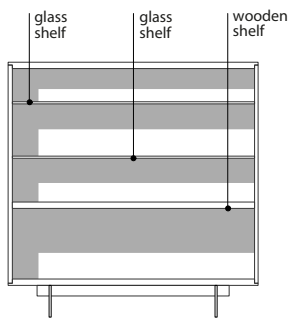

UN_9Q

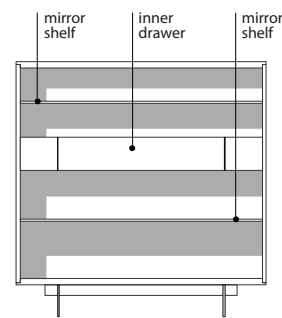

UN_7Q

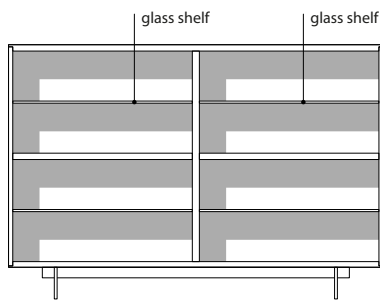

UN_8Q

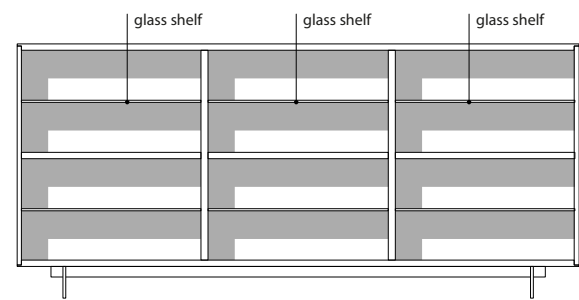

tables and service tables

Bac Table	<i>Jasper Morrison</i>	41
Bambi	<i>Nendo</i>	42
Bong	<i>Giulio Cappellini</i>	43
Branch Table	<i>Jakob Wagner</i>	44
Break	<i>Giulio Cappellini</i>	47
Cannot	<i>M. Catalano, I. Marelli</i>	49
Dolmen	<i>Giulio Cappellini</i>	50
Fronzoni '64	<i>AG Fronzoni</i>	51
Gong	<i>Giulio Cappellini</i>	52
Gong Circus	<i>Giulio Cappellini</i>	53
Gong Lux	<i>Giulio Cappellini</i>	54
Ko-Ko	<i>Shiro Kuramata</i>	55
Lochness	<i>Piero Lissoni</i>	56
Loop	<i>E. Barber & J. Osgerby</i>	59
Luce	<i>Giulio Cappellini & Antonio Facco</i>	60
Luxor	<i>Giulio Cappellini</i>	61
Millenium Hope	<i>Claudio Silvestrin</i>	62
Millepiedi	<i>Dimorestudio</i>	63
Mini Bottle	<i>E. Barber & J. Osgerby</i>	64
Miya	<i>Elena Salmistraro</i>	65
Mush	<i>Giulio Cappellini</i>	66
One Legged Table	<i>Jasper Morrison</i>	68
Openup	<i>Nik Aelbrecht</i>	69
Org	<i>Fabio Novembre</i>	71
Orgone Table	<i>Marc Newson</i>	72
Pinch	<i>Nendo</i>	73
Riga	<i>Marc Newson</i>	74
Simplon	<i>Jasper Morrison</i>	75
Smoke	<i>Marcel Wanders</i>	77
Thin Black Table	<i>Nendo</i>	78

Table with solid ash wood base and round or rectangular wooden top, ash veneered in a range of colours.



Structure base

solid ash

Structure Top

chipboard ash veneered panel with massiv ash edges

Finish

113 bleached ash
116 oak-stained ash
112 black-stained ash
118 blue Shanghai-stained ash

Feet

grey pads

Note

Free colour matching between top and base are not available

Code description

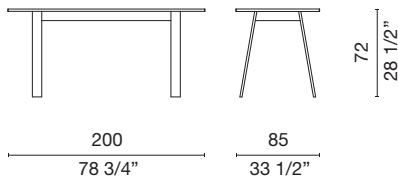
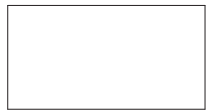

Code	description	Price
BAC1	Table wooden top	4.270

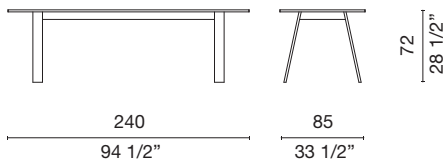

Code	description	Price
BAC2	Table wooden top	4.760

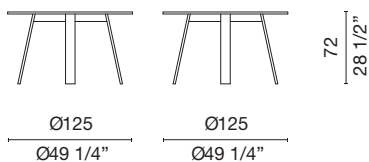
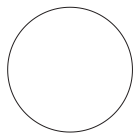

Code	description	Price
BAC4	Table wooden top	3.450

Desk with rectangular top made of laser-cut aluminium plate and legs in aluminium extrusion.



Top

aluminium plate cut by laser and folded up

Base

aluminium extruded with rectangular section

Finish

matt varnished

01 white

04 black

71 mud

Feet

black plastic

Code description



73
28 3/4"

150
59"

60
23 1/2"

		Price
BM_1	Table	3.645

Low spherical coffee table with round top made of fibre glass and resin, available in a selection of colours and finishes.



Structure

fibreglass and resin

Finish

matt lacquer

V19 white

V31 black

V24 red

V26 orange

V29 white Carrara

V20 Volcanic Lava

floral decoration

Feet

grey pads

Notes

Note 1

Fake marble and floral decoration is realized with Dip-Print three-dimensional decorating system

Note 2

The volcanic lava finish is made with lava stone powder from Etna, which allows to create similar yet unique pieces. For this reason, any differences in texture or colour are to be considered an added value

Code description



40
15 3/4"

Ø48
Ø 19"

Ø48
Ø 19"

		matt lacquer	fake marble	floral	volcanic lava
BG_1	Service table	1.030	1.225	1.410	1.455

Series of tables with die-cast aluminium base and top in different dimensions, available in matt lacquered wood, oak or glass.



Top

medium-density wooden fibre conglomerate panels

glass

Top finish

matt lacquer
matt lacquer extra

133 natural oak
158 black-stained oak

832 extralight glass
834 black back-painted glass
835 laminated mirror extralight glass

Base

base made of intertwined modules in die-cast aluminium

Base finish

407 polish chrome

matt varnished
01 white
04 black
71 mud

Feet

gray pads

Notes

Note 1

Undertop of tops in natural oak have a white lacquered edge
Undertop of tops in black-stained oak have a brown lacquered edge

Note 2

Laminated mirror extralight glass tops can be used with polish chromed aluminium base only

Code description

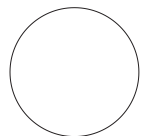

73
28 3/4"

Ø130
Ø 51 1/4"

Ø130
Ø 51 1/4"

		matt lacquered base	Chrome base
BR_1LA	Table with matt lacquered top	3.590	4.220
BR_1LE	Table with wooden top	3.310	3.925
BR_1V	Table with glass top	3.110	3.645
BR_1VR	Table with back-painted glass top	3.680	4.210
BR_1VS	Table with mirrored glass top		4.210

Branch Table

design: Jakob Wagner 2013 / 2023

Code description

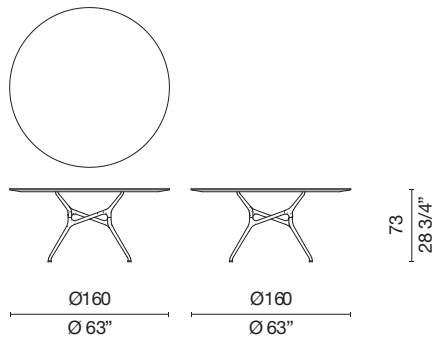

		matt lacquered base	Chrome base
BR_3LA	Table with matt lacquered top	5.135	6.040
BR_3LE	Table with wooden top	4.335	5.135
BR_3V	Table with glass top	4.335	5.085
BR_3VR	Table with back-painted glass top	5.100	5.865
BR_3VS	Table with mirrored glass top		5.865

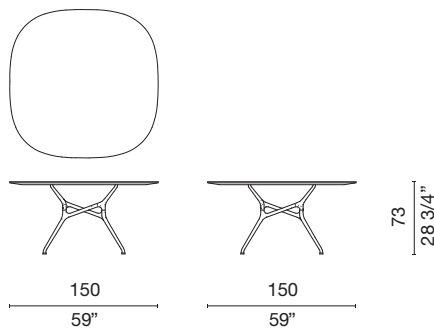

		matt lacquered base	Chrome base
BR_2LA	Table with matt lacquered top	4.880	5.730
BR_2LE	Table with wooden top	4.305	5.095
BR_2V	Table with glass top	4.095	4.795
BR_2VR	Table with back-painted glass	4.870	5.570
BR_2VS	Table with mirrored glass top		5.570

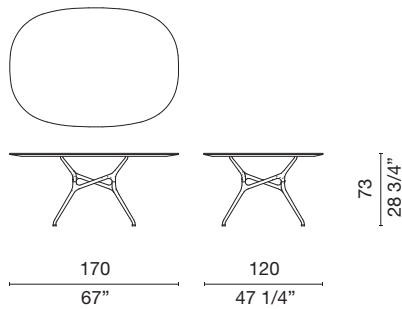

		matt lacquered base	Chrome base
BR_5LA	Table with matt lacquered top	4.525	5.335
BR_5LE	Table with wooden top	4.180	4.965
BR_5V	Table with glass top	3.980	4.675
BR_5VR	Table with back-painted glass	4.510	5.205
BR_5VS	Table with mirrored glass top		5.205

Branch Table

design: Jakob Wagner 2013 / 2023

Code description

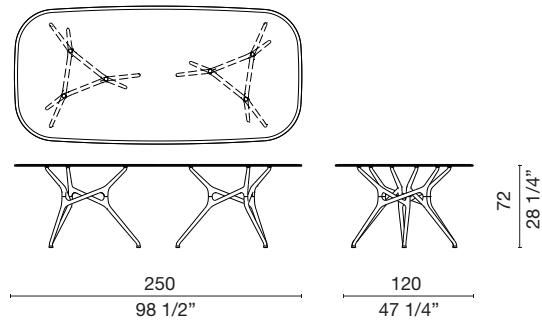

		matt lacquered base	Chrome base
BR_6LA	Table with matt lacquered top	5.720	6.455
BR_6LE	Table with wooden top	4.895	5.500
BR_6V	Table with glass top	5.195	6.140
BR_6VR	Table with back-painted glass top	5.920	6.850

Series of tables with stainless steel base and round or square top available in matt lacquered wood, oak, marble or laminate.



Top

medium-density wooden and fibre conglomerate panel, rim in solid wood

Top finish

matt lacquer
matt lacquer extra

133 natural oak
158 black-stained oak

521 white Carrara marble

white laminate
black laminate

Base

435 satined stainless steel

matt varnished
01 white
04 black
71 mud

Feet

black felts

Code description

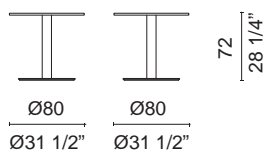

	matt lacquer	matt lacquer extra	wood	Laminate	white Carrara marble
BE_2AL Table with round top	2.360	2.545	2.610	2.055	2.990

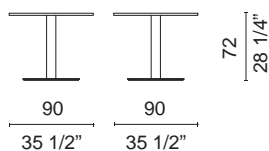

	matt lacquer	matt lacquer extra	wood	Laminate	white Carrara marble
BE_3AL Table with square top	2.485	2.690	2.770	2.185	3.605

Break

design: Giulio Cappellini 1999 / 2003

Code description

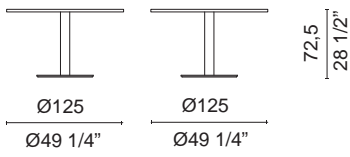
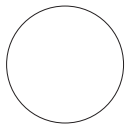

		matt lacquer	matt lacquer extra	wood	Laminate	white Carrara marble
BBE1AL	Table with round top	2.815	3.085	3.320	2.460	4.220

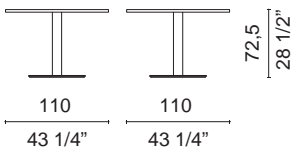
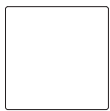

		matt lacquer	matt lacquer extra	wood	Laminate	white Carrara marble
BBE2AL	Table with square top	2.595	2.860	3.085	2.285	4.300

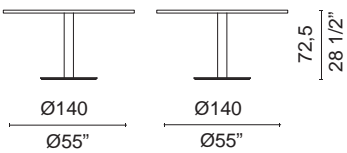
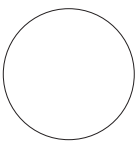

		matt lacquer	matt lacquer extra	wood	Laminate	white Carrara marble
BBE3AL	Table with round top	2.845	3.160	3.580	2.660	4.915

Service table with structure made of stainless steel and top matt or polish lacquered in all the colours of the collection.



Structure

435 satined stainless steel

Top

medium-density wooden conglomerate panel

Top finish

matt lacquer
matt lacquer extra
polish lacquer
polish lacquer extra

Feet

black plastic

Note

Maximum load on top centre: 100 Kg

Code description



45
17 3/4"

Ø55

Ø55

Ø21 1/2" Ø21 1/2"

		matt lacquer	matt lacquer extra	polish lacquer	polish lacquer extra
CI_1	Service table	1.240	1.380	1.435	1.560

Marble table available in two different dimensions with oval top, 3 cm thick, lying on two loose semicircular bases in the same material.



Top and base

521 white Carrara marble
526 green Alps marble
527 light straw-yellow travertine
528 grey Roma marble

Feet

grey felt

Notes

Note 1

Marble top th. 3 cm

Note 2

The marble is brushed finished with diamond wheels, with water-repellent treatment

Note 3

The straw yellow travertine version is processed with coloured cement grouting

Code description

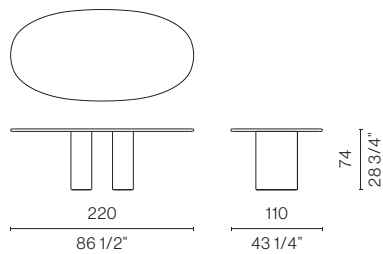

	Green Alps marble	Light straw-yellow travertine	white Carrara marble	Grey Roma marble
DOL1 Marble table	16.775	15.475	14.170	15.025

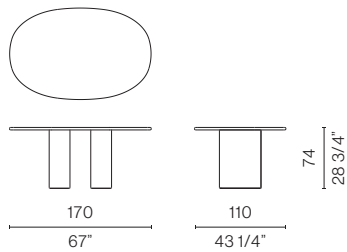

	Green Alps marble	Light straw-yellow travertine	white Carrara marble	Grey Roma marble
DOL2 Marble table	13.660	12.895	11.615	12.315

Series of square or rectangular tables characterized by a great geometric rigour. Base made of square metal tube and wooden top.



Top

medium-density wooden conglomerate panel

Top finish

matt lacquered
01 white
04 black

Base

square metal tube

Base finish

matt varnished
01 white
04 black

Feet

black plastic

Code description

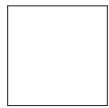

30.5
12 3/4"

100
39 1/4"

100
39 1/4"

FR_21 Service table

matt lacquer

1.485

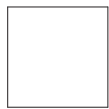

72.5
28 1/2"

100
39 1/4"

100
39 1/4"

FR_26 Table

matt lacquer

1.610



72.5
28 1/2"

100
39 1/4"

200
78 3/4"

FR_27 Table

matt lacquer

2.350

Service table characterised by a very minimal design, available in two dimensions, made of two round laser-cut metal plates linked through a thin rod.



Base

metal sheet

Stem

iron rod

Top

metal sheet

Finish

matt varnished

01 white

04 black

71 mud

Feet

grey felt pads

Note

Free colour matching for base, stem and top are not available

Code description

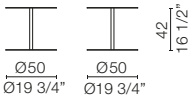

		Price
GG_1	Service table	505

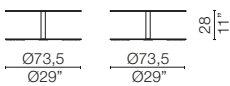

		Price
GG_2	Low service table	985

Service table characterised by a very ironic look, inspired by the graphics of the 50s, with tabletop matt varnished and serigraph printed in segments available in three fixed colour combination.



Base

metal sheet

Base finish

01 white
RAL 6021 pale green
RAL 3016 coral red

Stem

iron rod

Stem finish

04 black
RAL 6002 leaf green
RAL 3011 brown red

Top

metal sheet

Top finish

matt varnished and screen-printed with pie chart graphic in a fixed colour combination:
01 white/04 black
RAL 6021 pale green/RAL 6002 leaf green
RAL 3016 coral red/RAL 3011 brown red

Feet

black felt pads

Note

Free colour matching for top, stem and base is not available

Code description



42
16 1/2"

Ø50
Ø19 3/4

Ø50
Ø19 3/4

		Price
GG_1C	Service table	710

Service table, available in two dimensions, made of laser-cut metal plate polished lacquered with galvanic bath, which emphasises the simple and linear shape of the product.



Base

metal sheet

Stem

iron rod

Top

metal sheet

Finish

polish varnished
brass
metallic blue

Feet

grey felt pads

Notes

Note 1

Free colour matching for base, stem and top are not available

Note 2

The model GG_2 is available only with blue metallic finish

Code description

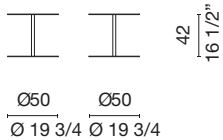

		Price
GG_1G	Service table	1.790

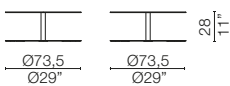

		Price
GG_2G	Low service table	2.690

Square service table made of ash wood enriched by a metal handle, which allows this piece also to be used as a seat.

**Structure**

medium-density conglomerate wooden panels

Structure finish

112 black-stained ash

Handle

polish chromed metal

Feet

black felt pads

Code description



61
24

45
17 3/4"

50
19 3/4"

		Price
PC_14	Service table	1.125

Tables and writing desks available in different dimensions with metal base and wooden top, matt lacquered or oak veneered in a selection of colours.



Top

medium-density wood particles panels melamine plated, wood veneered

Top finish

matt lacquered
matt lacquered extra

133 natural oak
158 black-stained oak

Base

metal

Base finish

407 chromed

matt varnished
01 white
04 black
71 mud

Feet

in white plastic

Note

Upon request, the tables LH_6 / LH_7 depth 90 cm can be ordered with an extra charge

Code description

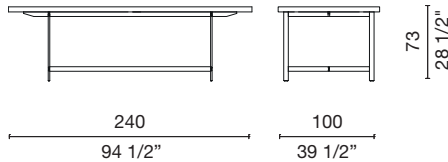
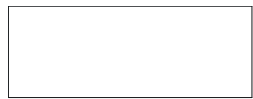

	matt lacquer	matt lacquer extra	wood
LH_6P Table	5.325	5.625	6.075

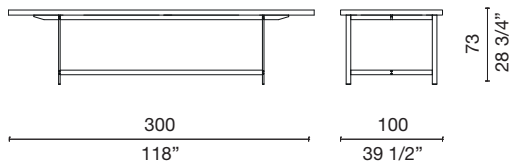

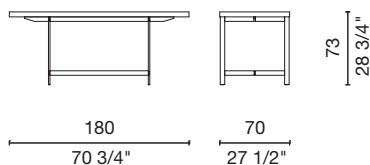

	matt lacquer	matt lacquer extra	wood
LH_7P Table	5.815	6.150	6.640

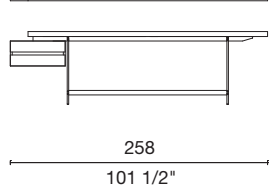
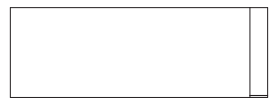
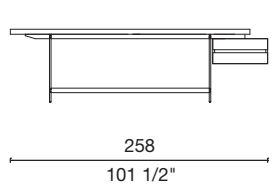

	matt lacquer	matt lacquer extra	wood
LH_5 Table	4.440	4.700	5.075

Code description

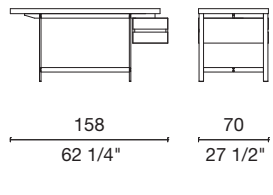
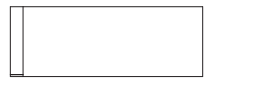
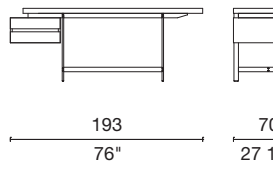
		matt lacquer	matt lacquer extra	wood
	<p>LH_8L Writing desk with left chest of drawers</p>	7.840	8.275	8.945
		matt lacquer	matt lacquer extra	wood
	<p>LH_8R Writing desk with right chest of drawers</p>	7.840	8.275	8.945
		matt lacquer	matt lacquer extra	wood
	<p>LH_9L Writing desk with left chest of drawers</p>	6.380	6.740	7.280
		matt lacquer	matt lacquer extra	wood
	<p>LH_9R Writing desk with right chest of drawers</p>	6.380	6.740	7.280
		matt lacquer	matt lacquer extra	wood
	<p>LH_10L Writing desk with left chest of drawers</p>	6.815	7.200	7.780

Lochness

design: Piero Lissoni 2015

Code description

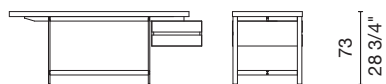

		matt lacquer	matt lacquer extra	wood
LH_10R	Writing desk with right chest of drawers	6.815	7.200	7.780

Desk with stainless steel base and bent and shaped plywood top, matt lacquered in all the colours of the collection.



Top

birch plywood

Top finish

matt lacquer
matt lacquer extra

Base

435 satin stainless steel

matt varnished
04 black

Feet

grey nylon

Code description

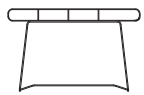
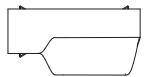

84
33"

135

53 1/4"

65

25 1/2"

		matt lacquer	matt lacquer extra
LP_21	Desk with satin base	5.035	5.530
LP_210	Desk with varnished base	4.940	5.385

Series of service tables made of coloured and laminated extra-clear glass, available in three different sizes, in a fixed colour combination.



Structure

5 sheets of coloured and laminated extra-clear glass

Finishes

set colour combination

- Red (Ral 3003)
- Bordeaux (Ral 3005)
- Blue (Ral 5003)
- Yellow (Ral 1003)
- Blue

Feet

transparent silicone rubber

Notes

Note 1

The table is provided with feet which can be fixed at the discretion of the customer

Note 2

The table can be used with the open side to the ground, or with upper, frontal or lateral open side, as a container of objects or magazines.

Code	description	Price
LUX1	Service table big	3.065
LUX2	Service table medium	2.910
LUX3	Service table small	2.790

Series of tables with a very industrial aspect, with wooden top matt or polish lacquered in all the colours of the collection and metal base matt varnished in the same colour as the top.



Top

medium density wooden fibre panel

Top finish

matt lacquer
matt lacquer extra
polish lacquer
polish lacquer extra

Base

metal

Base finish

matt varnished in the same colour of the top

Code description

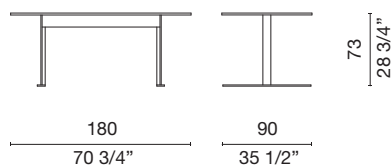

	matt lacquer	matt lacquer extra	polish lacquer	polish lacquer extra
LX_1 Table	3.960	4.345	4.620	5.090

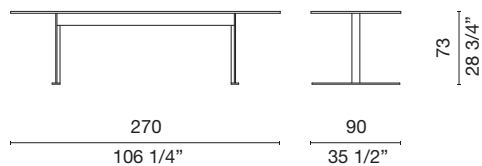

	matt lacquer	matt lacquer extra	polish lacquer	polish lacquer extra
LX_2 Table	4.935	5.420	5.800	6.375

Table made of oak wood, characterised by a great formal rigour. Matching bench in the same finishes as the table.



Structure

fir honeycomb, medium-density fibre conglomerate panels

Finish

133 natural oak
158 black-stained oak

Note

Upon request, the table MH_2R depth 80 cm can be ordered with an extra charge

Code	description	Price
MH_2RP	Table	6.845
MH_1R	Bench	3.225

Dining or meeting table with metal structure and elliptical tabletop, available in matt or polish lacquered wood, in a selection of colours, or in marble.



Base

thick metal and brass pipes, connected together, and support plate for the top

Base finish

metal parts: powder coating black colour RAL 9005
brass parts: transparent varnish with horizontal frosting

Feet

black plastic, adjustable, with replaceable felt element

Top

medium-density wooden fibre conglomerate panels

marble

Top finish

matt lacquer
polish lacquer
polish lacquer extra

521 white Carrara marble
523 black Marquinia marble

Notes

Note 1

For the marble top version, in addition to the metal plates of the base, the table is equipped with a support HPL undertop

Note 2

When moved, the table has to be lifted from the plates of the base rather than directly from the top

Code description

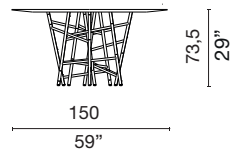
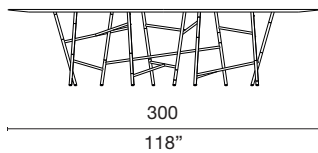
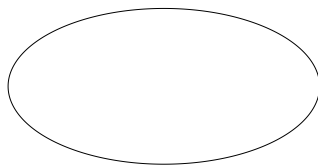

73.5
29"

Code	Description	matt lacquer	polish lacquer	polish lacquer extra	black Marquinia marble	white Carrara marble
MPI1	Table	11.055	12.065	13.225	14.435	15.095

Low service table made of handcrafted refractory ceramic.



Structure

hand-worked refractory ceramic

Structure finish

matt satined white CBI
matt satined black CNE

Base

black felt

Note

Handmade side table made by master ceramic craftsmen. Since they are high quality artisanal products, any irregularities or slight differences in colours are to be considered an added value

Code description



42
16 1/2"

Ø45

Ø45

Ø17 3/4" Ø17 3/4"

		Price
BTL4CE	Service table	1.605

Coffee table available in two sizes and colours combination, made of blown-glass parts combined with extralight glass sheet.



Top

transparent extralight tempered glass plate

Base

polish transparent blown glass

Internal element

blown glass available in the two following colors:
emerald green
avio blue

Underbase

double transparent extralight tempered glass plate

Feet

transparent silicone rubber

Note

The glasses of this service table are unique pieces, they are the result of the antique art of Italian Glass Makers. Any air bubbles or color differences, common in handmade glass products, are to be considered qualities

Code description

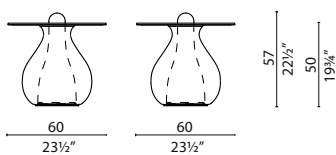
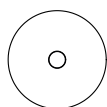

MYA1 High service table

Price

2.970

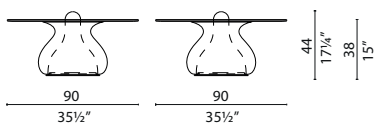
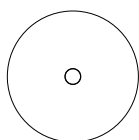

MYA2 Low service table

Price

3.650

Series of low tables available in two heights, with cylindrical metal base and tops in different materials and finishes.

**Base**

Metal

Base finish

407 chromed

matt painted
04 black**Top**

solid oak

metal

marble

Top finish

160 Cognac solid oak

161 Carbon solid oak

finish in a mixture of marble with irregular fragments, available in the following colors:

blue with aluminium fragments
white with blue marble fragments

521 white Carrara marble

Feet

Felt

Notes**Note 1**

Any colour variations of the oak are to be considered a valuable characteristic of the finish used

Note 2

Any variations in colour and homogeneity of the fragments contained in the marble mixture are to be considered a value of the material because each piece is handmade and therefore unique

Note 3

The oak and the marble mixture top can be used with black matt varnished base only

The white Carrara marble top can be used with polish chromed base only

Code	description
------	-------------

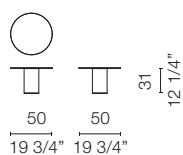

	Price
MU_1M Low side table with mixture of marble top	1.105

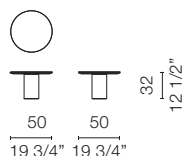

	Price
MU_1R Low side table with wooden top	1.465

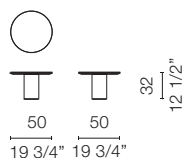

	Price
MU_1C Low side table with white Carrara marble top	1.750

Code description

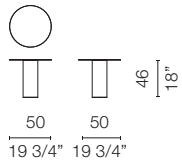

	Price
MU_2M High side table with mixture of marble top	1.255

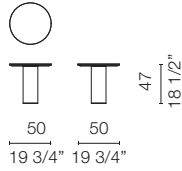

	Price
MU_2R High side table with wooden top	1.615

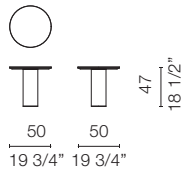

	Price
MU_2C High side table with white Carrara marble top	1.835

One-legged console with metal frame and tempered float glass top, sanblasted on every side.



Structure

metal frame

Structure finish

matt painted
O41 metallic grey
O42 metallic dark brown

Top

tempered float glass

Top finish

sanblasted on every side with satin-resistant transparent varnish

Feet

grey felt

Note

The glass top is propped up by four rubber spacers fixed on the frame

Code description

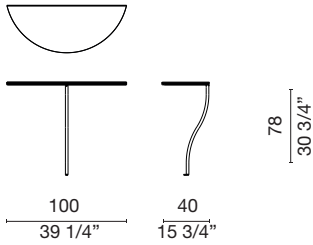

Code	Description	Price
OLT1	Console	1.440

Series of tables available in different shapes and sizes, with laser-cut metal base and top made of ash veneered plywood.



Top

plywood panel

Top finish

113 bleached ash
112 black-stained ash

Base

laser-cut metal sheet

Base finish

matt painted
04 black
01 white

Feet

black plastic

Note

The table with the rectangular top has a base with off-center legs

Code	description
------	-------------

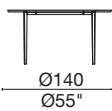
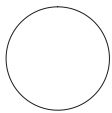

73
28"3/4

		Price
TOU1	Table with ash top	5.725

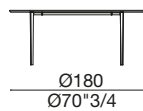
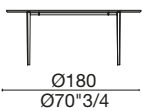
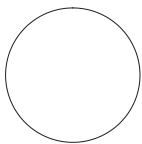

73
28"3/4

		Price
TOU2	Table with ash top	6.970

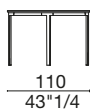
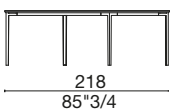

73
28"3/4

		Price
TOU3	Table with ash top	6.970

Code description

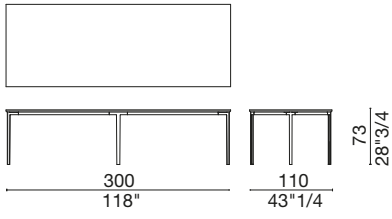

		Price
TOU4	Table with ash top	9.705

Small table and console with transparent glass top, characterised by the careful placement of flexible rope legs amidst rigid legs equipped with a steel core and rope exterior.



Top

transparent toughened glass

Base



stiff legs made of steel and polypropylene rope and flexible legs made of polypropylene rope

Base finish

- 611 white rope
- 612 red rope
- 613 black rope

Connecting elements

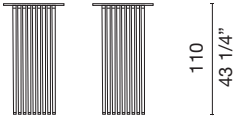
435 satined stainless steel

Code	description	Price
  $\frac{\text{Ø}60}{\text{Ø}23 \frac{3}{4}} \quad \frac{\text{Ø}60}{\text{Ø}23 \frac{3}{4}}$		
OG_2	Console	3.750
  $\frac{\text{Ø}60}{\text{Ø}23 \frac{3}{4}} \quad \frac{\text{Ø}60}{\text{Ø}23 \frac{3}{4}}$		
OG_5	Service table	3.430

Low table with four legs, manufactured in fiberglass polish lacquered in a selection of colours.



Structure

fibreglass with poplar plywood element

Finish

polish varnished
 802 orange
 803 red
 805 blue
 806 white
 807 black

Feet

black plastic

Note

Suitable for outdoor

Code description

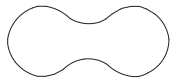

35
13 3/4"

160
63"

70
27 1/2"

Code	description	Price
MN_5	Service table	4.940

Collection of service tables with structure in metal tube and trays in solid cedar wood, engraved with the designer's signature and the Cappellini logo.



Structure

metal tube

Structure finish

black matt powder coating

Tray

solid cedar wood

Tray finish

191 raw natural cedar
192 black-stained cedar

Feet

black plastic caps

Notes

Note 1

Each tray is engraved under the top with the designer's signature and the Cappellini logo

Note 2

Since cedar is a wood belonging to the Pinaceae family, it is characterized by a pleasant balsamic fragrance released by the resin naturally contained in this wood essence

Note 3

Over time, the resin contained in solid cedar wood could emerge on the surface of the tray, resulting in texture and colour alterations

Note 4

Solid cedar wood is naturally characterised by the presence of knots, a signature feature of this material. Any movement, crack or colour variation is to be considered a value as they are synonymous with originality and authenticity

Code	description
------	-------------



59
23 1/4"

39
15 1/4"

39
15 1/4"

		Price
PIN1	Round service table	715

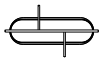

61
24"

72
28 1/4"

42
16 1/2"

		Price
PIN2	Side service table	910

Wooden desk matt lacquered in all the colours of the collection.



Structure

medium-density fibre conglomerate panels, legs in solid ash

Finish

matt lacquer
matt lacquer extra

Feet

tips in anodized aluminium

Note

Drawers with handles in anodized aluminium

Code description

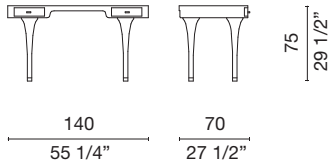

		matt lacquer	matt lacquer extra
MN_51	Desk	7.670	8.445

Series of tables and service tables with base made of anodised aluminium and top in poplar plywood and aluminium, matt or polish lacquered or oak veneered. The service table is also available with marble top.



Top

poplar plywood connected with aluminium

marble (only S8_P1)

Top finish

matt lacquer
matt lacquer extra
polish lacquer
polish lacquer extra

133 natural oak
158 black-stained oak

521 white Carrara marble (only S8_P1)
528 grey Roma marble (only S8_P1)

Base

410 anodised aluminium

Feet

white

Code description

Code	description	matt lacquer	matt lacquer extra	polish lacquer	polish lacquer extra	wood
S8_T1	Table	6.080	6.305	6.625	6.940	6.390
S8_T2	Table	6.080	6.345	6.715	6.970	6.555
S8_T4	Table	8.455	8.775	9.190	9.665	8.920

Code description

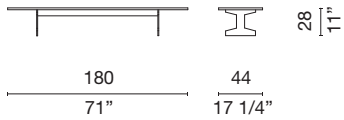



		matt lacquer	matt lacquer extra	polish lacquer	polish lacquer extra	wood	white Carrara marble	Grey Roma marble
S8_P1	Service table	3.595	3.420	3.965	3.760	3.385	3.830	4.210

Square or rectangular low service table made of toughened glass.

Structure

smoked toughened glass (top and upper part of sides)
transparent toughened glass (lower part of sides)

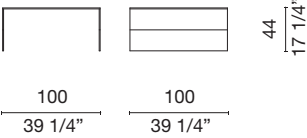

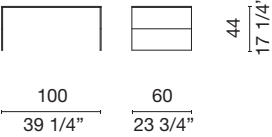
Code	description	Price
		
		
SM_1	Service table	2.315
		
		
SM_2	Service table	1.805

Low table with iron structure and extralight glass top, characterised by the intersection of two offset cubes, which create a game of joints and transparencies.



Structure

square metal bar

Structure finish

matt varnished
04 black

Top

square with extralight glass

Feet

black rubber tips

Notes

Maximum load on top centre 50 kg
Maximum bearable weight 2,8 kg on its protruding corners

Code description



51
20"

46
18 1/2"

47
18 1/2"

TBT1 Service table

1.415

sofas and armchairs

And	<i>Fabio Novembre</i>	80
Basket	<i>Ronan & Erwan Bouroullec</i>	81
Big Sofa	<i>BIG</i>	83
Cap Martin Sunset	<i>Carlo Colombo</i>	84
Capo	<i>Doshi&Levien</i>	92
Cuba 25	<i>Rodolfo Dordoni</i>	93
Cuba 25 Sofa-Bed	<i>Rodolfo Dordoni</i>	97
Dalia	<i>Marcel Wanders</i>	100
Daybed	<i>Jasper Morrison</i>	101
Drum	<i>Mac Stopa</i>	102
Elan	<i>Jasper Morrison</i>	107
Elan 23	<i>Jasper Morrison</i>	110
Embroidery Chair	<i>Johan Lindstèn</i>	112
Embryo Chair	<i>Marc Newson</i>	113
Felt Chair	<i>Marc Newson</i>	114
Fronzoni '64	<i>AG Fronzoni</i>	115
Gambetta	<i>Jasper Morrison</i>	116
Hiroi	<i>Matěj Janský & Cyril Dunděra</i>	118
Hobo Contract	<i>Tina Bunyaprasit & Werner Aisslinger</i>	119
InOut	<i>Jean-Marie Massaud</i>	122
Knotted Chair	<i>Marcel Wanders (Droog Design)</i>	123
Litos	<i>Sebastian Herkner</i>	124
Lotus (Attesa)	<i>Jasper Morrison</i>	128
Low Pad	<i>Jasper Morrison</i>	131
Lud'o Lounge	<i>Patricia Urquiola</i>	132
Newood Relax	<i>BrogliatoTraverso</i>	134
Newood Relax Light	<i>BrogliatoTraverso</i>	135
Oblong Plus	<i>Jasper Morrison</i>	136
Orgone	<i>Marc Newson</i>	138
Orla	<i>Jasper Morrison</i>	139
Peacock	<i>Dror</i>	142
Peg Armchair	<i>Nendo</i>	143
Proust	<i>Alessandro Mendini</i>	144
Proust Geometrica	<i>Alessandro Mendini</i>	145
Rive Droite	<i>Patrick Norguet</i>	146
Serie 3088	<i>Piero Lissoni</i>	147
Sofa with Arms	<i>Shiro Kuramata</i>	148
Spring	<i>Erwan Bouroullec</i>	149
Sunset	<i>Christophe Pillet</i>	150
Thinking Man's Chair	<i>Jasper Morrison</i>	151
Three Sofa de Luxe	<i>Jasper Morrison</i>	152
Tube Chair	<i>Joe Colombo</i>	154
Wanders' Tulip Armchair	<i>Marcel Wanders</i>	157
Wooden Chair	<i>Marc Newson</i>	158
Cushions		159

All items manufactured with polyurethane foam (moulded or in multidensity) correspond to Californian Technical Bulletin 117 - 2013, Section A part 1 and Section D part 2.

Following items can also be produced by request with polyurethane foams in accord to British Standard BS 5852 – 1982 part 2: Basket, Capo, Cuba 25, Cuba 25 Sofa-Bed, Dalia, Elan, Embryo Chair, Fronzoni '64, Lotus (Attesa), Low Pad, Orla, Peg, Proust, Rive Droite, Serie 3088, Sofa with Arms, Spring, Sunset, Three Sofa de Luxe, Wanders' Tulip Armchair.

Following items satisfy both BS 5852 and TB 117 standard with no need of specification or request by Customer: Drum DRU6, Gambetta, Hobo Contract, Sofa with Arms.

Recommended fabrics and leathers for cover are indicated on proper schedule: LIST OF FABRICS at the end of the price list.

Large-size modular sofa with endless combination possibilities. Fixed cover in fabrics and leathers of the collection.

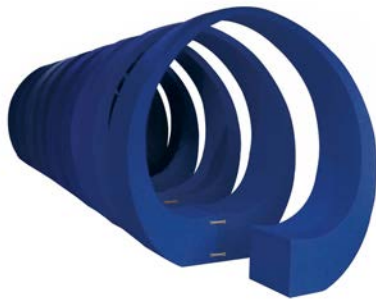

Structure

moulded polyurethane foam with metal frame, closing caps in upholstered poplar plywood

Cover

fixed in fabric and leather

Notes

Note 1

AND compositions can be fixed to the floor using the special fixing kit included or can simply be balanced with 6 special metal plates to be ordered separately; number of plates sets has to be verified with Cappellini according to Client's configuration

Note 2

Elements are hooked to one another with external hooks in anodized aluminium

Phil	A	A ₀	B	B ₀	C	D	E	E ₁	G	G ₂	V																							
•	•		•	•	•	•	•	•	•	•																								
	Frame	Vancouver	Sorrento	Sorrento rigato	Ecopelle	Trentino Stretto	Vancouver	Ambro	Bielastico Color	Bielastico Optical	Brecon	Corda	Madrid	Oceanic	Vancouver	Baltimore Plus Eco	Hallingdal 2	Panno	Steelcut Trio	Delft Velvet	Dunmore Plaid	Hardwick Plaid	Hero 2	Ivyside Herringbone	Market Street Plaid	Veroniet	Zero	Chandigar	Pelle	Pelle Extra	Spotted leather	Antemidor	Pucci Cotton / Velvet	Hide

Code description

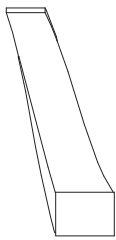

45
17 3/4"

245
96 1/2"

88
34 3/4"

110
43 1/4"

		cat. A	cat. B	cat. C	cat. D	cat. E	cat. G	cat. G ₂	fabric lmt	leather sqmt
DN_1	Basic unit	6.525	6.730	7.025	7.595	8.325	9.855	10.330	8,8	14,85



45
17 3/4"

113
44 1/2"

60
23 3/4"

		cat. A	cat. B	cat. C	cat. D	cat. E	cat. G	cat. G ₂	fabric lmt	leather sqmt
DN_2	Joining unit	2.775	2.860	2.905	3.035	3.195	3.745	3.940	2,2	5,5

			Price
DN_3	Set of 6 plates		1.015

Collection of seating elements with visible metal structure and padding in polyurethane foam. Removable cover in fabrics and leathers of the collection.



Structure

metal frame with tubes and laser-cut folded sheet metal

Structure finish

matt varnished
01 white
34 red
04 black
71 mud

Padding

multi-density polyurethane foam and acrylic fibre

Cover

removable in fabric and leather
upon request, the upholstery for each item can be ordered separately

Details

little rope in natural leather with stainless steel bush

Feet

white plastic on white structure
black plastic on coloured structures

Notes

Note 1

Seat: the seat cushions are fixed to the big cushion underneath through stitchings, and further connected to the structure with velcro

Note 2

Backs and armrests fixed to the structure: back cushions are joint together through a zip, while the armrests and back cushions are stitched together

Note 3

Loose backs and armrests cushions: all the backs and armrests loose cushions have the same dimension and density

	A	A _o		B	B _o	C				D			E				E ₁	G	G ₂	V	
●	Phill																				
●	Trame																				
●	Vancouver																				
	Sorrento																				
	Sorrento rigato																				
●	Ecopelle																				
●	Trentino Stretto																				
●	Vancouver																				
	Ambro																				
	Bleilastico Color																				
	Bleilastico Optical																				
●	Brecon																				
●	Conda																				
●	Madrid																				
●	Oceanic																				
●	Vancouver																				
●	Baltimore Plus Eco																				
●	Hallingdai 2																				
●	Panno																				
●	Steelcut Trio																				
●	Deift Velvet																				
●	Dunmore Plaid																				
●	Hardwick Plaid																				
●	Hero 2																				
●	Ivyside Herringbone																				
●	Market Street Plaid																				
	Veronnet																				
●	Zero																				
●	Chandigar																				
●	Pelle																				
●	Pelle Extra																				
	Spotted leather																				
	Artemidor																				
	Pucci Cotton / Velvet																				
	Hide																				

Code description



44
17 1/4"
82
32 1/4"

110
43 1/4"

90
35 1/2"

		cat. A	cat. B	cat. C	cat. D	cat. E	cat. G	cat. G ₂	fabric lmt	leather sqmt
BKT1	Big armchair	4.110	4.310	4.385	4.745	5.375	6.070	6.065	7,92	11,55

Basket

design: Ronan & Erwan Bouroullec 2005 / 2021

Code description

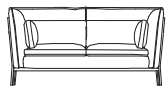
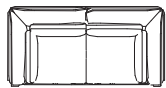

44
17 1/4"
82
32 1/4"

190
74 3/4"
90
35 1/2"

	cat. A	cat. B	cat. C	cat. D	cat. E	cat. G	cat. G2	fabric lmt	leather sqmt
BKT2 Two-seater sofa	6.400	6.670	6.860	7.555	8.865	9.945	10.370	12,1	18,7

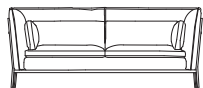
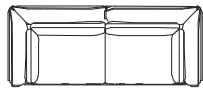

44
17 1/4"
82
32 1/4"

230
90 1/2"
90
35 1/2"

	cat. A	cat. B	cat. C	cat. D	cat. E	cat. G	cat. G2	fabric lmt	leather sqmt
BKT3 Three-seater sofa	7.585	7.915	8.080	8.895	10.390	11.605	12.045	14,3	20,9

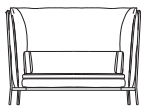
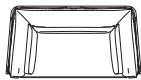

45
17 3/4"
120
47 1/4"

160
63"
90
35 1/2"

	cat. A	cat. B	cat. C	cat. D	cat. E	cat. G	cat. G2	fabric lmt	leather sqmt
BKT4H Small two-seater sofa - high backrest	6.455	6.835	7.730	9.210	10.540	11.900	12.605	14	24,7

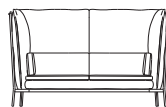

45
17 3/4"
120
47 1/4"

190
74 3/4"
90
35 1/2"

	cat. A	cat. B	cat. C	cat. D	cat. E	cat. G	cat. G2	fabric lmt	leather sqmt
BKT2H Two-seater sofa - high backrest	8.155	8.810	9.675	11.230	12.305	13.895	14.585	16	28,1

Collection of three or four seater benches, with base made of plywood and MDF and fixed cover in a selected range of fabrics and leathers from the collection.



Structure

conglomerate wooden panels

Padding

multi-density polyurethane foam

Base

plywood

Base finish

407 chromed

matt lacquered
04 black

Cover

fixed in fabric and leather

Note

The leather versions are equipped with a stitching along the seat and the backrest

Phill	A	A ₀	B	B ₀	C				D			E				E ₁	G	G ₂	V
	Trame		Sorrento		Blelastico Color														
	Vancouver		Sorrento rigato		Blelastico Optical														
			Ecopelle		Breson														
			Trentino Stretto		Conda														
			Vancouver		Madrid														
					Oceanic														
					Vancouver														
					Baltimore Plus Eco														
					Hallingdal 2														
					Panno														
					Steelcut Trio														
					Deft Velvet														
					Dunmore Plaid														
					Hardwick Plaid														
					Hero 2														
					Ivyside Herringbone														
					Marker Street Plaid														
					Veronmet														
					Zero														
					Chandigar														
					Pelle														
					Pelle Extra														
					Spotted leather														
					Artemidor														
					Pucci Cotton/Velvet														
					Hilde														

Code description

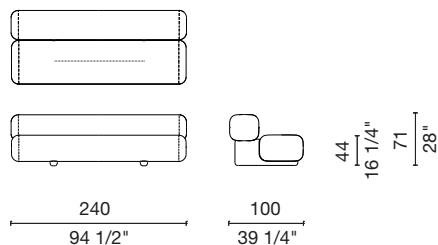

		cat. A	cat. B	cat. C	cat. D	cat. E	cat. G	fabric lmt	leather sqmt
PBS1	Three-seater bench with varnished base	7.660	8.035	8.370	8.885	9.385	10.900	6,6	11
PBS1C	Three-seater bench with chromed base	12.115	12.590	13.025	13.645	14.245	16.080	6,6	11

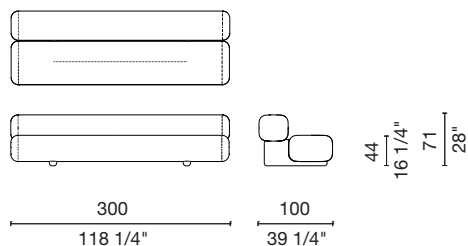

		cat. A	cat. B	cat. C	cat. D	cat. E	cat. G	fabric lmt	leather sqmt
PBS2	Four-seater bench with varnished base	8.880	9.335	9.745	10.380	11.005	12.770	7,7	13,2
PBS2C	Four-seater bench with chromed base	13.775	14.345	14.870	15.615	16.350	18.460	7,7	13,2

Seating system with metal tube base and removable cover in fabric or fixed cover in leather and ecoleather. Available with or without ribbon edge in a selection of colours.



Structure

structure made of metal and poplar plywood with elastic belts

Padding

multi-density polyurethane foam and fiber

Cover

removable in fabric and fixed in leather
upon request, the fabric upholstery for each model can be ordered separately

Base

metal tube

Base finish

407 chromed

matt painted

01 white

04 black

71 mud

Feet

adjustable with black plastic caps

Loose cushions

Loose cushions, removable covers, recommended to complete and made of feather, covered in the fabrics and leathers of the collection, available with or without gros-grain

Note

The edge of the upholstery has a gros-grain piping, available in the following colours: 88 amaranto, 41 nero, 168 castoro, 173 avio, 135 corda, 114 abisso

	A	A ₀	B	B ₀	C		D		E				E ₁	G	G ₂	V
•	Phill															
•	Triame															
•	Vancouver															
	Sorrento															
	Sorrento rigato															
•	Ecopelle															
	Trentino Stretto															
	Vancouver															
	Ambro															
	Bielastico Color															
	Bielastico Optical															
	Brescon															
•	Corda															
•	Madrid															
•	Oceanic															
•	Vancouver															
	Baltimore Plus Eco															
	Hallingdal 2															
•	Panno															
•	Steelcut Trio															
•	Delft Velvet															
•	Dunmore Plaid															
•	Hardwick Plaid															
•	Hero 2															
•	Ivyside-Herringbone															
•	Market Street Plaid															
•	Veronnet															
•	Zero															
•	Chandigar															
•	Pelle															
•	Pelle Extra															
	Spotted leather															
	Artemidor															
	Pucci Cotton/ Velvet															
	Hide															

Code description

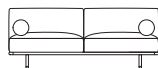

70
27 1/2"

38

15"

180

95,5

70 3/4"

37 1/2"

		cat. A	cat. B	cat. C	cat. D	cat. E	cat. E1	cat. G	cat. G2	fabric lmt	leather sqmt
MS_2	Two-seater sofa with lacquered base	5.855	6.120	6.400	7.025	7.480	9.060	9.060	9.395	6,5	11
MS_2C	Two-seater sofa with chromed base	6.560	6.780	7.225	7.935	8.465	9.570	9.570	9.935	6,5	11

Cap Martin Sunset

design: Carlo Colombo 2019

Code description

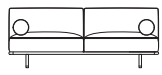
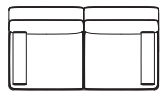

70
27 1/2"
38
15"

180
70 3/4"
95,5
37 1/2"

		cat. A	cat. B	cat. C	cat. D	cat. E	cat. E1	cat. G	cat. G2	fabric lmt	leather sqmt
MS_2P	Two-seater sofa with piping and lacquered base	6.325	6.610	6.915	7.595	8.085	9.935	9.935	10.285	6,5	11
MS_2CP	Two-seater sofa with piping and chromed base	7.280	7.500	7.945	8.680	9.220	10.350	10.350	10.725	6,5	11

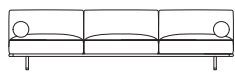
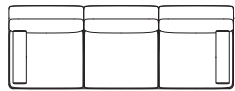

70
27 1/2"
38
15"

270
106 1/4"
95,5
37 1/2"

		cat. A	cat. B	cat. C	cat. D	cat. E	cat. E1	cat. G	cat. G2	fabric lmt	leather sqmt
MS_3	Three-seater sofa with lacquered base	7.495	7.935	8.465	9.270	9.995	12.220	12.220	12.735	9	15
MS_3C	Three-seater sofa with chromed base	8.615	9.050	9.570	10.455	11.265	12.655	12.655	13.105	9	15

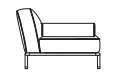
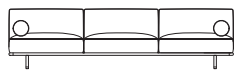
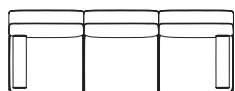

70
27 1/2"
38
15"

270
106 1/4"
95,5
37 1/2"

		cat. A	cat. B	cat. C	cat. D	cat. E	cat. E1	cat. G	cat. G2	fabric lmt	leather sqmt
MS_3P	Three-seater sofa with piping and lacquered base	8.535	8.985	9.520	10.350	11.075	13.340	13.340	13.855	9	15
MS_3CP	Three-seater sofa with piping and chromed base	9.675	10.115	10.650	11.540	12.370	13.790	13.790	14.230	9	15



70
27 1/2"
38
15"

90
35 1/2"
95,5
37 1/2"



70
27 1/2"
38
15"

90
35 1/2"
95,5
37 1/2"

		cat. A	cat. B	cat. C	cat. D	cat. E	cat. E1	cat. G	cat. G2	fabric lmt	leather sqmt
MS_4L	Left end element with lacquered base	3.250	3.475	3.760	4.130	4.580	5.145	5.145	5.310	5,6	6,5
MS_4LC	Left end element with chromed base	3.910	4.115	4.410	4.865	5.390	5.585	5.585	5.745	5,6	6,5
MS_4R	Right end element with lacquered base	3.250	3.475	3.760	4.130	4.580	5.145	5.145	5.310	5,6	6,5
MS_4RC	Right end element with chromed base	3.910	4.115	4.410	4.865	5.390	5.585	5.585	5.745	5,6	6,5

Cap Martin Sunset

design: Carlo Colombo 2019

Code description

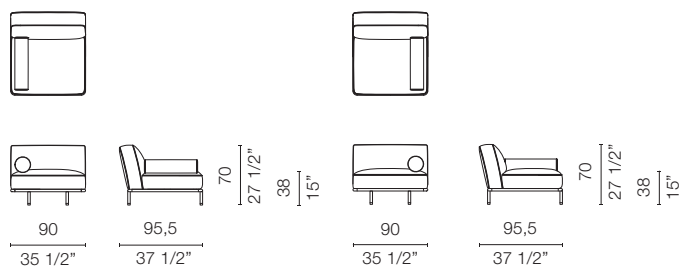

		cat. A	cat. B	cat. C	cat. D	cat. E	cat. E1	cat. G	cat. G2	fabric lmt	leather sqmt
MS_4LP	Left end element with piping and lacquered base	3.605	3.835	4.130	4.505	4.955	5.545	5.545	5.705	5,6	6,5
MS_4LCP	Left end element with piping and chromed base	4.280	4.490	4.795	5.250	5.775	5.980	5.980	6.150	5,6	6,5
MS_4RP	Right end element with piping and lacquered base	3.605	3.835	4.130	4.505	4.955	5.545	5.545	5.705	5,6	6,5
MS_4RCP	Right end element with piping and chromed base	4.280	4.490	4.795	5.250	5.775	5.980	5.980	6.150	5,6	6,5

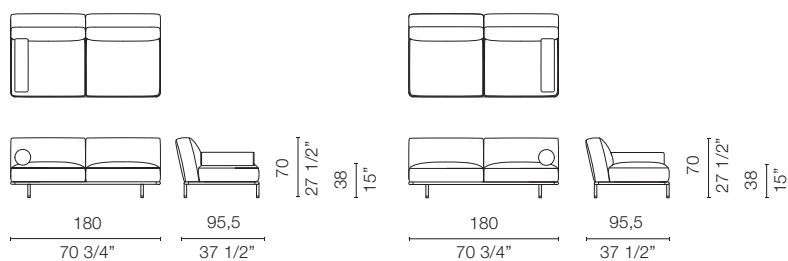

		cat. A	cat. B	cat. C	cat. D	cat. E	cat. E1	cat. G	cat. G2	fabric lmt	leather sqmt
MS_5L	Two-seater left end element with lacquered base	5.310	5.665	5.965	6.610	7.225	8.685	8.685	9.120	6,5	11
MS_5LC	Two-seater left end element with chromed base	6.190	6.485	6.925	7.515	8.030	9.135	9.135	9.420	6,5	11
MS_5R	Two-seater right end element with lacquered base	5.310	5.665	5.965	6.610	7.225	8.685	8.685	9.120	6,5	11
MS_5RC	Two-seater right end element with chromed base	6.190	6.485	6.925	7.515	8.030	9.135	9.135	9.420	6,5	11

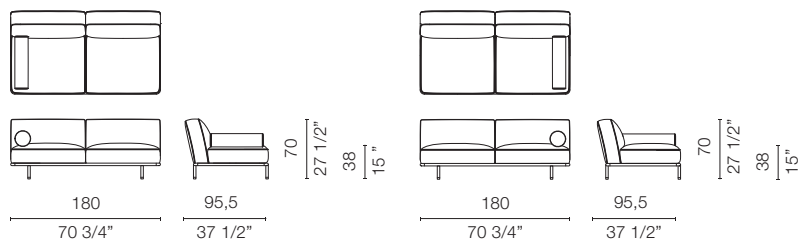

		cat. A	cat. B	cat. C	cat. D	cat. E	cat. E1	cat. G	cat. G2	fabric lmt	leather sqmt
MS_5LP	Two-seater left end element with piping and lacquered base	6.000	6.375	6.675	7.340	7.945	9.440	9.440	9.885	6,5	11
MS_5LCP	Two-seater left end element with piping and chromed base	6.905	7.200	7.655	8.240	8.775	9.895	9.895	10.195	6,5	11
MS_5RP	Two-seater right end element with piping and lacquered base	6.000	6.375	6.675	7.340	7.945	9.440	9.440	9.885	6,5	11
MS_5RCP	Two-seater right end element with piping and chromed base	6.905	7.200	7.655	8.240	8.775	9.895	9.895	10.195	6,5	11

Cap Martin Sunset

design: Carlo Colombo 2019

Code description

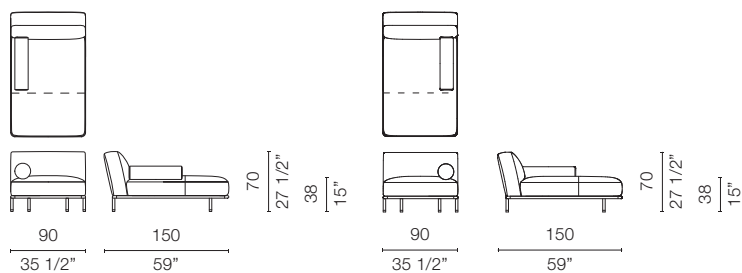

		cat. A	cat. B	cat. C	cat. D	cat. E	cat. E1	cat. G	cat. G2	fabric lmt	leather sqmt
MS_6L	Left chaise longue with lacquered base	4.115	4.355	4.560	5.000	5.440	6.610	6.610	6.855	4,5	8
MS_6LC	Left chaise longue with chromed base	4.790	5.090	5.310	5.820	6.190	6.990	6.990	7.225	4,5	8
MS_6R	Right chaise longue with lacquered base	4.115	4.355	4.560	5.000	5.440	6.610	6.610	6.855	4,5	8
MS_6RC	Right chaise longue with chromed base	4.790	5.090	5.310	5.820	6.190	6.990	6.990	7.225	4,5	8

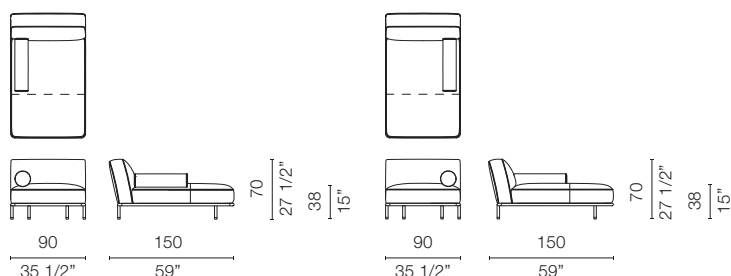

		cat. A	cat. B	cat. C	cat. D	cat. E	cat. E1	cat. G	cat. G2	fabric lmt	leather sqmt
MS_6LP	Left chaise longue with piping and lacquered base	4.490	4.735	4.935	5.390	5.845	7.045	7.045	7.280	4,5	8
MS_6LCP	Left chaise longue with piping and chromed base	5.185	5.480	5.705	6.230	6.600	7.435	7.435	7.655	4,5	8
MS_6RP	Right chaise longue with piping and lacquered base	4.490	4.735	4.935	5.390	5.845	7.045	7.045	7.280	4,5	8
MS_6RCP	Right chaise longue with piping and chromed base	5.185	5.480	5.705	6.230	6.600	7.435	7.435	7.655	4,5	8

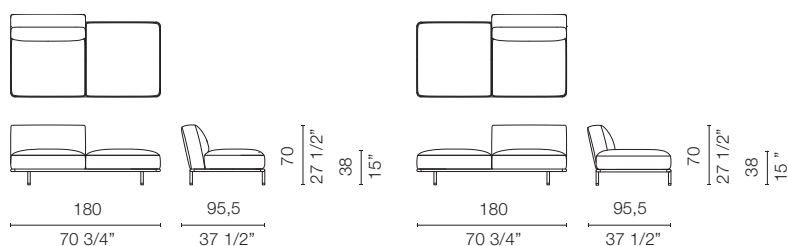

		cat. A	cat. B	cat. C	cat. D	cat. E	cat. E1	cat. G	cat. G2	fabric lmt	leather sqmt
MS_6OL	Two-seater left chaise longue with lacquered base	5.525	5.785	6.125	6.715	7.230	8.605	8.605	8.880	5,5	8
MS_6OLC	Two-seater left chaise longue with chromed base	5.665	6.730	7.075	7.675	8.280	9.045	9.045	9.335	5,5	8
MS_6OR	Two-seater right chaise longue with lacquered base	5.525	5.785	6.125	6.715	7.230	8.605	8.605	8.880	5,5	8
MS_6ORC	Two-seater right chaise longue with chromed base	5.665	6.730	7.075	7.675	8.280	9.045	9.045	9.335	5,5	8

Cap Martin Sunset

design: Carlo Colombo 2019

Code description

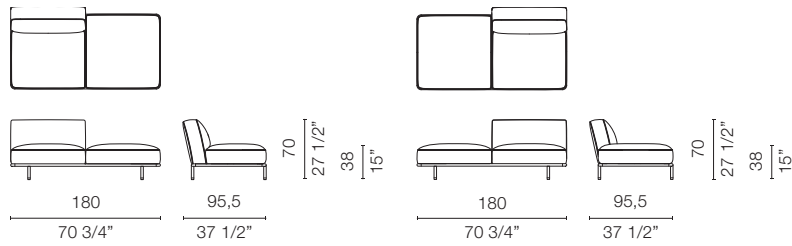

		cat. A	cat. B	cat. C	cat. D	cat. E	cat. E1	cat. G	cat. G2	fabric lmt	leather sqmt
MS_60LP	Two-seater left chaise longue with piping and lacquered base	6.305	6.585	6.940	7.525	8.055	9.460	9.460	9.735	5,5	8
MS_60LCP	Two-seater left chaise longue with piping and chromed base	6.485	7.545	7.895	8.515	9.135	9.910	9.910	10.210	5,5	8
MS_60RP	Two-seater right chaise longue with piping and lacquered base	6.305	6.585	6.940	7.525	8.055	9.460	9.460	9.735	5,5	8
MS_60RCP	Two-seater right chaise longue with piping and chromed base	6.365	7.420	7.760	8.365	8.970	9.735	9.735	10.030	5,5	8

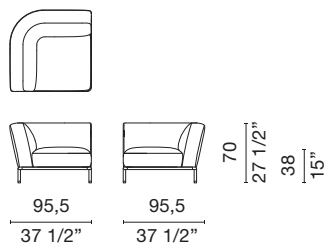

		cat. A	cat. B	cat. C	cat. D	cat. E	cat. E1	cat. G	cat. G2	fabric lmt	leather sqmt
MS_7	Corner element with lacquered base	4.425	4.655	4.865	5.310	5.665	6.710	6.710	6.925	4	7
MS_7C	Corner element with chromed base	5.165	5.455	5.665	6.115	6.485	6.990	6.990	7.320	4	7

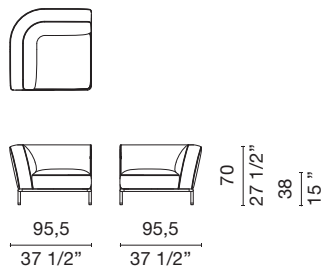

		cat. A	cat. B	cat. C	cat. D	cat. E	cat. E1	cat. G	cat. G2	fabric lmt	leather sqmt
MS_7P	Corner element with piping and lacquered base	4.735	4.955	5.185	5.620	6.000	7.055	7.055	7.280	4	7
MS_7CP	Corner element with piping and chromed base	5.480	5.775	6.000	6.450	6.825	7.350	7.350	7.675	4	7

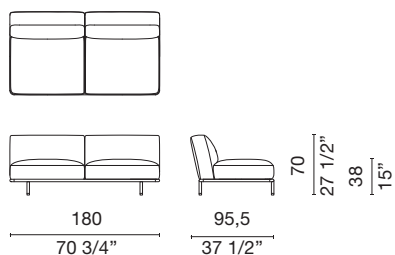

		cat. A	cat. B	cat. C	cat. D	cat. E	cat. E1	cat. G	cat. G2	fabric lmt	leather sqmt
MS_8	Two-seater central element with lacquered base	4.940	5.235	5.530	6.040	6.625	8.030	8.030	8.395	6	10
MS_8C	Two-seater central element with chromed base	5.745	6.040	6.410	7.145	7.495	8.395	8.395	8.730	6	10

Cap Martin Sunset

design: Carlo Colombo 2019

Code description

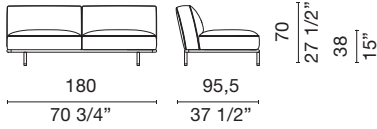
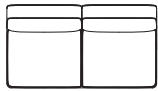

		cat. A	cat. B	cat. C	cat. D	cat. E	cat. E1	cat. G	cat. G2	fabric lmt	leather sqmt
MS_8P	Two-seater central element with piping and lacquered base	5.620	5.930	6.230	6.750	7.350	8.775	8.775	9.150	6	10
MS_8CP	Two-seater central element with piping and chromed base	6.450	6.750	7.125	7.870	8.230	9.150	9.150	9.500	6	10

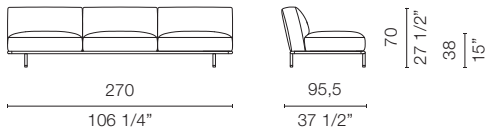
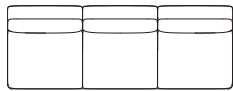

		cat. A	cat. B	cat. C	cat. D	cat. E	cat. E1	cat. G	cat. G2	fabric lmt	leather sqmt
MS_14	Three-seater central element with lacquered base	6.610	7.060	7.595	8.395	9.120	11.330	11.330	11.555	8,2	14,2
MS_14C	Three-seater central element with chromed base	7.735	8.170	8.685	9.570	10.380	11.775	11.775	11.920	8,2	14,2

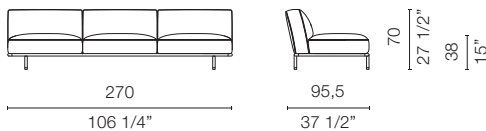
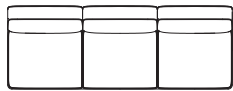

		cat. A	cat. B	cat. C	cat. D	cat. E	cat. E1	cat. G	cat. G2	fabric lmt	leather sqmt
MS_14P	Three-seater central element with piping and lacquered base	7.630	8.085	8.620	9.440	10.180	12.435	12.435	12.660	8,2	14,2
MS_14CP	Three-seater central element with piping and chromed base	8.775	9.220	9.740	10.650	11.465	12.895	12.895	13.035	8,2	14,2

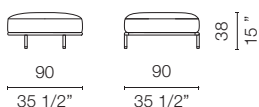

		cat. A	cat. B	cat. C	cat. D	cat. E	cat. E1	cat. G	cat. G2	fabric lmt	leather sqmt
MS_1	Pouf with lacquered base	2.060	2.155	2.300	2.440	2.665	3.105	3.105	3.240	2	3,5
MS_1C	Pouf with chromed base	2.590	2.730	2.805	3.025	3.175	3.540	3.540	3.685	2	3,5

Cap Martin Sunset

design: Carlo Colombo 2019

Code description

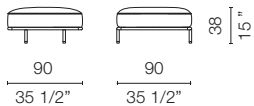

		cat. A	cat. B	cat. C	cat. D	cat. E	cat. E1	cat. G	cat. G2	fabric lmt	leather sqmt
MS_1P	Pouf with piping and lacquered base	2.175	2.260	2.415	2.565	2.785	3.235	3.235	3.365	2	3,5
MS_1CP	Pouf with piping and chromed base	2.710	2.860	2.940	3.160	3.310	3.685	3.685	3.835	2	3,5

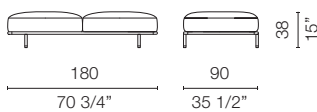

		cat. A	cat. B	cat. C	cat. D	cat. E	cat. E1	cat. G	cat. G2	fabric lmt	leather sqmt
MS_9	Two-seater pouf with lacquered base	3.675	3.830	4.055	4.425	4.790	5.600	5.600	5.820	4	6,5
MS_9C	Two-seater pouf with chromed base	4.310	4.500	4.790	5.165	5.530	5.965	5.965	6.115	4	6,5

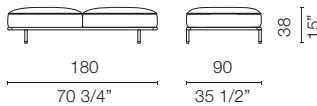

		cat. A	cat. B	cat. C	cat. D	cat. E	cat. E1	cat. G	cat. G2	fabric lmt	leather sqmt
MS_9P	Two-seater pouf with piping and lacquered base	3.920	4.075	4.315	4.690	5.065	5.890	5.890	6.120	4	6,5
MS_9CP	Two-seater pouf with piping and chromed base	4.585	4.765	5.065	5.440	5.810	6.270	6.270	6.415	4	6,5

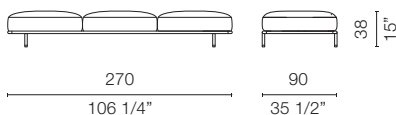
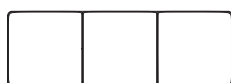

		cat. A	cat. B	cat. C	cat. D	cat. E	cat. E1	cat. G	cat. G2	fabric lmt	leather sqmt
MS_10	Three-seater pouf with lacquered base	5.000	5.310	5.585	6.030	6.475	7.515	7.515	7.785	5	8
MS_10C	Three-seater pouf with chromed base	5.745	6.040	6.335	6.915	7.360	7.885	7.885	8.170	5	8

Cap Martin Sunset

design: Carlo Colombo 2019

Code description

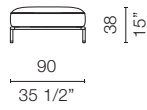
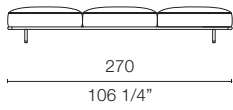
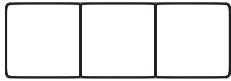

		cat. A	cat. B	cat. C	cat. D	cat. E	cat. E1	cat. G	cat. G2	fabric lmt	leather sqmt
MS_10P	Three-seater pouf with piping and lacquered base	5.460	5.775	6.065	6.510	6.965	8.025	8.025	8.300	5	8
MS_10CP	Three-seater pouf with piping and chromed base	6.230	6.520	6.825	7.420	7.870	8.395	8.395	8.690	5	8

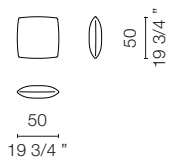

		cat. A	cat. B	cat. C	cat. D	cat. E	cat. E1	cat. G	cat. G2	fabric lmt	leather sqmt
MS_50	Cushion - feather	280	295	305	350	390	500	530	585	1	2
MS_50P	Cushion with piping - feather	350	365	390	420	450	570	615	675	1	2

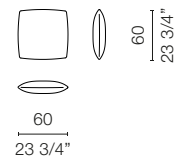

		cat. A	cat. B	cat. C	cat. D	cat. E	cat. E1	cat. G	cat. G2	fabric lmt	leather sqmt
MS_60	Cushion - feather	305	325	335	390	420	545	605	645	1	2
MS_60P	Cushion with piping - feather	390	395	415	450	485	625	695	710	1	2

Armchair and footrest with metal base and fixed upholstery in fabrics and leathers from the collection, which can cover the whole structure or be combined for the front and the back.



Base

metal tube

Base finish

matt varnished
01 white
04 black
71 mud
404 terracotta

Structure

co-injection of resin and polyurethane foam

Cover

fixed in fabric and leather
for front and back in different fabrics = highest category price to be calculated
for front in fabric and back in leather = highest category price to be calculated

Feet

loose in natural nylon

Greenguard

Capo has been certified with Greenguard Gold

	A	A _o	B	B _o	C				D			E				E ₁	G	G ₂	V	
Phill																				
Trame																				
Vancouver																				
Sorrento																				
Sorrento rigato																				
Ecopelle																				
Trentino Stretto																				
Vancouver																				
Ambro																				
Blelastico Color																				
Blelastico Optical																				
Brecon																				
Corda																				
Madrid																				
Oceanic																				
Vancouver																				
Baltimore Plus Eco																				
Hallingdal 2																				
Panno																				
Steelcut Trio																				
Deft Velvet																				
Dimmore Plaid																				
Hardwick Plaid																				
Hero 2																				
Ivyside Herringbone																				
Market Street Plaid																				
Veronmet																				
Zero																				
Chandigar																				
Pelle																				
Pelle Extra																				
Spotted leather																				
Artemidor																				
Pucci Cotton / Velvet																				
Hilde																				

Code description

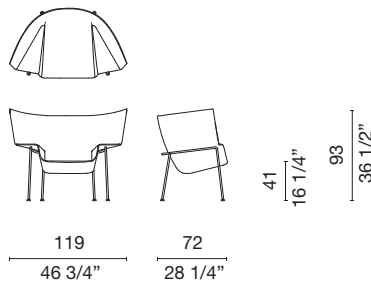

		cat. A	cat. B	cat. C	cat. D	cat. E	cat. G	cat. G2	fabric lmt	leather sqmt
CP_1	Armchair	4.865	5.005	5.075	5.445	6.140	6.490	6.585	5,5	7,15

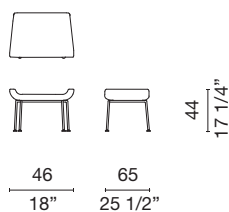

		cat. A	cat. B	cat. C	cat. D	cat. E	cat. G	cat. G2	fabric lmt	leather sqmt
CP_2	Footrest	1.395	1.450	1.485	1.510	1.675	1.540	1.690	1,1	0,88

Modular seating system of different dimensions to create various types of configurations. Padding in polyurethane foam and cushions in feathers (or in polyurethane foam upon request) with removable cover in fabric or leather.



Structure

wooden conglomerate panels, solid fir, poplar plywood, metal frame

Padding

multi-density polyurethane foam and fibre

Seat cushion

feather

Feet

black plastic Ø mm 60 x h 40

Cover

removable in fabric and leather
upon request, the upholstery for each item can be ordered separately

Loose cushions

useful as a completion
made in foam and leather, available in both the same colour and material of the requested cover (CU_25 dim. cm.60x60x8)

Notes

Note 1

All covers in leather have contrasting seams in rope colour

Note 2

Upon request, the seating elements are also available with cushions in polyurethane foam and fibre, with the following codes:

CUE1 - CUE2 - CUE4 - CUE41 - CUE5 - CUE51 - CUE22 - CUE23 - CUE24 - CUE25 - CUE254 - CUE255 - CUE30 - CUE253 - CUE32 - CUE256 - CUE37 - CUE38

A	A ₀	B	B ₀	C	D	E	E ₁	G	G ₂	V
Phill										
Trame										
Vancouver										
Sorrento										
Sorrento rigato										
Ecopelle										
Trentino Stretto										
Vancouver										
Ambro										
Bialastico Color										
Bialastico Optical										
Brecon										
Corda										
Madrid										
Oceanic										
Vancouver										
Baltimore Plus Eco										
Hallingdal 2										
Panno										
Steelcut Trio										
Delft Velvet										
Dunmore Plaid										
Hardwick Plaid										
Hero 2										
Iyaside Herringbone										
Market Street Plaid										
Veronnet										
Zero										
Chandigar										
Pelle										
Pelle Extra										
Spotted leather										
Artemidor										
Pucci Cotton / Velvet										
Hide										

Code description

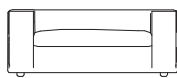
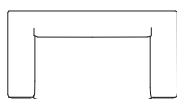

40
15 3/4"
62
24 1/2"

170
67"

85
33 1/2"

		cat. A	cat. B	cat. C	cat. D	cat. E	cat. E1	cat. G	cat. G2	fabric lmt	leather sqmt
CUS1	Two-seater sofa	5.025	5.160	5.410	5.980	6.765	8.195	7.450	7.860	6,6	12,65

Code description

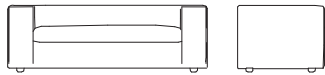
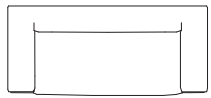

40
15 3/4" 62
24 1/2"

200 85
78 3/4" 33 1/2"

		cat. A	cat. B	cat. C	cat. D	cat. E	cat. E1	cat. G	cat. G2	fabric lmt	leather sqmt
CUS2	Two-seater wide sofa	5.400	6.015	6.410	7.260	8.370	10.485	9.570	10.230	7,7	14,85

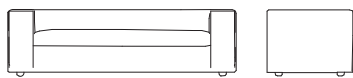

40
15 3/4" 62
24 1/2"

230 85
90 1/2" 33 1/2"

		cat. A	cat. B	cat. C	cat. D	cat. E	cat. E1	cat. G	cat. G2	fabric lmt	leather sqmt
CUS4	Three-seater sofa	6.240	6.720	7.445	7.950	9.115	11.355	10.345	11.020	8	16,5

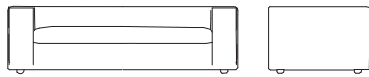
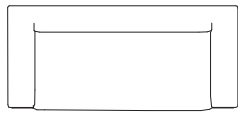

40
15 3/4" 62
24 1/2"

230 100
90 1/2" 39 1/4"

		cat. A	cat. B	cat. C	cat. D	cat. E	cat. E1	cat. G	cat. G2	fabric lmt	leather sqmt
CUS41	Three-seater sofa	7.055	7.270	7.545	8.495	8.870	10.975	10.690	11.215	8,2	14

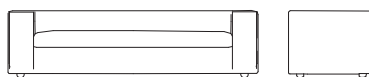
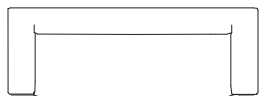

40
15 3/4" 62
24 1/2"

250 85
98 1/2" 33 1/2"

		cat. A	cat. B	cat. C	cat. D	cat. E	cat. E1	cat. G	cat. G2	fabric lmt	leather sqmt
CUS5	Three-seater wide sofa	6.665	7.155	7.525	8.410	9.595	11.865	10.760	11.500	9,9	18,7

Code description

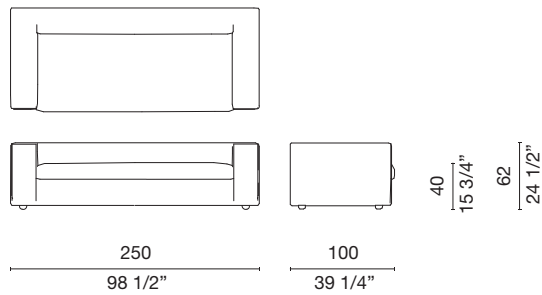

		cat. A	cat. B	cat. C	cat. D	cat. E	cat. E1	cat. G	cat. G2	fabric lmt	leather sqmt
CUS51	Three-seater wide sofa	7.350	7.600	7.925	8.990	9.400	11.725	11.360	11.945	8,9	15

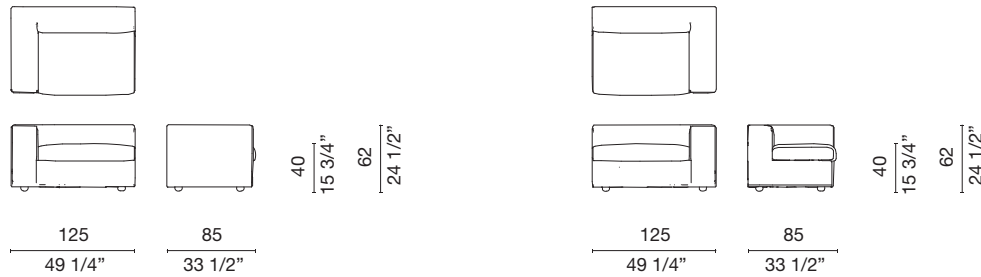

		cat. A	cat. B	cat. C	cat. D	cat. E	cat. E1	cat. G	cat. G2	fabric lmt	leather sqmt
CUS22	Left end element	3.715	3.955	4.150	4.680	5.315	6.550	6.040	6.505	5,5	10,45
CUS23	Right end element	3.715	3.955	4.150	4.680	5.315	6.550	6.040	6.505	5,5	10,45

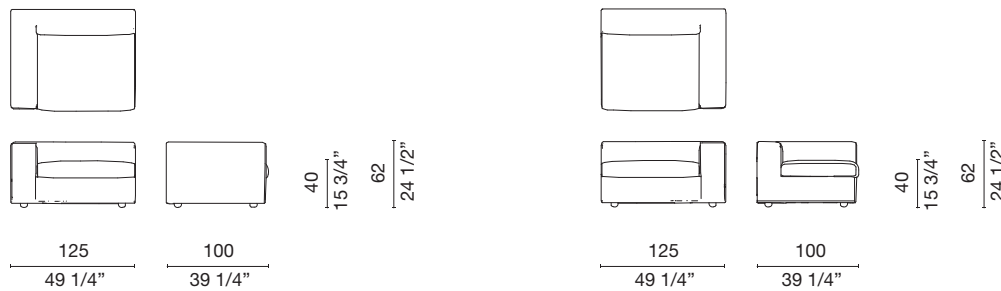

		cat. A	cat. B	cat. C	cat. D	cat. E	cat. E1	cat. G	cat. G2	fabric lmt	leather sqmt
CUS24	Left end element	4.285	4.425	4.635	5.260	5.530	6.910	6.605	6.975	5,72	9,9
CUS25	Right end element	4.285	4.425	4.635	5.260	5.530	6.910	6.605	6.975	5,72	9,9

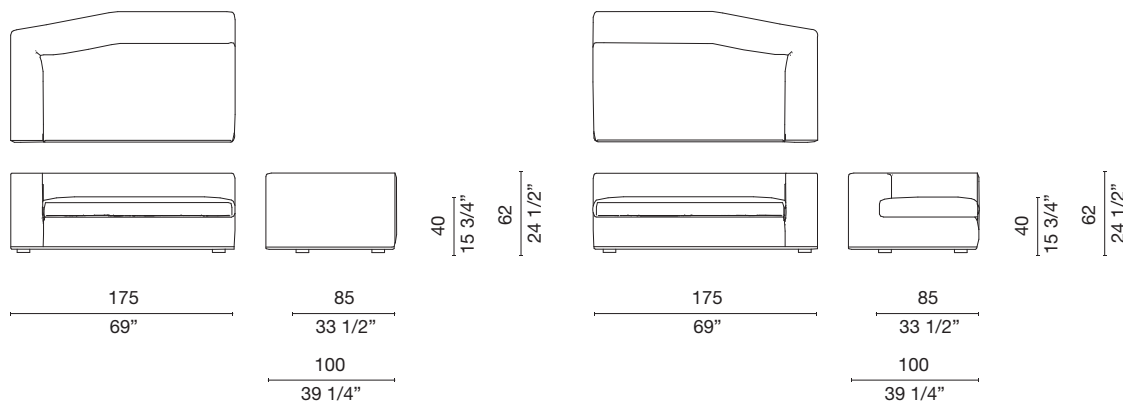

		cat. A	cat. B	cat. C	cat. D	cat. E	cat. E1	cat. G	cat. G2	fabric lmt	leather sqmt
CU_254	Asymmetrical left end element	5.315	5.730	6.110	6.895	7.940	9.940	9.080	9.750	8,8	15,4
CU_255	Righ asymmetrical end element	5.315	5.730	6.110	6.895	7.940	9.940	9.080	9.750	8,8	15,4

Code description



40
15 3/4" 62
24 1/2"

85
33 1/2"

85
33 1/2"

	cat. A	cat. B	cat. C	cat. D	cat. E	cat. E1	cat. G	cat. G2	fabric lmt	leather sqmt
CUS30 Corner element	3.245	3.425	3.570	3.935	4.380	5.275	4.910	5.160	4,4	8,36

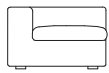
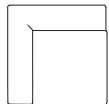

40
15 3/4" 62
24 1/2"

100
39 1/4"

100
39 1/4"

	cat. A	cat. B	cat. C	cat. D	cat. E	cat. E1	cat. G	cat. G2	fabric lmt	leather sqmt
CU_253 Corner element	3.370	3.670	3.890	4.400	5.055	6.315	5.790	6.195	5,28	8,8

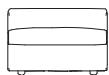
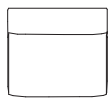

40
15 3/4" 62
24 1/2"

100
39 1/4"

85
33 1/2"

	cat. A	cat. B	cat. C	cat. D	cat. E	cat. E1	cat. G	cat. G2	fabric lmt	leather sqmt
CUS32 Central element	3.015	3.190	3.320	3.820	4.135	5.055	4.470	4.775	4,73	9,57

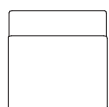

40
15 3/4" 62
24 1/2"

100
39 1/4"

100
39 1/4"

	cat. A	cat. B	cat. C	cat. D	cat. E	cat. E1	cat. G	cat. G2	fabric lmt	leather sqmt
CU_256 Central element	2.795	3.015	3.200	3.620	4.150	5.195	4.770	5.080	4,62	7,48

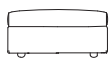

40
15 3/4"

100
39 1/4"

85
33 1/2"

	cat. A	cat. B	cat. C	cat. D	cat. E	cat. E1	cat. G	cat. G2	fabric lmt	leather sqmt
CUS37 Pouf	2.905	3.080	3.245	3.605	4.090	4.970	4.840	5.105	4,4	8,36

Code description

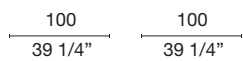
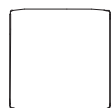

		cat. A	cat. B	cat. C	cat. D	cat. E	cat. E1	cat. G	cat. G2	fabric lmt	leather sqmt
CUS38	Pouf	2.780	2.905	3.045	3.580	3.765	4.950	5.020	5.315	4,3	7,5

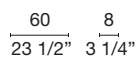

		cat. A	cat. B	cat. C	cat. D	cat. E	cat. E1	cat. G	cat. G2	fabric lmt	leather sqmt
CU_25	Cushion	490	545	600	710	825	1.080	910	980	1,54	2,2

Sofa-bed in different dimensions with padding in polyurethane foam and cushions in feather (or in polyurethane foam upon request); removable cover in fabric or leather.



Structure

wooden conglomerate panels, solid fir, poplar plywood, metal frame

Padding

multi-density polyurethane foam and fibre

Seat cushion

feather

Cover

removable in fabric and leather upon request, the upholstery for each item can be ordered separately

Loose cushions

useful as a completion made in foam and leather, available in both the same colour and material of the requested cover (CU_25 dim. cm.60x60x8)

Feet

black plastic Ø mm 60 x h 40

Mattresses for beds

french size cm 132x180x7 (CUS10)
double bed cm. 152x180x7 (CUS13)

mattresses are in poliurethane foam and have a tolerance in lenght around - 4%

Bedstead

ash plywood slats

Notes

Note 1

All covers in leather have contrasting seams in rope colour

Note 2

Upon request, the seating elements are also available with cushions in polyurethane foam and fibre, with the following codes: CUE10 - CUE13

Phill	A	A ₀	B	B ₀	C	D	E	E ₁	G	G ₂	V																							
•	Trame	Vancouver	Sorrento	Sorrento rigato	Ecopelle	Trentino Stretto	Vancouver	Ambro	Bielastico Color	Bielastico Optical	Brecon	Corda	Madrid	Oceanic	Vancouver	Baltimore Plus Eco	Hallingdal 2	Panno	Steelcut Trio	Delft Velvet	Dunmore Plaid	Hardwick Plaid	Hero 2	Ivyside Herringbone	Market Street Plaid	Verommet	Zero	Chandigar	Pelle	Pelle Extra	Spotted leather	Artemidor	Pucci Cotton / Velvet	Hide

Code description

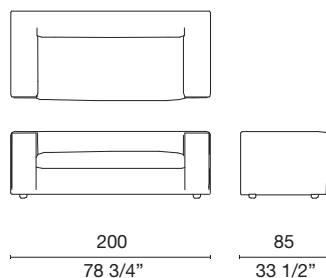

		cat. A	cat. B	cat. C	cat. D	cat. E	cat. E1	cat. G	cat. G2	fabric lmt	leather sqmt
CUS10	Two-seater wide sofa with French size bed	6.025	6.425	6.745	7.525	8.550	10.520	9.685	10.280	7,7	14,85

Cuba 25 Sofa-Bed

design: Rodolfo Dordoni 2013

Code description

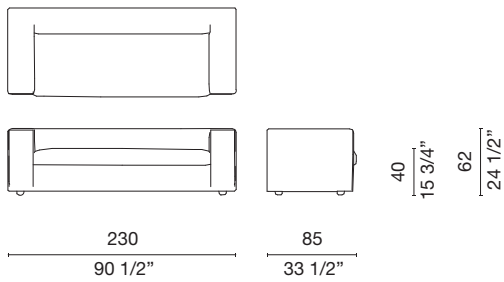

	cat. A	cat. B	cat. C	cat. D	cat. E	cat. E1	cat. G	cat. G2	fabric lmt	leather sqmt
CUS13 Three-seater sofa with double bed	6.470	6.975	7.275	8.075	9.095	11.110	10.205	10.825	8,8	17,6

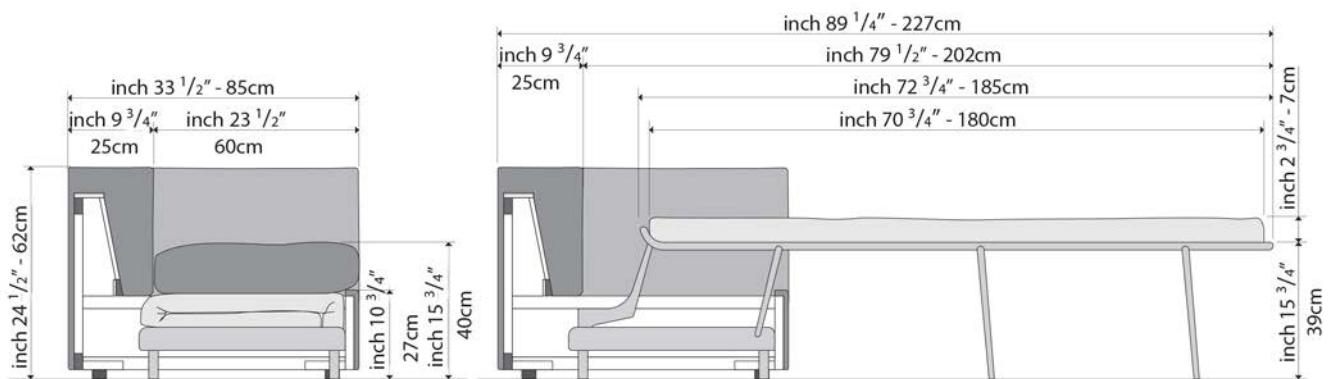

Padded armchair with swivel metal base, also available with return mechanism, and fixed cover in a wide selection of fabrics and leather of the collection.



Structure

seat in glass fibre and resin

Padding

polyurethane foam

Seat structure

polyurethane foam with poplar plywood frame with elastic belts

Seat cover

fixed in fabric and leather

Base

steel swivel base with spring return mechanism
steel swivel base without spring return mechanism

Base finish

powder varnished natural aluminium colour

Feet

felt pads

Notes

Note 1

Removable cushion for base adjustment

Note 2

Free fabric and leather matching for seat and backrest not available

Greenguard

Dalia has been certified with Greenguard Gold

	A	A ₀	B	B ₀	C	D	E	E ₁	G	G ₂	V
●	Phill										
●	Triame										
	Vancouver										
	Sorrento										
	Sorrento rigato										
●	Ecopelle										
●	Trentino Stretto										
●	Vancouver										
	Ambro										
	Bielastico Color										
	Bielastico Optical										
●	Brecon										
	Corca										
●	Madrid										
●	Oceanic										
●	Vancouver										
	Baltimore Plus Eco										
●	Hallingdal 2										
●	Panno										
	Steelcut Trio										
●	Delft Velvet										
●	Dunmore Plaid										
●	Hardwick Plaid										
●	Hero 2										
●	Ivyside Herringbone										
●	Market Street Plaid										
	Veronnet										
●	Zero										
●	Chandigar										
●	Pelle										
●	Pelle Extra										
	Spotted leather										
	Artemidor										
	Pucci Cotton / Velvet										
	Hide										

Code description



74
29 1/4"

86
33 3/4"

83
32 3/4"

		cat. A	cat. B	cat. C	cat. D	cat. E	cat. E1	cat. G	cat. G2	fabric lmt	leather sqmt
DL_1	Armchair without spring return mechanism	4.240	4.370	4.425	4.680	5.105	5.435	6.355	6.440	3,63	6,05



74
29 1/4"

86
33 3/4"

83
32 3/4"

		cat. A	cat. B	cat. C	cat. D	cat. E	cat. E1	cat. G	cat. G2	fabric lmt	leather sqmt
DL_1R	Armchair with spring return mechanism	4.460	4.565	4.650	4.900	5.310	5.660	6.600	6.665	3,63	6,05

Sofa and méridienne with legs in die-cast aluminium, polyurethane foam padding and fixed upholstery in a selection of fabrics and leathers of the collection.



Structure

solid fir, poplar plywood, birch plywood and metal fixing plates

Padding

multi-density polyurethane foam and polyester fibre

Cover

fixed in fabric and leather

Base

polish natural die-cast aluminium

Feet

black plastic

Notes

Note 1

Tone on tone stitchings

Note 2

The roller cushion of the sofa is shorter than the roller cushion of the méridienne

A		A _o	B		B _o	C				D			E				E ₁	G	G ₂	V														
Phill	Trame	Vancouver	Sorrento	Sorrento rigato	Ecopelle	Trentino Stretto	Vancouver	Ambro	Blelastico Color	Blelastico Optical	Breson	Conda	Madrid	Oceanic	Vancouver	Baltimore Plus Eco	Hallingdal 2	Parno	Steelcut Trio	Deift Velvet	Dimmore Plaid	Hardwick Plaid	Hero 2	Ivyside Herringbone	Marker Street Plaid	Veronmet	Zero	Chandigar	Pelle	Pelle Extra	Spotted leather	Artemidor	Pucci Cotton/Velvet	Hilde
•	•	•			•	•	•				•	•	•	•	•	•	•	•	•	•	•	•	•	•	•	•			•	•				

Code description

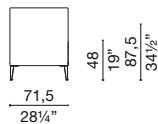
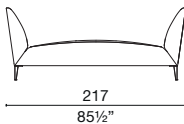

		cat. A	cat. B	cat. C	cat. D	cat. E	cat. G	cat. G ₂	fabric lmt	leather sqmt
DB_1	Méridienne	3.760	4.295	4.610	4.955	5.345	5.960	6.270	5	9

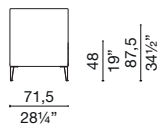
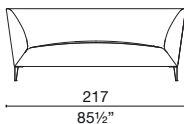
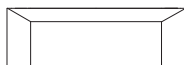

		cat. A	cat. B	cat. C	cat. D	cat. E	cat. G	cat. G ₂	fabric lmt	leather sqmt
DB_2	Sofa	5.500	6.300	6.840	7.365	7.905	8.845	9.245	7,5	13,5

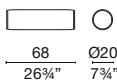

		cat. A	cat. B	cat. C	cat. D	cat. E	cat. G	cat. G ₂	fabric lmt	leather sqmt
DB_68	Roller cushion for méridienne	365	455	500	530	605	680	740	0,8	1,5

Code description

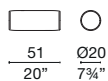

		cat. A	cat. B	cat. C	cat. D	cat. E	cat. G	cat. G2	fabric lmt	leather sqmt
DB_51	Roller cushion for sofa	335	430	455	500	545	630	670	0,7	1,3

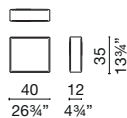

		cat. A	cat. B	cat. C	cat. D	cat. E	cat. G	cat. G2	fabric lmt	leather sqmt
DB_40	Square cushion	285	345	375	420	455	530	580	0,6	1,1

Series of armchairs and poufs that can be combined to create modular compositions with different shapes and dimensions. Fixed upholstery in fabrics and leathers from the collection, also mixing different colours and materials.



Armchair structure

foamed polyurethane with metallic insert and elastic belts

Pouf structure

rigid composite polyurethane with poplar plywood inserts

Small pouf structure

polyurethane foam with polystyrene insert, poplar plywood and MDF

Base

medium-density wooden fiber conglomerate panel
matt lacquered 04 black

Padding

polyurethane foam

Cover

fixed monocolour in bielastico color and bielastico optical fabric
fixed monocolour or bicolour in a selection of fabrics and leathers of the collection
fixed bicolour in bielastico color fabric and black leather

Feet

felt pads

Notes

Nota 1

In the bicolour version of the armchair and pouf, different colours of the same fabric or leather can be combined

Nota 2

Colour on colour thread

For textured fabrics, thread in the darker shade of the fabric

Nota 3

The mono-colour armchairs have two zippers at the sides in beige colour for lighter-coloured covers and anthracite for dark colours

The bicolour armchair has two zippers at the sides, beige for lighter-coloured front seat covers and anthracite for dark seat covers

Note 4

The cover of the small armchair DRU6 is not available in bielastico optical fabric (cat. C) and in the bicolour version

Note 5

Armchair, pouf and small pouf available with fixed base

Small armchair available with fixed, swivel or swivel with return mechanism base

	A	A ₀		B	B ₀		C		D		E	E ₁	G	G ₂	V	
Phill																
Trame																
Vancouver																
Sorrento																
Sorrento rigato																
Ecopelle				•												
Trentino Stretto																
Vancouver					•											
Ambro																
Bielastico Color																
Bielastico Optical																
O																
Brecon																
Corda																
Madrid																
Oceanic																
Vancouver																
Baltimore Plus Eco																
Hallingdál 2																
Panno																
Steelcut Trio																
Delft Velvet																
Dunmore Plaid																
Hardwick Plaid																
Hero 2																
Ivyside Herringbone																
Market Street Plaid																
Veronnet																
Zero																
Chandigar																
Pelle																
Pelle Extra																
Spotted leather																
Artemidor																
Pucci Cotton / Velvet																
Hide																

Drum

design: Mac Stopa 2016

Code description

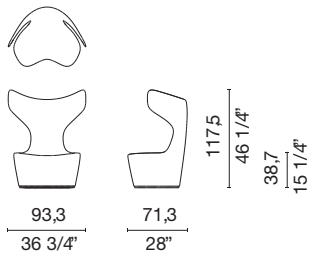

		cat. B	cat. C	cat. D	cat. E	cat. G	fabric lmt	leather sqmt
DRU6F	Armchair	4.080	4.310	4.820	5.245	5.385	3,45	5,7
DRU6	Swivel armchair	4.525	4.785	5.345	5.815	5.985	3,45	5,7
DRU6R	Swivel armchair with spring return mechanism	4.725	5.000	5.575	6.040	6.230	3,45	5,7

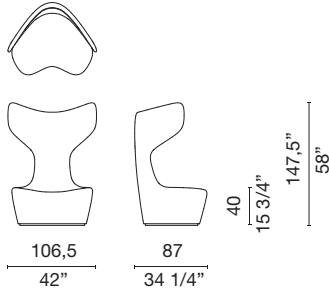

		cat. B	cat. C	cat. D	cat. E	cat. G	fabric lmt	leather sqmt
DRU1	Armchair in fabric or leather - mono/bicolour	5.175	5.590	5.990	6.515	6.560	7,5	9
DRU1B	Armchair in leather and Optical bi-elastic					5.850		
DRU1S	Armchair in Optical bi-elastic		5.590					

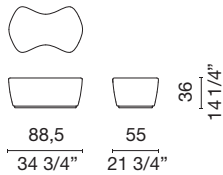

		cat. B	cat. C	cat. D	cat. E	cat. G	fabric lmt	leather sqmt
DRU2	Pouf in fabric or leather - mono/bicolour	2.490	2.605	2.635	2.730	2.930	1,5	2,8
DRU2B	Pouf in leather and bi-elastic Optical					2.845		
DRU2S	Pouf in Optical bi-elastic		2.605					

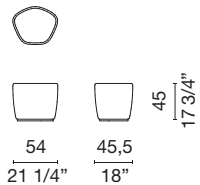

		cat. B	cat. C	cat. D	cat. E	cat. G	fabric lmt	leather sqmt
DRU5	Little pouf in fabric or leather - mono/bicolour	990	1.060	1.130	1.245	1.365	1,3	2,4
DRU5B	Little pouf in leather and Optical bi-elastic					1.315		
DRU5S	Little pouf in Optical bi-elastic		1.060					

DRU1 - DRU6F / DRU6 / DRU6R

Monocolour version in leather/fabric

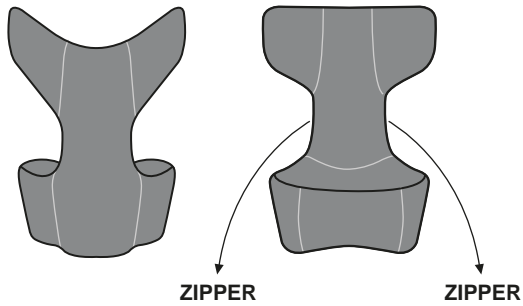

DRU1 - DRU6F / DRU6 / DRU6R

Monocolour version in bi-elastic Color fabric

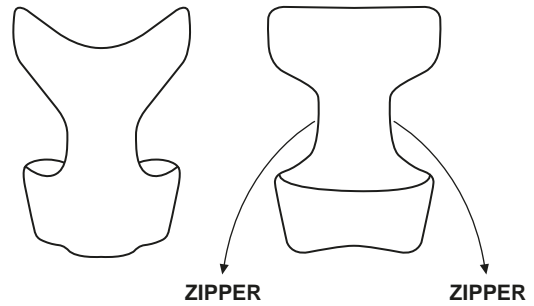

DRU1

Bicolour version in leather/fabric

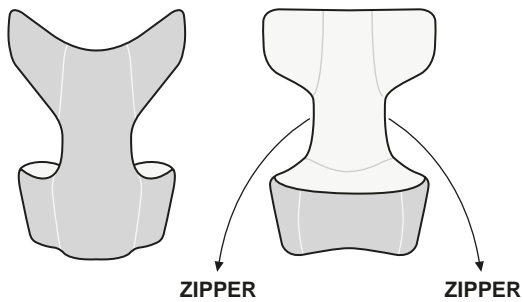

DRU1B

Bicolour version:
outside in black leather
inside in bi-elastic Optical fabric

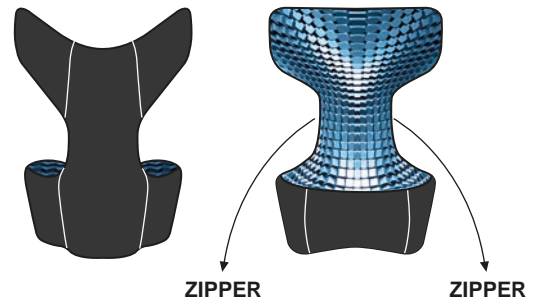

DRU1S

Monocolour version in bi-elastic Optical fabric

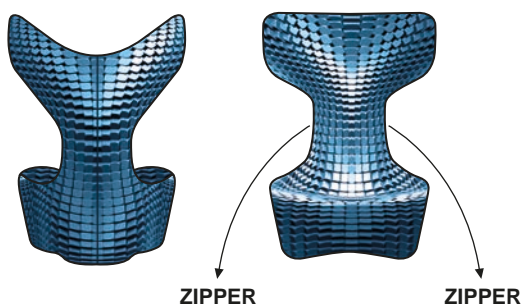

DRU2 - DRU5

Monocolour version in leather/fabric

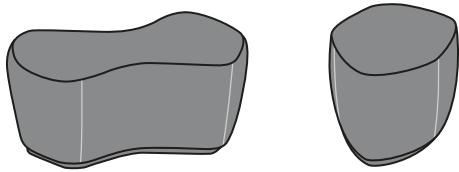

DRU2 - DRU5

Monocolour version in bi-elastic Color fabric

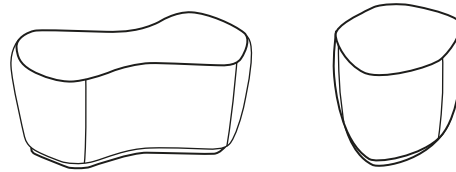

DRU2 - DRU5

Bicolour version in leather/fabric

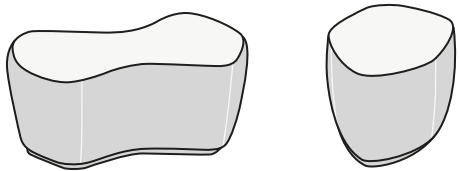

DRU2B - DRU5B

Bicolour version:
outside in black leather
inside in bi-elastic Optical fabric

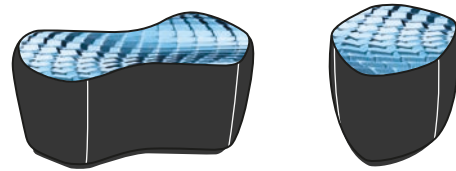

DRU2S - DRU5S

Monocolour version in bi-elastic Optical fabric

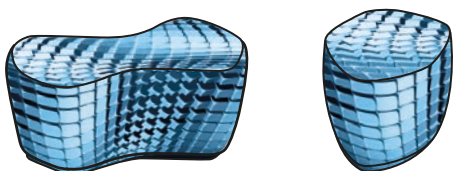

Collection of seating elements with stainless steel base and padding made of polyurethane foam with feather cushions in (polyurethane foam upon request). Removable cover in fabrics and leathers from the collection.



Structure

medium-density conglomerate wooden panels, solid fir, poplar plywood, metal frame

Springing system

elastic belts

Padding

multi-density polyurethane foam and feather

Cushions

feather
multi-density polyurethane foam and fibre

Feet

grey polyethylene on satined stainless steel and white lacquered base black polyethylene on black and mud lacquered base

Cover

removable in fabric and leather
upon request, the upholstery for each item can be ordered separately

Base finish

435 satined stainless steel

matt varnished
01 white
04 black
71 mud

Greenguard

Elan has been certified with Greenguard Gold

	A	A ₀	B	B ₀	C		D		E				E ₁	G	G ₂	V	
•	Phill																
•	Triame																
•	Vancouver																
	Sorrento																
	Sorrento rigato																
•	Ecopelle																
•	Trentino Stretto																
•	Vancouver																
	Ambro																
	Bielastico Color																
	Bielastico Optical																
	Brescon																
•	Corda																
•	Madrid																
•	Oceanic																
•	Vancouver																
•	Baltimore Plus Eco																
•	Hallingdal 2																
•	Panno																
•	Steelcut Trio																
•	Delft Velvet																
•	Dunmore Plaid																
•	Hardwick Plaid																
•	Hero 2																
•	Ivyside-Herringbone																
•	Market Street Plaid																
•	Veronnet																
•	Zero																
•	Chandigar																
•	Pelle																
•	Pelle Extra																
	Spotted leather																
	Artemidor																
	Pucci Cotton / Velvet																
	Hide																

Code description

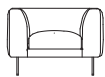
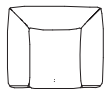

44
16 1/4"
69
26"

90
35 1/2"

82
32 1/4"

		cat. A	cat. B	cat. C	cat. D	cat. E	cat. E1	cat. G	cat. G2	fabric lmt	leather sqmt
EN_12	Armchair in feather	3.485	3.575	3.700	3.930	4.380	6.005	5.225	5.560	3,96	8,25
ENE12	Armchair in polyurethane foam	3.430	3.525	3.650	3.880	4.320	5.865	5.090	5.475	3,96	8,25

Code description

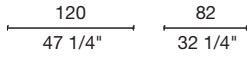
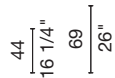
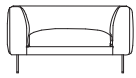
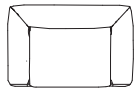

		cat. A	cat. B	cat. C	cat. D	cat. E	cat. E1	cat. G	cat. G2	fabric lmt	leather sqmt
EN_11	Armchair in feather	3.925	4.030	4.205	4.770	5.090	6.275	5.450	5.805	6	9,35
ENE11	Armchair in polyurethane foam	3.875	3.970	4.145	4.700	5.015	6.125	5.330	5.725	6	9,35

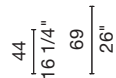
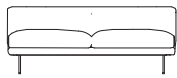
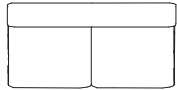

		cat. A	cat. B	cat. C	cat. D	cat. E	cat. E1	cat. G	cat. G2	fabric lmt	leather sqmt
EN_1	Element without armrests in feather	4.995	5.105	5.320	5.505	5.865	7.180	6.250	6.615	6,1	9,5
ENE1	Element without armrests in polyurethane foam	4.475	4.585	4.760	5.420	5.775	7.000	6.100	6.530	6,1	9,5

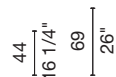
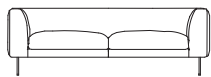
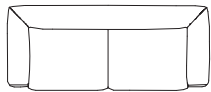

		cat. A	cat. B	cat. C	cat. D	cat. E	cat. E1	cat. G	cat. G2	fabric lmt	leather sqmt
EN_2	two-seater sofa in feather	5.290	5.550	5.790	6.395	7.315	9.860	8.565	9.150	9,35	17,05
ENE2	two-seater sofa in polyurethane foam	5.215	5.465	5.715	6.305	7.220	9.620	8.375	9.015	9,35	17,05

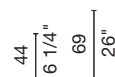
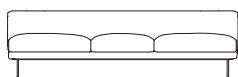
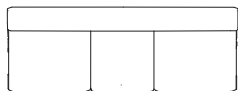

		cat. A	cat. B	cat. C	cat. D	cat. E	cat. E1	cat. G	cat. G2	fabric lmt	leather sqmt
EN_3	Element without armrests in feather	5.485	5.625	5.865	6.670	7.145	8.945	7.785	8.305	7,6	12,8
ENE3	Element without armrests in polyurethane foam	5.415	5.545	5.775	6.585	7.035	8.730	7.595	8.175	7,6	12,8

Code description

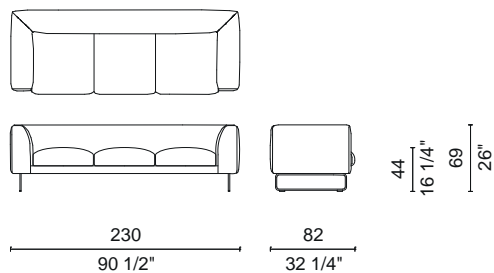

		cat. A	cat. B	cat. C	cat. D	cat. E	cat. E1	cat. G	cat. G2	fabric lmt	leather sqmt
EN_4	three-seater sofa in feather	5.980	6.220	6.475	7.070	7.965	10.940	9.515	10.140	8,8	17,05
ENE4	three-seater sofa in polyurethane foam	5.895	6.135	6.380	6.960	7.845	10.675	9.285	9.985	8,8	17,05

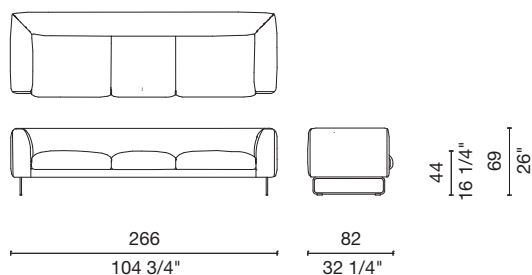

		cat. A	cat. B	cat. C	cat. D	cat. E	cat. E1	cat. G	cat. G2	fabric lmt	leather sqmt
EN_5	three-seater wide sofa in feather	6.465	6.770	7.070	7.755	8.880	11.950	10.390	10.885	11	19,03
ENES	three-seater wide sofa in polyurethane foam	6.375	6.670	6.960	7.655	8.765	11.645	10.125	10.720	11	19,03

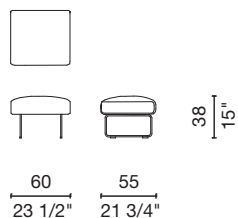

		cat. A	cat. B	cat. C	cat. D	cat. E	cat. E1	cat. G	cat. G2	fabric lmt	leather sqmt
EN_15	Pouf in feather	1.005	1.055	1.065	1.190	1.270	1.595	1.380	1.465	1	1,8
ENE15	Pouf in polyurethane foam	1.000	1.040	1.055	1.165	1.245	1.535	1.345	1.440	1	1,8

Modular seating system with pedestal MDF base and padding made of polyurethane foam. Removable cover in a selection of fabrics and leathers from the collection.



Structure

panels in wood particles, solid wood and fir plywood, metal frame

Suspension

elastic belts

Padding

multi-density polyurethan foam

Cushions

multi-density polyurethane foam and fibre

Feet

adjustable, black plastic

Cover

removable in fabric and leather upon request, the upholstery for each item can be ordered separately

Base finish

medium-density conglomerate wooden panels with black laminate finish

Note

Tone on tone stitching

	A	A ₀	B	B ₀	C		D		E				E ₁	G	G ₂	V
●	Phill															
●	Trame															
●	Vancouver															
●	Sorrento															
●	Sorrento rigato															
●	Ecopelle															
●	Trentino Stretto															
●	Vancouver															
●	Ambro															
●	Bielastico Color															
●	Bielastico Optical															
●	Brecon															
●	Corda															
●	Madrid															
●	Oceanic															
●	Vancouver															
●	Baltimora Plus Eco															
●	Hallingdal 2															
●	Panno															
●	Steelcut Trio															
●	Delft Velvet															
●	Dunmore Plaid															
●	Hardwick Plaid															
●	Hero 2															
●	Ivyside Herringbone															
●	Market Street Plaid															
●	Veronnet															
●	Zero															
●	Chandigar															
●	Pelle															
●	Pelle Extra															
●	Spotted leather															
●	Artemidor															
●	Pucci Cotton / Velvet															
●	Hide															

Code description

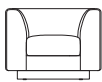
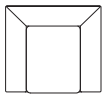

44
16 1/4"
69
26"

90
35 1/2"

82
32 1/4"

		cat. A	cat. B	cat. C	cat. D	cat. E	cat. E1	cat. G	cat. G2	fabric lmt	leather sqmt
EVE12	Armchair	3.470	3.620	3.740	3.990	4.215	6.070	5.175	5.460	4,4	9,9

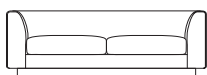
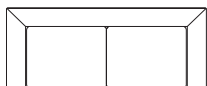

44
16 1/4"
69
26"

204
80 1/4"

82
32 1/4"

		cat. A	cat. B	cat. C	cat. D	cat. E	cat. E1	cat. G	cat. G2	fabric lmt	leather sqmt
EVE2	Two-seater sofa	5.380	5.905	6.260	6.860	7.445	10.010	8.400	8.905	9,35	18,7

Code description

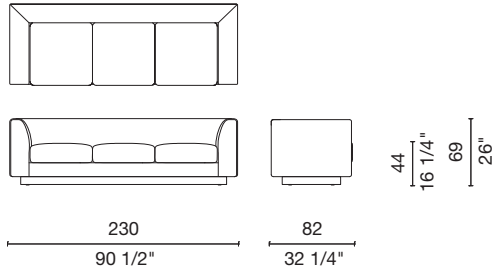

		cat. A	cat. B	cat. C	cat. D	cat. E	cat. E1	cat. G	cat. G2	fabric lmt	leather sqmt
EVE4	Three-seater sofa	5.820	6.390	6.775	7.420	8.045	10.805	9.060	9.610	9,9	18,7

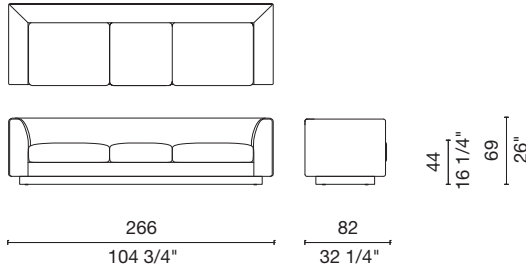

		cat. A	cat. B	cat. C	cat. D	cat. E	cat. E1	cat. G	cat. G2	fabric lmt	leather sqmt
EVE5	Large three-seater sofa	6.370	6.985	7.415	8.130	8.820	11.885	9.985	10.595	11,55	20,68

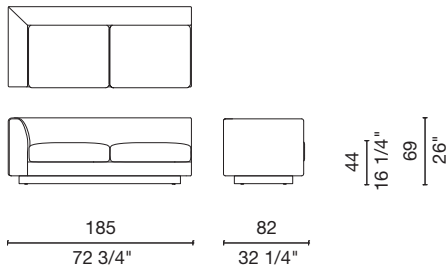

		cat. A	cat. B	cat. C	cat. D	cat. E	cat. E1	cat. G	cat. G2	fabric lmt	leather sqmt
EVE6	Terminal element with left armrest	5.250	5.755	6.095	6.670	7.240	9.690	8.145	8.630	8,8	14,52
EVE7	Terminal element with right armrest	5.250	5.755	6.095	6.670	7.240	9.690	8.145	8.630	8,8	14,52

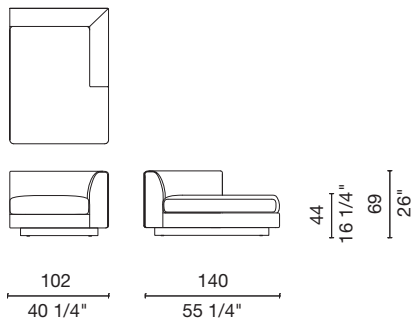

		cat. A	cat. B	cat. C	cat. D	cat. E	cat. E1	cat. G	cat. G2	fabric lmt	leather sqmt
EVE8L	Chaise longue with left armrest	4.785	5.240	5.545	6.055	6.545	8.700	7.395	7.815	8,8	18,15
EVE8R	Chaise longue with right armrest	4.785	5.240	5.545	6.055	6.545	8.700	7.395	7.815	8,8	18,15

Armchair in numbered edition available in four different versions, referring to the four seasons, with a fixed combination of the structure made of solid ash wood and the back with cross-stitch embroidery.



Structure

solid ash and back in poplar plywood with ash veneer

Back padding

polyurethane foam

Cover

fabric with woollen cross-stitch embroidery
in 4 design variants one for each season:

Spring
Summer
Autumn
Winter

Finish

fixed combinations of finishes on structure and embroidery on back

113 bleached ash: with Spring embroidery
A10 red aniline stained ash: with Summer embroidery
117 walnut stained ash: with Autumn embroidery
112 black-stained ash: with Winter embroidery

Feet

in black plastic

Note

Wood finish and back pattern combinations are standard

Code description



80
31 1/2"
37,5
14 3/4"

82
32 1/4"

63,5
25

Code	description	Price
EMB1	Armchair with cross-stitch upholstery - Winter	10.350
EMB2	Armchair with cross-stitch upholstery - Spring	10.350
EMB3	Armchair with cross-stitch upholstery - Summer	10.350
EMB4	Armchair with cross-stitch upholstery - Autumn	10.350

Embryo Chair

design: Marc Newson 1988

Armchair with three-leg chromed steel structure and padding made of polyurethane foam with fixed cover in bi-elastic fabric.



Structure

metal and plastic material

Padding

polyurethane foam

Base

chromed steel

Cover

fixed in bi-elastic color fabric cat. C

Feet

black rubber tips

Code description

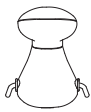

45
17 3/4" 80
31 1/2"

80
31 1/2"

85
33 1/2"

EC_1

Small armchair

Price

4.580

Armchair with structure made of polish varnished fiberglass and base made of polish aluminium.



Structure

reinforced fibreglass

Structure finish

polish varnished
 802 orange
 803 red
 805 blue
 806 white
 807 black

Base

polish natural aluminium

Note

Suitable for outdoor

Code	description
------	-------------



32.5
 12 3/4"
 82
 32 1/4"

67
 26 1/4"

106
 41 3/4"

Code	description	Price
FC_1L	Armchair	4.820

Armchair characterised by a great geometric rigour. Metal structure and polyurethane foam padding with removable cover in leather or ecoleather.



Structure

metal square section tube

Structure finish

matt varnished
01 white
04 black

Cushion padding

polyurethane foam

Cover

removable
cat. B = eco-leather white or black
cat. G = leather white or black

upon request, the upholstery for each item can be ordered separately

Springing system

covered tulipier slats

Feet

black rubber tips

Phill	A	A ₀	B	B ₀	C	D	E	E ₁	G	G ₀	V																								
	Trame	Vancouver	Sorrento	Sorrento rigato	Ecopelle	Trentino Stretto	Vancouver	Ambro	Bielastico Color	Bielastico Optical	Brecon	Corda	Madrid	Oceanic	Vancouver	Baltimore Plus Eco	Hallingdøl 2	Panno	Steelcut Trio	Delft Velvet	Dunmore Plaid	Hardwick Plaid	Hero 2	Iyaside Herringbone	Market Street Plaid	Veronnet	Zero	Chandigar	Pelle	Pelle Extra	Spotted leather	Artemidor	Pucci Cotton / Velvet	Hide	
					●																														

Code description

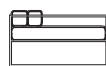
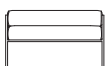

42
16 1/2"
62
24 1/2"

100
39 1/4"

100
39 1/4"

FR_41	Armchair	cat. B	cat. G	fabric lmt	leather sqmt
		2.970	4.030	12,54	6,82

Collection of seating elements with rounded backrest, aluminium feet and fixed cover in fabrics and leathers from the collection.



Structure

poplar plywood and solid fir

Padding

multi-density polyurethane foam

Feet

aluminium painted in matt black

Cover

fixed in fabric and leather

Resistance test

GAMBETTA collection has been tested following these regulations:

- EN 1728:2000- UNI EN 15373:2007 Level 3

Test copies available on request.

Fireproof test

UK CONTRACT and UK DOMESTIC: test copy available on request

Greenguard

Gambetta has been certified with Greenguard Gold

A	A ₀	B	B ₀	C	D	E	E ₁	G	G ₂	V
Phill										
Trame										
Vancouver										
Sorrento										
Sorrento rigato										
Ecopelle										
Trentino Stretto										
Vancouver										
Ambro										
Blelastico Color										
Blelastico Optical										
Brecon										
Conda										
Madrid										
Oceanic										
Vancouver										
Baltimore Plus Eco										
Hallingdal 2										
Panno										
Steelcut Trio										
Deift Velvet										
Dunmore Plaid										
Hardwick Plaid										
Hero 2										
Ivyside Herringbone										
Market Street Plaid										
Veronnet										
Zero										
Chandigar										
Pelle										
Pelle Extra										
Spotted leather										
Artemidor										
Pucci Cotton / Velvet										
Hilde										

Code description



42
16 1/2"
73
28 3/4"

75
29 1/2"

80
31 1/2"

		cat. A	cat. B	cat. C	cat. D	cat. E	cat. E1	cat. G	cat. G2	fabric lmt	leather sqmt
GM_2	Armchair	3.150	3.255	3.355	3.745	3.965	4.755	4.520	4.725	4,62	8,8

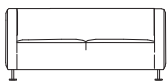
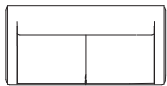

42
16 1/2"
73
28 3/4"

160
63"

80
31 1/2"

		cat. A	cat. B	cat. C	cat. D	cat. E	cat. E1	cat. G	cat. G2	fabric lmt	leather sqmt
GM_8	two-seater sofa	4.475	4.675	4.995	5.160	5.970	7.240	7.140	7.580	6,6	14,3

Code description

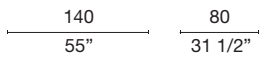
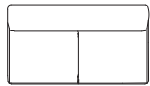

		cat. A	cat. B	cat. C	cat. D	cat. E	cat. E1	cat. G	cat. G2	fabric lmt	leather sqmt
GM_4	two-seater element	3.780	3.950	4.185	4.210	4.870	5.685	5.930	6.270	4,4	11

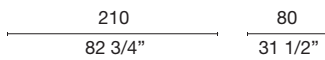
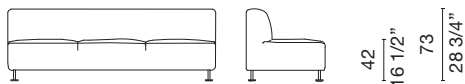

		cat. A	cat. B	cat. C	cat. D	cat. E	cat. E1	cat. G	cat. G2	fabric lmt	leather sqmt
GM_5	three-seater element	4.660	4.885	5.185	5.335	6.200	7.450	7.325	7.730	6,6	14,3

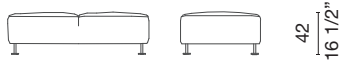

		cat. A	cat. B	cat. C	cat. D	cat. E	cat. E1	cat. G	cat. G2	fabric lmt	leather sqmt
GM_9	two-seater pouf	2.675	2.800	2.975	3.060	3.555	4.285	4.275	4.540	3,85	8,8

Small armchair with a very elegant and timeless design. The structure is made of massive ash wood, while the seat and the backrest are internally upholstered in leather.



Structure

solid ash wood

Structure finish

- 113 bleached ash
- 116 oak-stained ash
- 112 black-stained ash

Seat and backrest

ash veneered beech plywood, internally covered with saddle leather

Cover

fixed in saddle leather in the colours:

- CP4 Avorio Opaco
- CP1 Naturale
- CP5 Talpa
- CP3 Marrone Opaco
- CP2 Nero

Feet

grey felt

Notes

Note 1

Perimetral stitching tone on tone

Note 2

Black painted edge for saddle leather:

- CP3 Marrone Opaco
- CP2 Nero

Tone on tone edge for saddle leather:

- CP4 Avorio Opaco
- CP1 Naturale
- CP5 Talpa

Note 3

Cappellini logo milled under the seat

	A	A ₀		B	B ₀		C		D		E	E ₁	G	G ₂	V																			
Phil	Trame	Vancouver	Sorrento	Sorrento rigato	Ecopelle	Trentino Stretto	Vancouver	Ambro	Bielastico Color	Bielastico Optical	Brecon	Corda	Madrid	Oceanic	Vancouver	Baltimore Plus Eco	Hallingdal 2	Panno	Steelcut Trio	Delft Velvet	Dunmore Plaid	Hardwick Plaid	Hero 2	Ivyside Herringbone	Market Street Plaid	Verommet	Zero	Chandigar	Pelle	Pelle Extra	Spotted leather	Artemidor	Pucci Cotton / Velvet	Hide

Code description

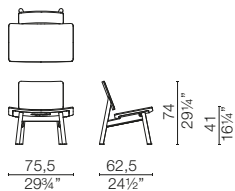

Code	description	Price	leather sqmt
HR_1	Armchair	1.900	1

Series of modular seating elements with feet made of solid ash wood and fixed upholstery in a selection of fabrics and leathers from the collection. Possibility of covering the seat and the backrest with different colours of the same fabric.



Structure

Birch plywood and metal fixing plates for backrests and armrests

Padding

shaped polyurethane foam and fibre

Feet

solid ash

Feet Finish

- 113 bleached ash
- 116 oak-stained ash
- 112 black-stained ash

Cover

- fixed in one colour fabric
- fixed in different colours of the same fabric (drawing needed)
- fixed in leather

Notes

Note 1

In case of modular compositions, the elements are joined together by means of metal hooks (HOB1), to be added when ordering

Note 2

Free combinations of fabrics are not possible

A		A _o		B		B _o		C				D			E					E _i	G	G _s	V																																														
●	Phill	●	Trame	●	Vancouver	●	Sorrento	●	Sorrento rigato	●	Ecopelle	●	Trentino Stretto	●	Vancouver	●	Ambro	●	Bielastico Color	●	Bielastico Optical	●	Brescon	●	Corda	●	Madrid	●	Oceanic	●	Vancouver	●	Baltimore Plus Eco	●	Hallingdal 2	●	Panno	●	Steelcut Trio	●	Delft Velvet	●	Dunmore Plaid	●	Hardwick Plaid	●	Hero 2	●	Ivyside Herringbone	●	Marker Street Plaid	●	Veronnet	●	Zero	●	Chandigar	●	Pelle	●	Pelle Extra	●	Spotted leather	●	Artemidor	●	Pucci Cotton / Velvet	●	Hide

Code description

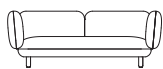
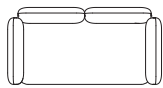

190 74 3/4" 85 33 1/2" 73 28 3/4" 42 16 1/2"

		cat. A	cat. B	cat. C	cat. D	cat. E	cat. E1	cat. G	cat. G2	fabric lmt	leather sqmt
HOB40	two-seater sofa	8.350	8.490	8.670	9.220	9.710	11.520	11.260	12.320	7,8	14

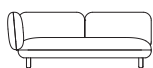

175 69" 85 33 1/2" 73 28 3/4" 42 16 1/2"

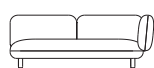
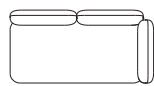

175 69" 85 33 1/2" 73 28 3/4" 42 16 1/2"

		cat. A	cat. B	cat. C	cat. D	cat. E	cat. E1	cat. G	cat. G2	fabric lmt	leather sqmt
HOB41	two-seater left end element	7.305	7.460	7.640	8.120	8.570	10.195	9.965	10.860	7,1	12
HOB42	two-seater right end element	7.305	7.460	7.640	8.120	8.570	10.195	9.965	10.860	7,1	12

Code description

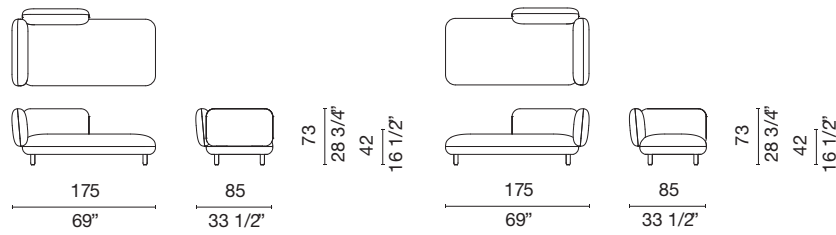

		cat. A	cat. B	cat. C	cat. D	cat. E	cat. E1	cat. G	cat. G2	fabric lmt	leather sqmt
HOB43	Chaise longue - left	6.770	6.875	7.005	7.450	7.805	9.165	8.540	9.295	5,9	10
HOB44	Chaise longue - right	6.770	6.875	7.005	7.450	7.805	9.165	8.540	9.295	5,9	10

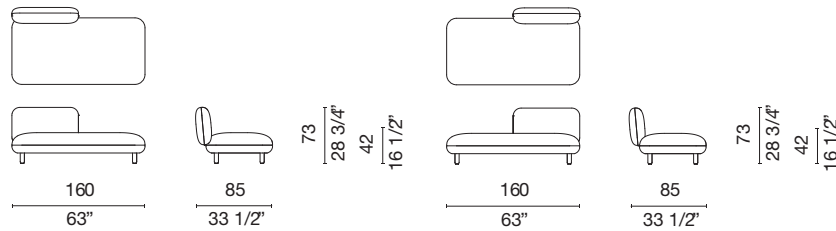

		cat. A	cat. B	cat. C	cat. D	cat. E	cat. E1	cat. G	cat. G2	fabric lmt	leather sqmt
HOB45	two-seater left bench	5.025	5.110	5.225	5.575	5.880	6.980	7.245	7.845	4,8	8
HOB46	two-seater right bench	5.025	5.110	5.225	5.575	5.880	6.980	7.245	7.845	4,8	8

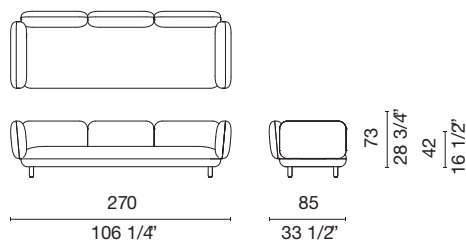

		cat. A	cat. B	cat. C	cat. D	cat. E	cat. E1	cat. G	cat. G2	fabric lmt	leather sqmt
HOB50	three-seater sofa	10.235	10.455	10.735	11.495	12.180	14.720	13.940	15.295	11	18,25

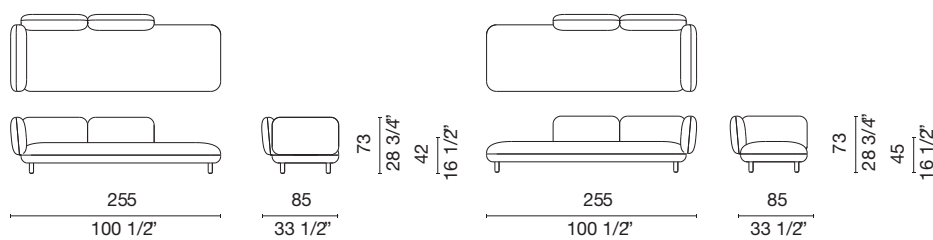

		cat. A	cat. B	cat. C	cat. D	cat. E	cat. E1	cat. G	cat. G2	fabric lmt	leather sqmt
HOB51	three-seater left end element	8.040	8.230	8.410	9.055	9.610	11.630	10.905	11.945	8,8	14,25
HOB52	three-seater right end element	8.040	8.230	8.410	9.055	9.610	11.630	10.905	11.945	8,8	14,25

Hobo Contract

design: Tina Bunyaprasit & Werner Aisslinger 2017

Code description

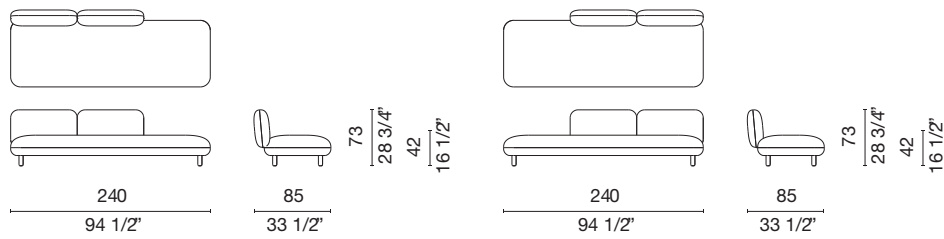

		cat. A	cat. B	cat. C	cat. D	cat. E	cat. E1	cat. G	cat. G2	fabric lmt	leather sqmt
HOB53	three-seater left bench	7.115	7.255	7.450	8.000	8.480	10.235	9.610	10.520	7,7	12,25
HOB54	three-seater right bench	7.115	7.255	7.450	8.000	8.480	10.235	9.610	10.520	7,7	12,25

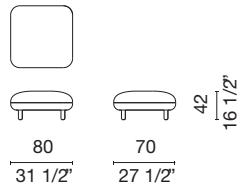

		cat. A	cat. B	cat. C	cat. D	cat. E	cat. E1	cat. G	cat. G2	fabric lmt	leather sqmt
HOBP3	Pouf	2.975	3.015	3.040	3.105	3.165	3.415	3.665	3.820	1,1	2

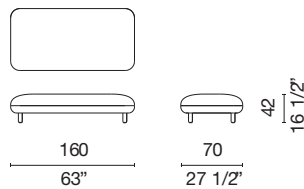

		cat. A	cat. B	cat. C	cat. D	cat. E	cat. E1	cat. G	cat. G2	fabric lmt	leather sqmt
HOBP4	Pouf	3.820	3.900	3.990	4.245	4.470	5.320	5.060	5.500	3,7	6

											Price
HOB1	kit two metal hooks										140

Sofa and bench with metal base and structure made of polish lacquered fiberglass in a selection of colours.



Structure

fiberglass and metal frame

Finish

polish varnished
 802 orange
 803 red
 805 blue
 806 white
 807 black

Base

AISI 304 stainless steel

Base finish

435 satined stainless steel

Feet

black felt pads

Code	description
------	-------------

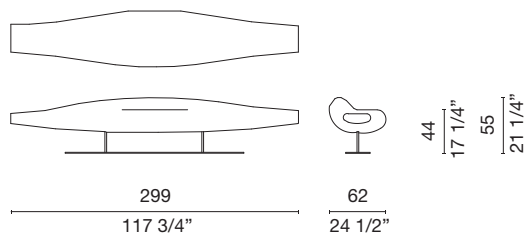

	Price
IO_15 Fiberglass sofa	9.030

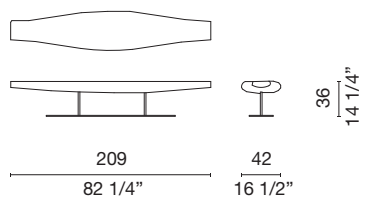

	Price
IO_25 Fiberglass bench	6.005

Knotted Chair



design: Marcel Wanders (Droog Design) 1996

Small armchair with structure in "knotted" rope made of carbon fiber covered with a layer of aramide fiber. Epoxy resin finish to stiffen the structure.

Structure

inner carbon rope
cover in aramide fibre
epoxy resin finish to stiffen the structure



Code	description	Price
		
		
$\frac{53}{21''}$	$\frac{64}{25 \frac{1}{4}''}$	
	$\frac{31}{12 \frac{1}{2}''}$	
	$\frac{69}{27 \frac{1}{4}''}$	
KC_1	Small armchair	4.225

Collection of free-standing and modular seating elements characterised by curved shapes, with removable cover in fabric and fixed cover in leather.



Structure

wood fibre conglomerate panels and pine plywood

Seat padding

multi-density polyurethane foam, memory-foam and polyester fiber

Backrest padding

multi-density polyurethane foam and polyester fibre

Cover

removable in fabric and leather
upon request, the upholstery for each item can be ordered separately

Feet

black plastic with felt pads for seating elements
black plastic, adjustable, for armrests and backrests

Cushions

recommended to complete the compositions, made of polyester fiber and feather

Notes

Note 1

The stitching colour is always in tone on tone thread for both fabrics and leathers

Note 2

Combination of different colours of the same fabric is not available

Note 3

The seats can feature single or double stitched seam according to the selected element and upholstery

Note 4

Given the asymmetric shape of the seating elements, the dimensions of the compositions do not correspond to the sum of the dimensions of the single elements





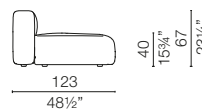
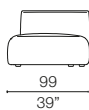
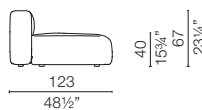
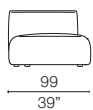













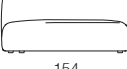

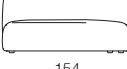
Phill	Trame	Vancouver	Sorrento	Sorrento rigato	Ecopelle	Trentino Stretto	Vancouver	Ambro	Bleilastico Color	Bleilastico Optical	Brecon	Conda	Madrid	Oceanic	Vancouver	Baltimore Plus Eco	Hallingdal 2	Panno	Steelcut Trio	Deift Velvet	Dunmore Plaid	Hardwick Plaid	Hero 2	Ivyside Herringbone	Market Street Plaid	Veronnet	Zero	Chandigar	Pelle	Pelle Extra	Spotted leather	Artemidor	Pucci Cotton / Velvet	Hide	
•	•	•				•	•				•	•	•	•	•		•	•	•								•		•	•	•	•			

Code description

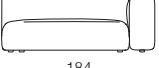

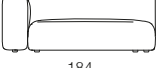
		cat. A	cat. B	cat. C	cat. D	cat. E	cat. G	cat. G2	Artemidor	fabric lmt	leather sqmt
LT_1	Asymmetric left seat without armrest	2.745	2.880	3.065	3.425	3.715	4.075	4.420	5.575	4	7,2
LT_5	Asymmetric right seat without armrest	2.745	2.880	3.065	3.425	3.715	4.075	4.420	5.575	4	7,2

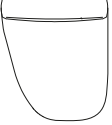
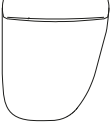
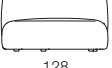
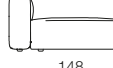
Code description

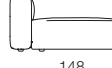
											
		$\frac{40}{15\%}$	$\frac{67}{23\frac{1}{4}\%}$			$\frac{40}{15\%}$	$\frac{67}{23\frac{1}{4}\%}$	129	123	50 $\frac{1}{4}$ "	48 $\frac{1}{2}$ "
LT_1B	Asymmetric seat with left armrest	cat. A	cat. B	cat. C	cat. D	cat. E	cat. G	cat. G2	Artemidor	fabric lmt	leather sqmt
		3.500	3.665	3.895	4.330	4.675	5.280	5.725	6.915	4,8	9,5
LT_5B	Asymmetric seat with right armrest	3.500	3.665	3.895	4.330	4.675	5.280	5.725	6.915	4,8	9,5
											
		$\frac{40}{15\%}$	$\frac{67}{23\frac{1}{4}\%}$			$\frac{40}{15\%}$	$\frac{67}{23\frac{1}{4}\%}$	154	106	60 $\frac{1}{2}$ "	41 $\frac{1}{4}$ "
LT_2	Asymmetric right seat without armrest	cat. A	cat. B	cat. C	cat. D	cat. E	cat. G	cat. G2	Artemidor	fabric lmt	leather sqmt
		3.360	3.535	3.775	4.265	4.650	5.015	5.455	7.120	5,4	9,2
LT_6	Asymmetric left seat without armrest	3.360	3.535	3.775	4.265	4.650	5.015	5.455	7.120	5,4	9,2
											
		$\frac{40}{15\%}$	$\frac{67}{23\frac{1}{4}\%}$			$\frac{40}{15\%}$	$\frac{67}{23\frac{1}{4}\%}$	184	106	72 $\frac{1}{2}$ "	41 $\frac{1}{4}$ "
LT_2B	Asymmetric seat with right armrest	cat. A	cat. B	cat. C	cat. D	cat. E	cat. G	cat. G2	Artemidor	fabric lmt	leather sqmt
		4.115	4.325	4.610	5.165	5.615	6.225	6.765	8.465	6,2	11,5
LT_6B	Asymmetric seat with left armrest	4.115	4.325	4.610	5.165	5.615	6.225	6.765	8.465	6,2	11,5
											
		$\frac{40}{15\%}$	$\frac{67}{23\frac{1}{4}\%}$			$\frac{40}{15\%}$	$\frac{67}{23\frac{1}{4}\%}$	128	148	50 $\frac{1}{2}$ "	58 $\frac{1}{2}$ "
LT_3	Asymmetric right seat without armrest	cat. A	cat. B	cat. C	cat. D	cat. E	cat. G	cat. G2	Artemidor	fabric lmt	leather sqmt
		3.500	3.690	3.935	4.425	4.810	5.175	5.610	7.340	5,5	9,2
LT_7	Asymmetric left seat without armrest	3.500	3.690	3.935	4.425	4.810	5.175	5.610	7.340	5,5	9,2

Code description

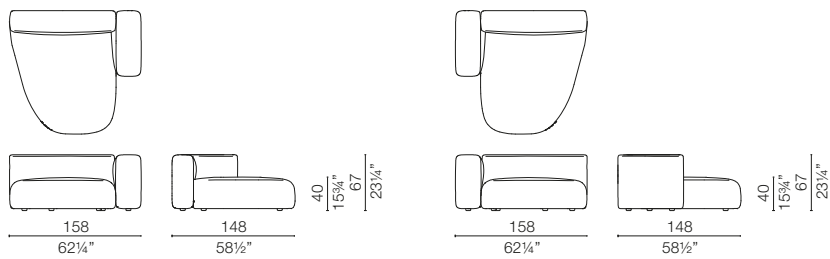

		cat. A	cat. B	cat. C	cat. D	cat. E	cat. G	cat. G2	Artemidor	fabric lmt	leather sqmt
LT_3B	Asymmetric seat with right armrest	4.250	4.470	4.760	5.320	5.785	6.380	6.915	8.690	6,3	11,5
LT_7B	Asymmetric seat with left armrest	4.250	4.470	4.760	5.320	5.785	6.380	6.915	8.690	6,3	11,5

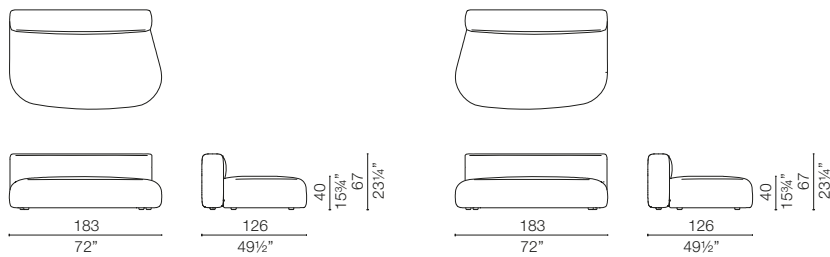

		cat. A	cat. B	cat. C	cat. D	cat. E	cat. G	cat. G2	Artemidor	fabric lmt	leather sqmt
LT_4	Asymmetric left seat without armrest	4.020	4.230	4.500	5.070	5.510	6.060	6.590	8.360	6,2	11,2
LT_8	Asymmetric right seat without armrest	4.020	4.230	4.500	5.070	5.510	6.060	6.590	8.360	6,2	11,2

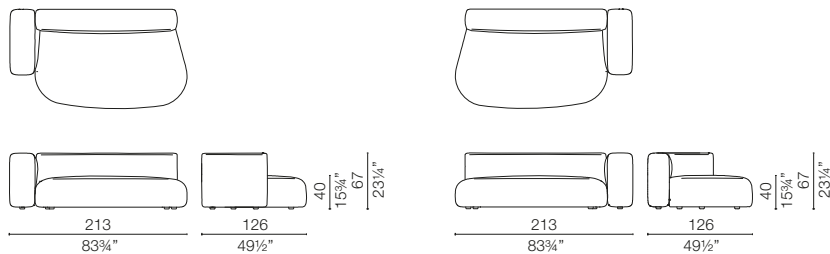

		cat. A	cat. B	cat. C	cat. D	cat. E	cat. G	cat. G2	Artemidor	fabric lmt	leather sqmt
LT_4B	Asymmetric seat with left armrest	4.775	5.010	5.330	5.965	6.470	7.265	7.900	9.720	7	13,5
LT_8B	Asymmetric seat with right armrest	4.775	5.010	5.330	5.965	6.470	7.265	7.900	9.720	7	13,5

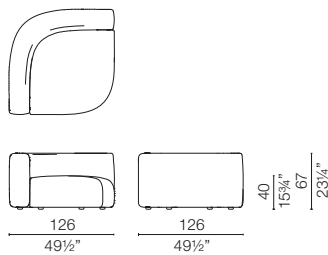

		cat. A	cat. B	cat. C	cat. D	cat. E	cat. G	cat. G2	Artemidor	fabric lmt	leather sqmt
LT_9	Corner seat	3.630	3.800	4.040	4.490	4.860	5.315	5.745	7.185	5	9

Code description

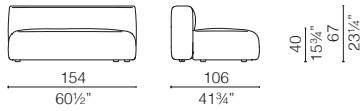

		cat. A	cat. B	cat. C	cat. D	cat. E	cat. G	cat. G2	Artemidor	fabric lmt	leather sqmt
LT_10	Symmetric seat without armrests	3.435	3.620	3.860	4.365	4.765	5.140	5.585	7.325	5,6	9,5

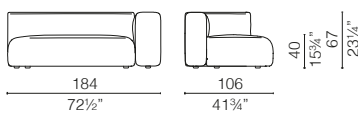
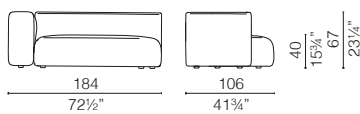
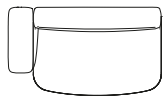

		cat. A	cat. B	cat. C	cat. D	cat. E	cat. G	cat. G2	Artemidor	fabric lmt	leather sqmt
LT_10BL	Symmetric seat with left armrest	4.185	4.405	4.695	5.265	5.725	6.345	6.900	8.675	6,4	11,8
LT_10BR	Symmetric seat with right armrest	4.185	4.405	4.695	5.265	5.725	6.345	6.900	8.675	6,4	11,8

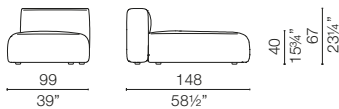
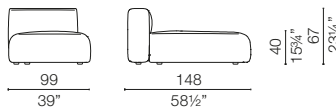

		cat. A	cat. B	cat. C	cat. D	cat. E	cat. G	cat. G2	Artemidor	fabric lmt	leather sqmt
LT_11	Left chaise longue	3.230	3.395	3.630	4.070	4.430	4.695	5.075	6.740	5	8
LT_12	Right chaise longue	3.230	3.395	3.630	4.070	4.430	4.695	5.075	6.740	5	8

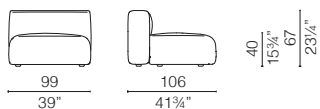

		cat. A	cat. B	cat. C	cat. D	cat. E	cat. G	cat. G2	Artemidor	fabric lmt	leather sqmt
LT_13	Symmetric seat without armrests	2.915	3.055	3.245	3.620	3.905	4.275	4.615	5.765	4	7,2

Code description

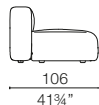
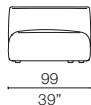

40
15 3/4
67
23 1/4

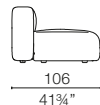
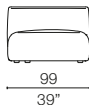

40
15 3/4
67
23 1/4

		cat. A	cat. B	cat. C	cat. D	cat. E	cat. G	cat. G2	Artemidor	fabric lmt	leather sqmt
LT_14	Asymmetric left seat without armrest	2.850	2.990	3.175	3.530	3.820	4.175	4.500	5.635	3,9	7
LT_15	Asymmetric right seat without armrest	2.850	2.990	3.175	3.530	3.820	4.175	4.500	5.635	3,9	7



6 I 2 1/4

		cat. A	cat. B	cat. C	cat. D	cat. E	cat. G	cat. G2	Artemidor	fabric lmt	leather sqmt
LT_45	Cushion	205	235	250	295	340	380	405	610	0,7	1



6 I 2 1/4

		cat. A	cat. B	cat. C	cat. D	cat. E	cat. G	cat. G2	Artemidor	fabric lmt	leather sqmt
LT_55	Cushion	245	260	285	345	390	435	475	685	0,8	1,1



6 I 2 1/4



10,5 I 4

		cat. A	cat. B	cat. C	cat. D	cat. E	cat. G	cat. G2	Artemidor	fabric lmt	leather sqmt
LT_70	Cushion with roller	490	515	550	570	620	670	715	1.040	1,9	2,2

High armchair, with or without armrests, with swivelling four-spoke base on feet and fixed cover in fabric or leather.



Armchair structure

beech plywood

Padding

multi-density polyurethane foam polyurethane foam cushions hot-pressed with cover, elastic belts

Base

four spokes, in die-cast aluminium swivelling and tilting

Base and armrest finish

407 chromed

matt varnished
04 black

Feet

white plastic for chromed base

Cover

fixed in fabric and leather

Fireproof test

UK CONTRACT: BS7176

UK DOMESTIC: BS 5852 crib.5

Greenguard

Lotus (Attesa) has been certified with Greenguard Gold

Phill	A	A ₀	B	B ₀	C				D			E					E ₁	G	G ₂	V														
•	Trame	Vancouver	Sorrento	Sorrento rigato	Ecopelle	Trentino Stretto	Vancouver	Ambro	Bielastico Color	Bielastico Optical	Brecon	Corda	Madrid	Oceanic	Vancouver	Baltimore Plus Eco	Hallingdal 2	Panno	Steelcut Trio	Delft Velvet	Dunmore Plaid	Hardwick Plaid	Hero 2	Ivyside Herringbone	Marker Street Plaid	Veronnet	Zero	Chandigar	Pelle	Pelle Extra	Spotted leather	Artemidor	Fucci Cotton / Velvet	Hide

Code description

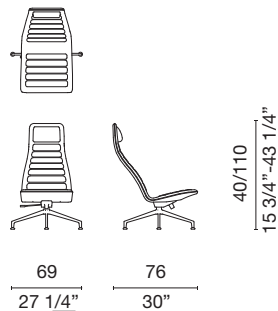

Code	Description	cat. A	cat. B	cat. C	cat. D	cat. E	cat. E1	cat. G	cat. G2	fabric lmt	leather sqmt
LS_1	Armchair	2.735	2.815	2.870	3.010	3.225	3.630	3.355	3.455	2,09	3,52

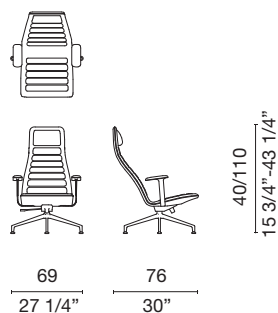

Code	Description	cat. A	cat. B	cat. C	cat. D	cat. E	cat. E1	cat. G	cat. G2	fabric lmt	leather sqmt
LS_1CB	Armchair with armrests	3.150	3.260	3.300	3.430	3.700	4.170	3.805	3.860	2,09	3,52

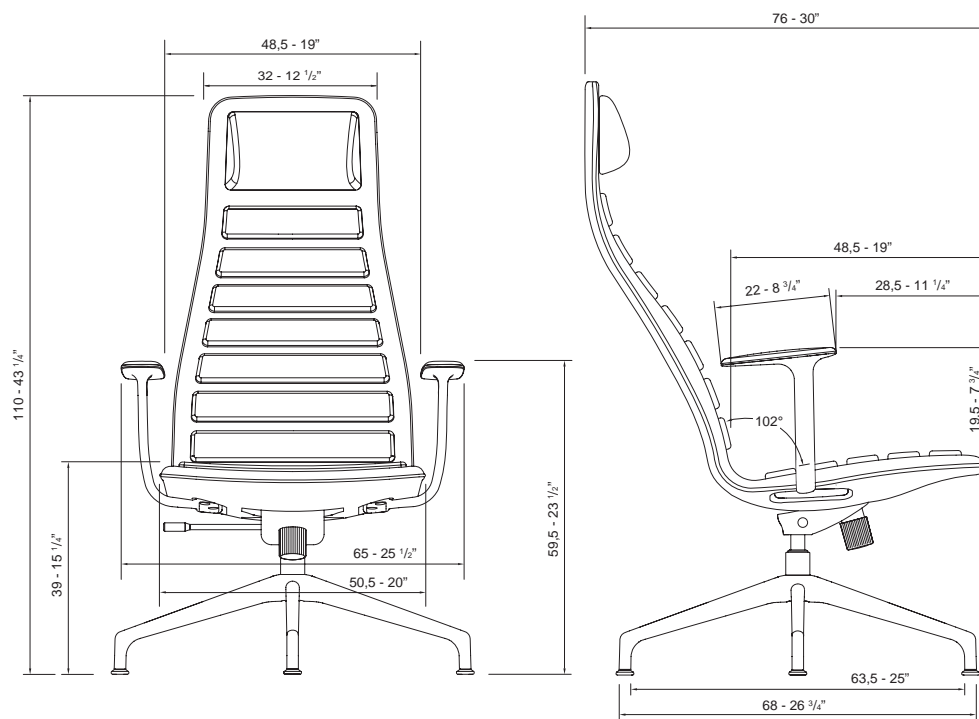

Padded small armchair, available in two heights, with stainless steel legs and fixed cover in fabrics and leathers from the collection.



Structure

beech plywood

Padding

multi-density polyurethane foam

Base finish

435 satined stainless steel

matt varnished

01 white

04 black

71 mud

Cover

fixed in fabric and leather

Feet

grey polyethylene on satin stainless steel and white lacquered base black polyethylene on black and mud lacquered base

Fireproof test

UK CONTRACT: BS7176

UK DOMESTIC: BS 5852 crib.5

Greenguard

Low Pad has been certified with Greenguard Gold

Note

In the fabric version, the profile is closed with a piping in the same material

In the leather version, the profile is varnished with black paint

Phill	A	A ₀	B	B ₀	C	D	E	E ₁	G	G ₂	V
•	Trame		Sorrento rigato		Blelastico Color	Baltimore Plus Eco	ivyside Herringbone		Pelle		Antemidor
•	Vancouver		Ecopelle		Blelastico Optical	Hallingdal 2	Market Street Plaid		Pelle Extra		Pucci Cotton / Velvet
•	Sorrento		Trentino Stretto		Brescon	Panno	Veronnet				Hide
•			Vancouver		Corda	Steelcut Trio	Zero				
•			Ambro		Madrid	Deift Velvet	Chandigar				
•					Oceanic	Dunmore Plaid	Pelle				
•					Vancouver	Hardwick Plaid	Spotted leather				
•					Baltimore Plus Eco	Hero 2	Artemidor				
•					Hallingdal 2	Ivyside Herringbone	Pucci Cotton / Velvet				
•					Panno	Market Street Plaid	Hide				
•					Steelcut Trio	Veronnet					
•					Deift Velvet	Zero					
•					Dunmore Plaid	Chandigar					
•					Hardwick Plaid	Pelle					
•					Hero 2	Spotted leather					
•					Ivyside Herringbone	Artemidor					
•					Market Street Plaid	Pucci Cotton / Velvet					
•					Veronnet	Hide					
•					Zero						
•					Chandigar						
•					Pelle						
•					Spotted leather						
•					Artemidor						
•					Pucci Cotton / Velvet						
•					Hide						

Code description



35,5
14"
74
29 1/4"

58
22 3/4"

72
28 1/4"

		cat. A	cat. B	cat. C	cat. D	cat. E	cat. E1	cat. G	cat. G2	fabric lmt	leather sqmt
LW_1	Small armchair	1.285	1.320	1.350	1.440	1.595	1.780	2.000	2.070	1,3	2,15



40,5
16"
79
31"

58
22 3/4"

72
28 1/4"

		cat. A	cat. B	cat. C	cat. D	cat. E	cat. E1	cat. G	cat. G2	fabric lmt	leather sqmt
LW_3	Small armchair High	1.285	1.320	1.350	1.440	1.595	1.780	2.000	2.070	1,3	2,15

Armchair with structure in recycled and recyclable plastic material, available with different base solutions and removable cover in a selection of fabrics and leathers from the collection.



Structure

shell in recyclable linear polyethylene

Padding

polyurethane foam and polyester fiber

Cover

removable in fabric and leather
upon request, the upholstery for each item can be ordered separately

Stitching

tone on tone

Pouf base

linear polyethylene

Pouf base finish

matt black color with gray felt applied

Conical base

metal sheet, swivelling

Conical base finish

epoxy powder coated, matt black colour

4 spokes base

4 solid ash spokes, with matt black varnished metal structure

4 spokes base finish

116 oak-stained ash
112 black-stained ash

Feet

grey felt for conical base
black plastic for wooden spokes

Note

the coulisse is made of black/white elastic band for all the fabrics and leathers of the collection

A	A ₀	B	B ₀	C	D	E	E ₁	G	G ₂	V
Phill										
Trame										
Vancouver										
Sorrento										
Sorrento rigato										
Ecopelle										
Trentino Stretto										
Vancouver										
Ambro										
Bielastico Color										
Bielastico Optical										
Brescon										
Corda										
Madrid										
Oceanic										
Vancouver										
Baltimore Plus Eco										
Hallingdal 2										
Panno										
Steelcut Trio										
Delft Velvet										
Dunmore Plaid										
Hardwick Plaid										
Hero 2										
Ivyside-Herringbone										
Market Street Plaid										
Veronnet										
Zero										
Chandigar										
Pelle										
Pelle Extra										
Spotted leather										
Artemidor										
Pucci Cotton / Velvet										
Hide										

Code description

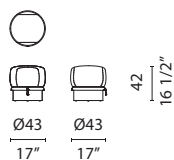

		cat. A	cat. B	cat. C	cat. D	cat. E	cat. E1	cat. G	cat. G2	Artemidor	fabric lmt	leather sqmt
LU_1	Pouf	815	830	880	960	1.005	1.150	1.070	1.125	1.615	1	1,5

Code description



97
38 1/4"
42
16 1/2"

75
29 1/2"

87
34 1/4"

		cat. A	cat. B	cat. C	cat. D	cat. E	cat. E1	cat. G	cat. G2	Artemidor	fabric lmt	leather sqmt
LU_2	Armchair with conical base	3.160	3.250	3.385	3.720	3.960	4.390	4.145	4.375	6.115	4	6



97
38 1/4"
42
16 1/2"

75
29 1/2"

87
34 1/4"

		cat. A	cat. B	cat. C	cat. D	cat. E	cat. E1	cat. G	cat. G2	Artemidor	fabric lmt	leather sqmt
LU_4	Armchair with 4 wooden spokes base	3.525	3.615	3.745	4.060	4.290	4.700	4.470	4.685	6.335	4	6

Small armchair with a very simple and refined design. Structure in massive ash wood and padded seat with fixed upholstery in fabric or leather.



Structure

solid ash

Finish

- 113 bleached ash
- 116 oak-stained ash
- 112 black-stained ash
- 118 blue Shanghai aniline stained ash

Seat

beech plywood ash veneered

Seat padding

multi-density polyurethane foam

Seat cover

fixed in fabric and leather

Feet

black nylon

Notes

Note 1

Seat cushion with border made of the same fabric and leather as the upholstery

Note 2

Seat cushion with upper and lower edge

	A	A ₀		B	B ₀		C		D		E		E ₁	G	G ₂	V	
●	Phill																
●	Trame																
●	Vancouver																
	Sorrento																
	Sorrento rigato																
●	Ecopelle																
●	Trentino Stretto																
●	Vancouver																
	Ambro																
	Bielastico Color																
	Bielastico Optical																
●	Brecon																
●	Corda																
●	Madrid																
●	Oceanic																
●	Vancouver																
	Baltimora Plus Eco																
●	Hallingdal 2																
●	Panno																
	Steelcut Trio																
●	Delft Velvet																
	Dunmore Plaid																
●	Hardwick Plaid																
●	Hero 2																
●	Ivyside Herringbone																
●	Market Street Plaid																
●	Veronnet																
●	Zero																
●	Chandigar																
●	Pelle																
●	Pelle Extra																
	Spotted leather																
●	Artemidor																
	Pucci Cotton / Velvet																
	Hide																

Code description



65,5 25 3/4" 69 27 1/4" 66 26" 40 15 3/4"

	cat. A	cat. B	cat. C	cat. D	cat. E	cat. E1	cat. G	cat. G2	Artemidor	fabric lmt	leather sqmt
NW_3R Small armchair with upholstered seat	2.310	2.355	2.400	2.430	2.480	2.595	2.685	2.895	3.135	0,8	1,2

Small armchair with a very simple and refined design. Structure in massive ash wood and padded seat with fixed upholstery in fabric or leather.



Structure

solid ash

Finish

113 bleached ash
116 oak-stained ash
112 black-stained ash
118 blue Shanghai aniline stained ash

Seat

beech plywood ash veneered

Seat padding

multi-density polyurethane foam

Seat cover

fixed in fabric and leather

Feet

black nylon

Notes

Note 1

Seat cushion with border made of the same fabric and leather as the upholstery

Note 2

Seat cushion with upper and lower edge

	A	A ₀		B	B ₀		C		D		E		E ₁	G	G ₂	V	
●	Phill																
●	Trame																
●	Vancouver																
	Sorrento																
	Sorrento rigato																
●	Ecopelle																
●	Trentino Stretto																
●	Vancouver																
	Ambro																
	Bielastico Color																
	Bielastico Optical																
●	Brecon																
●	Corda																
●	Madrid																
●	Oceanic																
●	Vancouver																
	Baltimora Plus Eco																
●	Hallingdal 2																
●	Panno																
	Steelcut Trio																
●	Delft Velvet																
	Dunmore Plaid																
●	Hardwick Plaid																
●	Hero 2																
●	Ivyside Herringbone																
●	Market Street Plaid																
●	Veronnet																
●	Zero																
●	Chandigar																
●	Pelle																
●	Pelle Extra																
	Spotted leather																
●	Artemidor																
	Pucci Cotton / Velvet																
	Hide																

Code description



65,5
25 3/4"

69
27 1/4"

66
26"

40
15 3/4"

		cat. A	cat. B	cat. C	cat. D	cat. E	cat. E1	cat. G	cat. G2	Artemidor	fabric lmt	leather sqmt
NWX3R	Small armchair with upholstered seat	2.150	2.215	2.255	2.295	2.410	2.455	2.545	2.805	3.010	0,8	1,2

Series of freestanding and modular seating elements, suitable for residential spaces, with an extremely comfortable padding. Modules available in different dimensions, with removable cover in a selection of fabrics and leathers of the collection.



Base

steel frame, epoxy powder lacquered in black colour

Structure

steel tube frame, equipped with elastic belts on seat, armrest and backrest

Padding

cold-foamed polyurethane coupled with multi-density polyurethane foam and polyester fibre wadding

Cover

removable in fabric and leather
upon request, the upholstery for each item can be ordered separately

Feet

adjustable in black plastic

Hinges

black plastic and metal

Notes

Note 1

The modules position can be changed by changing or updating the final composition, even adding new modules at a later time

Note 2

Orders without drawing of the required composition are not accepted

Note 3

Stitching thread colour is always beige, both for fabric and leather

Note 4

Different colour matching of the same fabric available

Note 5

Fabric and leather matching available, subject to Cappellini's approval and quotation





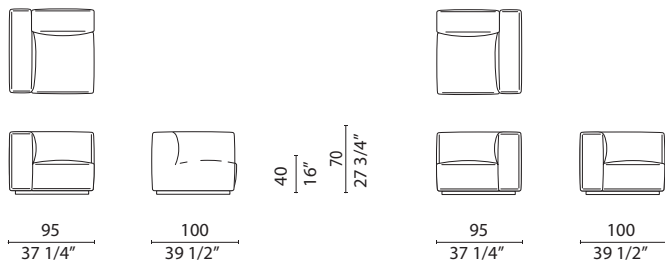







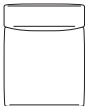

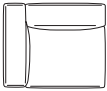
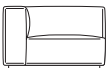
Phil	A	A ₀	B	B ₀	C				D			E				E ₁	G	G ₂	V															
•	Trame	Vancouver	Sorrento	Sorrento rigato	Ecopelle	Trentino Stretto	Vancouver	Ambro	Bielastico Color	Bielastico Optical	Brecon	Corda	Madrid	Oceanic	Vancouver	Baltimora Plus Eco	Hallingdal 2	Panno	Steelcut Trio	Delft Velvet	Dunmore Plaid	Hardwick Plaid	Hero 2	Ivyside Herringbone	Marker Street Plaid	Veronnet	Zero	Chandigar	Pelle	Pelle Extra	Spotted leather	Artemidor	Pucci Cotton / Velvet	Hide

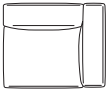
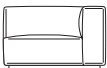
Code description



		cat. A	cat. B	cat. C	cat. D	cat. E	cat. E ₁	cat. G	cat. G ₂
OSX38	Short left corner/end element	2.785	2.990	3.120	3.395	3.635	4.870	3.950	4.175
OSX37	Short right corner/end element	2.785	2.990	3.120	3.395	3.635	4.870	3.950	4.175

Code description

																			
$\frac{95}{37\ 1/4''}$	$\frac{100}{39\ 1/2''}$																		
OSX61	Central element/open end element		cat. A	cat. B	cat. C	cat. D	cat. E	cat. E1	cat. G	cat. G2									
			2.225	2.440	2.530	2.720	2.895	3.770	3.140	3.300									
																			
$\frac{95}{37\ 1/4''}$	$\frac{115}{45\ 1/4''}$																		
OSX34	Dormeuse		cat. A	cat. B	cat. C	cat. D	cat. E	cat. E1	cat. G	cat. G2									
			2.560	2.690	2.795	2.995	3.180	4.095	3.430	3.605									
																			
$\frac{125}{49\ 1/4''}$	$\frac{100}{39\ 1/2''}$																		
																			
$\frac{125}{49\ 1/4''}$	$\frac{100}{39\ 1/2''}$																		
OSX32	Large left end element		cat. A	cat. B	cat. C	cat. D	cat. E	cat. E1	cat. G	cat. G2									
OSX31	Large right end element		3.065	3.285	3.455	3.895	4.155	5.430	4.530	4.760									
			3.065	3.285	3.455	3.895	4.155	5.430	4.530	4.760									
																			
$\frac{75}{29\ 1/2''}$	$\frac{95}{37\ 1/4''}$																		
OSX92	Open element/ottoman		cat. A	cat. B	cat. C	cat. D	cat. E	cat. E1	cat. G	cat. G2									
			1.340	1.510	1.560	1.665	1.765	2.260	1.890	1.980									
																			
$\frac{95}{37\ 1/4''}$	$\frac{95}{37\ 1/4''}$																		
OSX93	Big open element/big ottoman		cat. A	cat. B	cat. C	cat. D	cat. E	cat. E1	cat. G	cat. G2									
			1.565	1.715	1.770	1.890	1.995	2.530	2.135	2.240									

Chaise longue manufactured in fiberglass polish lacquered in a selection of colours.



Structure

fiberglass

Finish

polish varnished
 802 orange
 803 red
 805 blue
 806 white
 807 black

Feet

black plastic

Note

Suitable for outdoor

Code description



32
12 1/2"
50
19 3/4"

38
15"
74
29 1/4"

181
71 1/4"

		Price
MN_4	Chaise longue	5.705

Series of seating elements with soft and embracing lines, characterised by a thin shell containing wide and comfortable cushions with upholstery in fabrics and leathers of the collection.



Sofas and pouf structure

composite rigid polyurethane with elements in poplar plywood and elastic belts

Armchair and small armchair structure

foam with metal frame and elastic belts

Padding

multi-density polyurethane foam and fibre

Base

medium-density wooden conglomerate panel

Base finish

matt lacquer
04 black

Feet

grey felt pads

Castors

only on small armchair without swivelling mechanism, self-blocking round casters, white colour

Swivelling base on armchair (ORL1G)

the standard swivelling base is not equipped with spring return mechanism

a spring return mechanism can be added upon request, with an extra charge of € 150,00

Swivelling base on small armchair

steel swivelling base with spring return mechanism, painted natural aluminium RAL 9006

Structure cover

fixed in fabric and leather

Cushions cover

removable in fabric and leather

Cushion cover for small armchair and small sofa

fixed in fabric and leather

Notes

Note 1

Stitch thread in the same fabric and leather colour

Note 2

Free fabric matching between armchair and seat cushion not available

Note 3

Loose seat cushions for sofas (not small sofa), armchair and pouf

	A	A ₀	B	B ₀	C	D	E	E ₁	G	G ₂	V
●	Phill										
●	Trame										
●	Vancouver										
	Sorrento										
	Sorrento rigato										
●	Ecopelle										
	Trentino Stretto										
	Vancouver										
	Ambro										
	Bielastico Color										
	Bielastico Optical										
●	Brecon										
	Corda										
●	Madrid										
●	Oceanic										
●	Vancouver										
	Baltimore Plus Eco										
●	Hallingdal 2										
●	Panno										
●	Steelcut Trio										
●	Delft Velvet										
●	Dunmore Plaid										
●	Hardwick Plaid										
●	Hero 2										
●	Ivyside Herringbone										
●	Market Street Plaid										
●	Veronnet										
●	Zero										
●	Chandigar										
●	Pelle										
●	Pelle Extra										
	Spotted leather										
	Artemidor										
	Pucci Cotton / Velvet										
	Hide										

Code description



43
17" 70
27 2/4"

66,5
26 1/4"

68
26 3/4"

		cat. A	cat. B	cat. C	cat. D	cat. E	cat. E1	cat. G	cat. G2	fabric lmt	leather sqmt
ORL4	Fixed small armchair	3.270	3.310	3.395	3.605	4.050	4.350	4.185	4.860	3	6



43
17" 70
27 2/4"

66,5
26 1/4"

68
26 3/4"

		cat. A	cat. B	cat. C	cat. D	cat. E	cat. E1	cat. G	cat. G2	fabric lmt	leather sqmt
ORL4G	Swivel small armchair with return mechanism	3.735	3.815	3.860	4.100	4.570	4.885	4.655	5.120	3	6

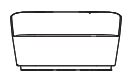

70
27 1/2"

133
52 1/4"

68,5
27"

		cat. A	cat. B	cat. C	cat. D	cat. E	cat. E1	cat. G	cat. G2	fabric lmt	leather sqmt
ORL2S	Small sofa	5.715	5.875	6.035	6.340	6.980	7.455	7.135	7.925	4,4	7,3



42/59
16 1/2"-23 1/4"

86
33 3/4"

83
32 3/4"

		cat. A	cat. B	cat. C	cat. D	cat. E	cat. E1	cat. G	cat. G2	fabric lmt	leather sqmt
ORL1	Armchair	3.875	4.005	4.100	4.435	4.930	5.280	5.040	5.710	4,3	7,3



42/59
16 1/2"-23 1/4"

86
33 3/4"

83
32 3/4"

		cat. A	cat. B	cat. C	cat. D	cat. E	cat. E1	cat. G	cat. G2	fabric lmt	leather sqmt
ORL1G	Swivel armchair	4.785	4.905	5.015	5.350	5.815	6.120	5.935	6.550	4,3	7,3

Code description

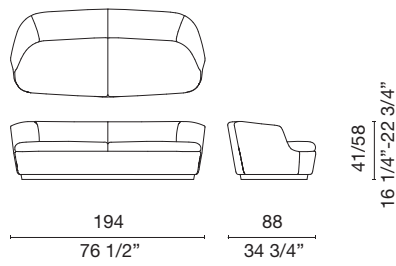

		cat. A	cat. B	cat. C	cat. D	cat. E	cat. E1	cat. G	cat. G2	fabric lmt	leather sqmt
ORL2	Two-seater sofa	6.250	6.565	6.745	7.465	8.490	9.105	8.610	9.950	7,5	13

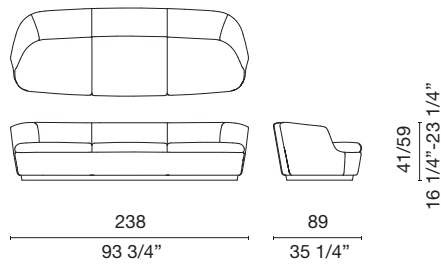

		cat. A	cat. B	cat. C	cat. D	cat. E	cat. E1	cat. G	cat. G2	fabric lmt	leather sqmt
ORL3	Three-seater sofa	7.265	7.620	7.865	8.770	9.990	10.750	10.135	11.765	9,5	16

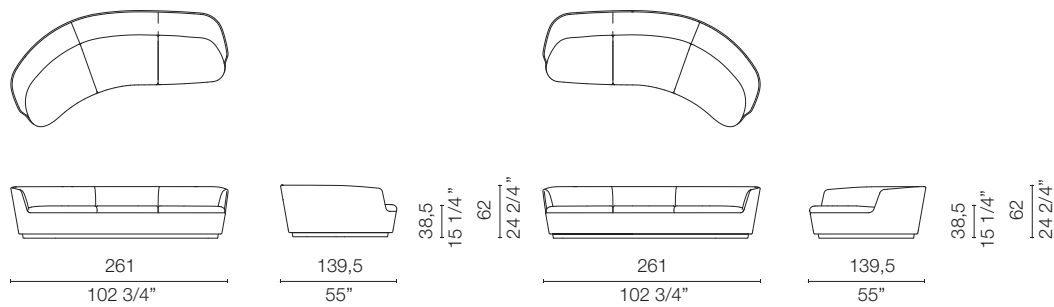

		cat. A	cat. B	cat. C	cat. D	cat. E	cat. E1	cat. G	cat. G2	fabric lmt	leather sqmt
ORL6	Curved sofa - left-hand	9.290	9.635	9.995	11.025	11.925	15.295	12.105	13.530	13,5	20,5
ORL5	Curved sofa - right-hand	9.290	9.635	9.995	11.025	11.925	15.295	12.105	13.530	13,5	20,5

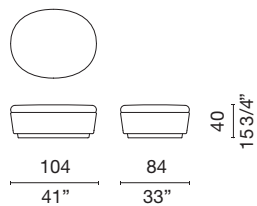

		cat. A	cat. B	cat. C	cat. D	cat. E	cat. E1	cat. G	cat. G2	fabric lmt	leather sqmt
ORL7	Pouf	3.905	3.995	4.065	4.340	4.560	5.405	5.165	5.610	4,2	6,5

Small armchair made of crumpled sheets of felt on metal base.



Structure

wool and rayon felt

Structure finish

1710 green felt
1713 blue felt

Base

metal

Base finish

powder painted, anthracite colour

Feet

black plastic

Code description

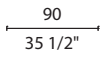
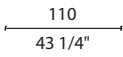
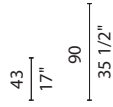
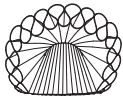

		Price
PCK1	Armchair	12.670

Low and curved small armchair, with legs made of massive ash wood and fixed upholstery in a selection of fabrics and leathers from the collection.



Structure

seat in co-injection of stiff polyurethan and soft foam

Seat

foam with elements in beech plywood and poplar

Seat cover

fixed in fabric and leather

Base

solid ash with self-blocking sphere casters

Base finish

113 bleached ash
116 oak-stained ash
112 black-stained ash

Notes

Note 1

Seat and backrest free matching with selected fabrics and leathers:

for backrest and seat in different fabrics = highest category price to be calculated

for backrest in leather and seat in fabric or viceversa = highest category price to be calculated

Note 2

Thread in the same fabric or leather colour

	A	A ₀		B	B ₀		C			D			E			E ₁	G	G ₂	V	
●	Phill																			
●	Trame																			
	Vancouver																			
	Sorrento																			
	Sorrento rigato																			
	Ecopelle																			
	Trentino Stretto																			
●	Vancouver																			
	Ambro																			
	Bielastico Color																			
	Bielastico Optical																			
	Brecon																			
	Cordia																			
●	Madrid																			
●	Oceanic																			
●	Vancouver																			
	Baltimore Plus Eco																			
●	Hallingdal 2																			
●	Panno																			
	Steelcut Trio																			
	Delft Velvet																			
●	Dummore Plaid																			
●	Hardwick Plaid																			
●	Hero 2																			
●	Ivyside Herringbone																			
●	Market Street Plaid																			
	Veronnet																			
●	Zero																			
	Chandigar																			
●	Pelle																			
●	Pelle Extra																			
	Spotted leather																			
	Atramiador																			
	Pucci Cotton / Velvet																			
	Hide																			

Code description



66,5
26 1/4"

59
23 1/4"

59,5
23 1/2"

		cat. A	cat. B	cat. C	cat. D	cat. E	cat. G	cat. G ₂	fabric lmt	leather sqmt
PEG2R	Small armchair	2.170	2.250	2.295	2.440	2.615	2.675	2.645	2,2	2,37

Armchair with hand-carved and handpainted massive beech frame, upholstered with fixed multicolour dotted fabric matching the pattern of the structure.



Structure

hand-carved and hand-painted solid beech

Padding

multi-density polyurethane foam

Cover

multicolour fabric matching the colours of the structure
 light blue/grey/yellow multicolour fabric (PR_1)
 black/green/red multicolour fabric (PR_2)

Feet

transparent plastic

Code	description
------	-------------

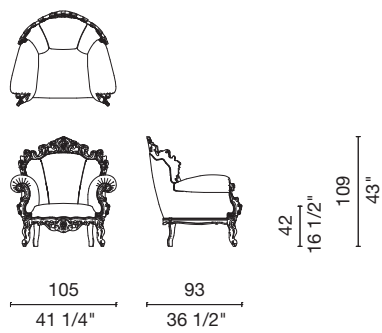

PR_1	Armchair	Price
		12.130

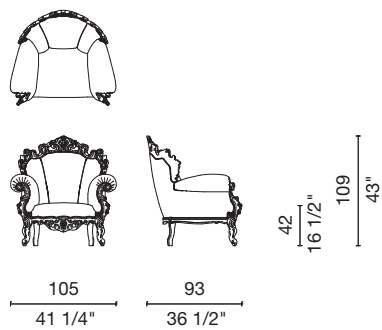

PR_2	Armchair	Price
		12.130

Armchair with hand-carved and handpainted massive beech frame, upholstered with fixed multicolour geometric fabric matching the pattern of the structure.



Structure

hand-carved and hand-painted solid beech

Padding

multi-density polyurethane foam

Cover

fixed in cotton fabric

Feet

transparent plastic

Code description

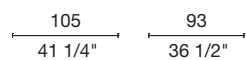
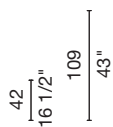

PR_3 Armchair

Price

12.130

Swivel armchair with stainless steel base and fixed upholstery in fabrics and leathers from the collection and in a selection of cotton and velvet fabrics designed by Emilio Pucci.



Structure

polyurethane foam with metal frame

Seat

poplar plywood frame and multi-density polyurethane foam

Base

swivel, in satined stainless steel

Cover

fixed in fabric and leather

fixed in Pucci cotton and velvet

Feet

black felt pads

	A	A _o		B	B _o	C				D			E				E ₁	G	G ₂	V			
●	Phill																						
●	Trame																						
	Vancouver																						
	Sorrento																						
	Sorrento rigato																						
	Ecopelle																						
●	Trentino Stretto																						
●	Vancouver																						
	Ambro																						
	Blelastico Color																						
	Blelastico Optical																						
	Brescon																						
	Conda																						
●	Madrid																						
●	Oceanic																						
●	Vancouver																						
	Baltimore Plus Eco																						
●	Hallingdal 2																						
●	Panno																						
	Steelcut Trio																						
●	Deift Velvet																						
●	Dunmore Plaid																						
●	Hardwick Plaid																						
●	Hero 2																						
●	Ivyside Herringbone																						
●	Market Street Plaid																						
	Veronnet																						
●	Zero																						
●	Chandigar																						
●	Pelle																						
●	Pelle Extra																						
	Spotted leather																						
	Artemidor																						
●	Pucci Cotton / Velvet																						
	Hide																						

Code description



38,5
15 1/4"
71
28"

93,5
36 3/4"

73,5
28 3/4"

Price

RD_3 Armchair Pucci cotton

3.990



38,5
15 1/4"
71
28"

93,5
36 3/4"

73,5
28 3/4"

Price

RD_4 Armchair Pucci velvet

4.300



38,5
15 1/4"
71
28"

93,5
36 3/4"

73,5
28 3/4"

		cat. A	cat. B	cat. C	cat. D	cat. E	cat. G	cat. G ₂	fabric lmt	leather sqmt
RD_5	Armchair	3.495	3.590	3.755	4.260	4.475	4.525	4.560	3,2	5,6

Lounge armchair made of polyurethane foam on metal or wooden feet with removable cover in fabrics and leathers from the collection.



Structure

medium-density conglomerate wooden panels, solid fir, poplar plywood

Padding

multi-density polyurethane foam and feather

Cover

removable in fabric and leather
upon request, the upholstery for each item can be ordered separately

Feet

metal or wood

Feet finish

polish chrome
natural beech
walnut-stained beech
wengé-stained beech

Phil	A	A ₀	B	B ₀	C	D	E	E ₁	G	G ₂	V
•	Trame		Sorrento		Bielastico Color	Baltimore Plus Eco	Hero 2		Pelle		
•	Vancouver		Sorrento figato		Bielastico Optical	Hallingdal 2	Ivyside Herringbone		Pelle Extra		
•	Sorrento		Ecoppelle		Brecon	Panno	Market Street Plaid		Spotted leather		
•			Trentino Stretto		Corda	Steelcut Trio	Vermet		Atemidor		
•			Vancouver		Madrid	Delft Velvet	Zero		Pucci Cotton / Velvet		
•					Oceanic	Dummore Plaid	Chandigar		Hide		
•					Vancouver	Hardwick Plaid	Pelle				
•					Baltimore Plus Eco	Hero 2					
•					Hallingdal 2	Ivyside Herringbone					
•					Panno	Market Street Plaid					
•					Steelcut Trio	Vermet					
•					Delft Velvet	Zero					
•					Dummore Plaid	Chandigar					
•					Hardwick Plaid	Pelle					
•					Hero 2						
•					Ivyside Herringbone						
•					Market Street Plaid						
•					Vermet						
•					Zero						
•					Chandigar						
•					Pelle						
•					Pelle Extra						
•					Spotted leather						
•					Atemidor						
•					Pucci Cotton / Velvet						
•					Hide						

Code description



37
14 1/2"
66
26"

66
26"

81
32"

		cat. A	cat. B	cat. C	cat. D	cat. E	cat. E1	cat. G	cat. G2	fabric lmt	leather sqmt
M3088	Armchair	2.270	2.415	2.545	2.860	3.330	4.005	3.690	3.845	4,4	7,15

Small armchair with tubular metal structure and polyurethane foam padding. Fixed cover in fabrics and leathers from the collection.



Structure

metal tube
with seat in poplar plywood
back: in solid fir-tree and medium density wooden conglomerate parts

Structure finish

407 chromed

matt painted
04 black

Padding

multi-density polyurethane foam

Cover

fixed in fabric and leather

Feet

white plastic

Phil	A	A ₀	B	B ₀	C				D			E				E ₁	G	G ₂	V
•	Trame		Sorrento																
•	Vancouver		Sorrento figato																
•			Ecoppelle																
•			Trentino Stretto																
•			Vancouver																
•			Ambro																
•			Bielastico Color																
•			Bielastico Optical																
•			Brecon																
•			Corda																
•			Madrid																
•			Oceanic																
•			Vancouver																
•			Baltimora Plus Eco																
•			Hallingdal 2																
•			Panno																
•			Steelcut Trio																
•			Delft Velvet																
•			Dummore Plaid																
•			Hardwick Plaid																
•			Hero 2																
•			Ivyside Herringbone																
•			Market Street Plaid																
•			Veronnet																
•			Zero																
•			Chandigar																
•			Pelle																
•			Pelle Extra																
•			Spotted leather																
•			Atemidor																
•			Pucci Cotton / Velvet																
•			Hide																

Code description



38
15
65,5
25 3/4

62
24 1/2"

92
35 1/2"

		cat. A	cat. B	cat. C	cat. D	cat. E	cat. E1	cat. G	cat. G2	fabric lmt	leather sqmt
PC_17	Armchair with chromed base	3.205	3.315	3.370	3.525	3.770	4.325	3.945	4.075	1,82	2,75
PC_170	Armchair with varnished base	3.205	3.315	3.370	3.525	3.770	4.325	3.945	4.075	1,82	2,75

Armchair with stainless steel base and fixed cover in fabrics and leathers from the collection. Possibility of combining different colours and fabrics for the front and the back.



Structure

rigid moulded polyurethane with metal frame

Base

435 satined stainless steel

Padding

polyurethane foam

Cover

fixed in fabric and leather
for front and back in different fabrics = highest category price to be calculated

Feet

polyethylene anthracite colour

Note

In the fabric version, the profile is closed with a piping in the same material
In the leather version, the profile is varnished with a tone-on-tone paint

	A	A ₀		B	B ₀	C				D			E				E ₁	G	G ₂	V			
•	Phil																						
•	Trame																						
	Vancouver																						
	Sorrento																						
	Sorrento rigato																						
•	Ecopelle																						
•	Trentino Stretto																						
•	Vancouver																						
	Ambro																						
	Bielastico Color																						
	Bielastico Optical																						
	Brecon																						
	Corda																						
•	Madrid																						
•	Oceanic																						
•	Vancouver																						
	Baltimore Plus Eco																						
•	Hallingdal 2																						
•	Panno																						
	Steelcut Trio																						
	Delft Velvet																						
•	Dunmore Plaid																						
•	Hardwick Plaid																						
•	Hero 2																						
•	Ivyside Herringbone																						
•	Market Street Plaid																						
	Veronmet																						
•	Zero																						
	Chandigar																						
•	Pelle																						
•	Pelle Extra																						
	Spotted leather																						
	Artemidor																						
	Pucci Cotton / Velvet																						
	Hide																						

Code description



33
13"
67
26" 1/4"

78
30 3/4"

76
30"

		cat. A	cat. B	cat. C	cat. D	cat. E	cat. E1	cat. G	cat. G2	fabric lmt	leather sqmt
SG_1T	Armchair	2.075	2.110	2.170	2.325	2.560	2.885	2.985	3.060	2,42	3,85

Swivel padded armchair with stainless steel base and structure made of bent birch plywood. Fixed upholstery in fabrics and leathers from the collection.



Structure

bent beech plywood

Padding

multi-density polyurethane foam

Base finish

435 in satined stainless steel

matt varnished

01 white

04 black

71 mud

Cover

fixed in fabric and leather

fixed in white/black spotted leather 851

Fireproof test

UK CONTRACT: BS7176

UK DOMESTIC: BS 5852 crib.5

Greenguard

Sunset has been certified with Greenguard Gold

Phill	A	A ₀	B	B ₀	C				D			E					E ₁	G	G ₂	V														
•	Trame	Vancouver	Sorrento	Sorrento rigato	Ecopelle	Trentino Stretto	Vancouver	Ambro	Bielastico Color	Bielastico Optical	Brecon	Corda	Madrid	Oceanic	Vancouver	Baltimore Plus Eco	Hallingdál 2	Panno	Steelcut Trio	Delft Velvet	Dunmore Plaid	Hardwick Plaid	Hero 2	Ivyside Herringbone	Market Street Plaid	Veronnet	Zero	Chandigar	Pelle	Pelle Extra	Spotted leather	Artemidor	Pucci Cotton / Velvet	Hide

Code description



41
16 1/4"
75
29 1/2"

82
32 1/4"

64
25 1/4"

		cat. A	cat. B	cat. C	cat. D	cat. E	cat. E1	cat. G	cat. G2	Spotted leath V	fabric lmt	leather sqmt
SU_11	Armchair	2.885	2.980	3.025	3.155	3.415	3.695	3.710	3.825	4.750	2,31	4,07

Relax armchair, consisting only of structural metal elements, whose armrests are provided with small cup holder trays.



Structure

metal tube (structure)
flat metal bars (seat and backrest)

Structure finish

embossed powder coating
OC1 pure white - RAL 9010
OC2 violet blue - RAL 5000
OC3 oxide red - RAL 3009

Feet

black plastic

Code description



35
13 3/4"
70
27 1/2"

63,5
25"

96
37 3/4"

TM_1 Armchair

Price

2.460



35
13 3/4"
70
27 1/2"

63,5
25"

96
37 3/4"

TM_2 Red armchair with writings

Price

2.560

Collection of upholstered elements characterised by the peculiar line of the seat, with aluminium feet and fixed cover in fabrics and leathers from the collection.



Structure

poplar plywood and solid fir

Padding

multi-density polyurethane foam

Feet

die-cast polish natural aluminium

Cover

fixed in fabric and leather

	A	A ₀	B	B ₀	C			D			E			E ₁	G	G ₂	V		
●	Phill																		
●	Trame																		
●	Vancouver																		
	Sorrento																		
	Sorrento rigato																		
●	Ecopelle																		
●	Trentino Stretto																		
●	Vancouver																		
	Ambro																		
●	Blelastico Color																		
	Blelastico Optical																		
●	Brecon																		
	Corda																		
●	Madrid																		
●	Oceanic																		
●	Vancouver																		
	Baltimore Plus Eco																		
●	Hallingdai 2																		
●	Panno																		
●	Steelcut Trio																		
●	Deft Velvet																		
●	Dunmore Plaid																		
●	Hardwick Plaid																		
●	Hero 2																		
●	Ivyside Herringbone																		
●	Market Street Plaid																		
●	Veronnet																		
●	Zero																		
●	Chandigar																		
●	Pelle																		
●	Pelle Extra																		
	Spotted leather																		
	Artemidor																		
	Pucci Cotton / Velvet																		
	Hilde																		

Code description



28
11
41
16 1/4
72
28 1/4

135
53 1/4

70
27 1/2

		cat. A	cat. B	cat. C	cat. D	cat. E	cat. E1	cat. G	cat. G2	fabric lmt	leather sqmt
TSA3	Chaise longue	2.980	3.110	3.200	3.430	3.730	4.320	4.415	4.615	3,3	6,05

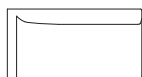

30
11 3/4
47
18 1/2
72
28 1/4

135
53 1/4

70
27 1/2

		cat. A	cat. B	cat. C	cat. D	cat. E	cat. E1	cat. G	cat. G2	fabric lmt	leather sqmt
TSA4	Sofa with left armrest	3.685	3.845	4.000	4.335	4.795	5.665	5.785	6.065	4,95	9,02

Three Sofa de Luxe

design: Jasper Morrison 1992

Code description

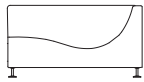
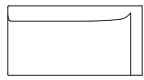

30
11 3/4"
47
18 1/2"
72
28 1/4"

135
53 1/4"

70
27 1/2"

	cat. A	cat. B	cat. C	cat. D	cat. E	cat. E1	cat. G	cat. G2	fabric lmt	leather sqmt
TSA5 Sofa with right armrest	3.685	3.845	4.000	4.335	4.795	5.665	5.785	6.065	4,95	9,02



30
11 3/4"
47
18 1/2"
72
28 1/4"

200
78 3/4"

70
27 1/2"

	cat. A	cat. B	cat. C	cat. D	cat. E	cat. E1	cat. G	cat. G2	fabric lmt	leather sqmt
TSA6 Sofa without backrest	3.780	3.985	4.095	4.405	4.815	5.635	5.725	5.990	4,51	8,25

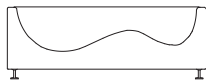

30
11 3/4"
47
18 1/2"
72
28 1/4"

200
78 3/4"

70
27 1/2"

	cat. A	cat. B	cat. C	cat. D	cat. E	cat. E1	cat. G	cat. G2	fabric lmt	leather sqmt
TSA7 Sofa with backrest	4.915	5.175	5.335	5.860	6.470	7.670	7.790	8.175	6,82	12,43

Modular armchair made up of four hollow cylindrical modules in different dimensions, which can be inserted one into the other and freely positioned according to the user's needs.



Structure

polypropylene in four different diameters

Structure finish

white

Padding

polyurethane foam

Cover

fixed in leather

fixed in bielastico color fabric cat. C

Note

Note 1

The tubes are fixed together by metal hooks et gummi spheres in terracotta colour

Note 2

The armchair is equipped with a jute bag with writing

Phill	A	A ₀	B	B ₀	C	D	E	E ₁	G	G ₀	V																								
	Trame	Vancouver	Sorrento	Sorrento rigato	Ecopelle	Trentino Stretto	Vancouver	Ambro	Bielastico Color	Bielastico Optical	Brecon	Corda	Madrid	Oceanic	Vancouver	Baltimore Plus Eco	Hallingdal 2	Panno	Steelcut Trio	Delft Velvet	Dunmore Plaid	Hardwick Plaid	Hero 2	Ilyside Herringbone	Market Street Plaid	Veromet	Zero	Chandigar	Pelle	Pelle Extra	Spotted leather	Artemidor	Pucci Cotton / Velvet	Hide	
									●																										

Code description

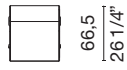

115
45 1/4"

62
24 1/2"

Code	Description	cat. C	cat. G	cat. G2	fabric lmt	leather sqmt
TUC1	Armchair with modular cylinders	3.585	4.170	4.655	2,2	5

Compositions examples

01

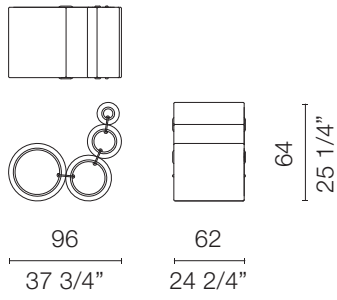

02

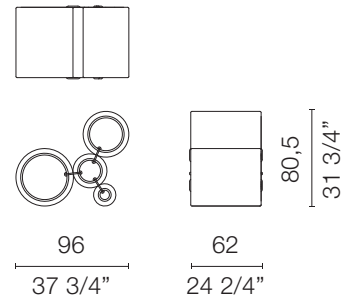

03

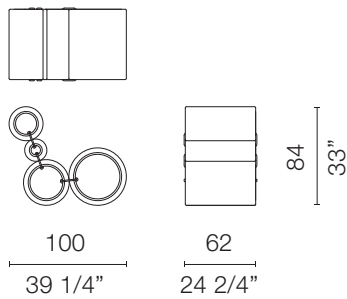

04

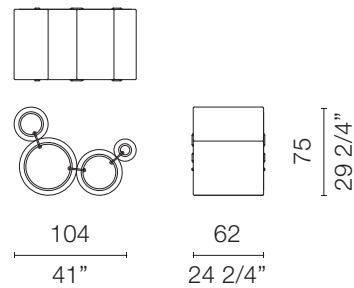

05

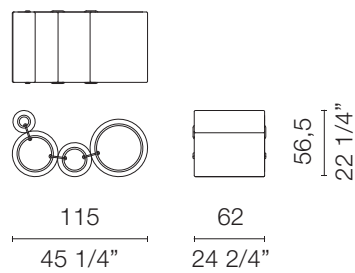

06

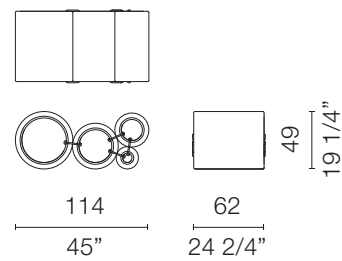

07

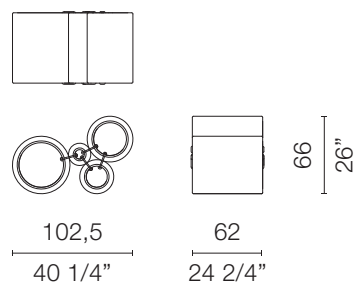

08

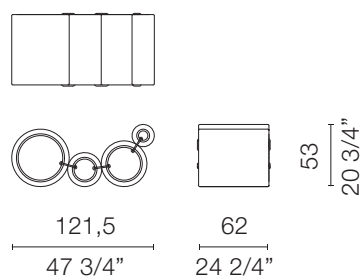

09

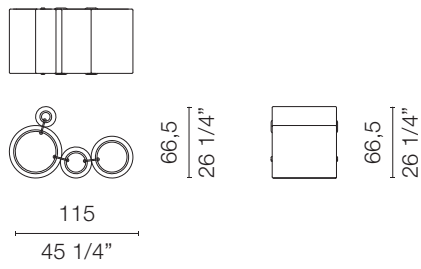

10

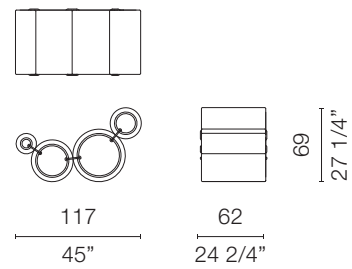

11

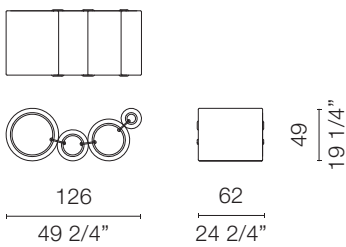

12

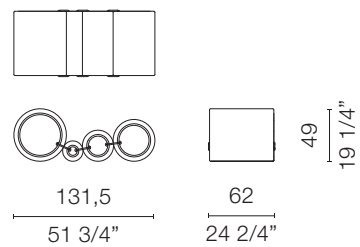

13

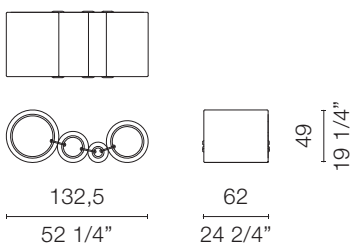

14

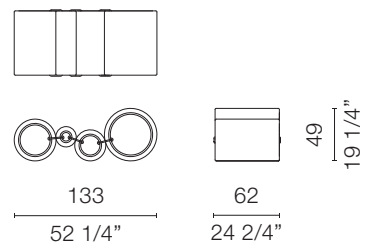

15

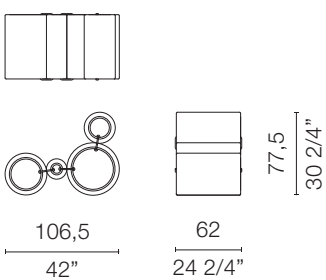

16

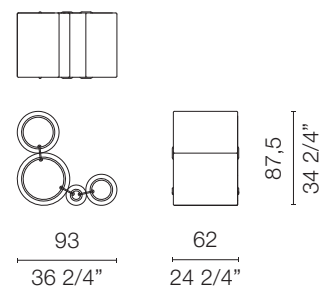

Padded armchair characterised by a very sculptural presence, on swivelling steel base with fiberglass shell evoking the silhouette of a flower.



Structure

fiberglass and resin shell

Padding

moulded and polyurethane foam

Cover

fixed in fabric and leather

Inner seat structure

polyurethane foam with poplar plywood frame and elastic belts

Base

swivel
in steel

Base finish

painted natural aluminium

Feet

black felt pads

Resistance test

The item has been tested following these regulations:

- ANSI BIFMA X5.4-2002
- EN 1728:2000- UNI EN 15373:2007 Level 3
- EN 1335:2000

Test copies available on request.

Fireproof test

UK CONTRACT and UK DOMESTIC: test copy available on request

Greenguard

Wanders' Tulip Armchair has been certified with Greenguard Gold

	A	A ₀		B	B ₀		C				D			E				E ₁	G	G ₂	V						
•	Phil																										
•	Trame																										
	Vancouver																										
	Sorrento																										
	Sorrento figato																										
•	Ecopelle																										
	Trentino Stretto																										
•	Vancouver																										
	Ambro																										
	Bielastico Color																										
	Bielastico Optical																										
•	Brecon																										
	Corda																										
•	Madrid																										
•	Oceanic																										
•	Vancouver																										
	Baltimore Plus Eco																										
•	Hallingdal 2																										
•	Panno																										
	Steelcut Trio																										
•	Delft Velvet																										
•	Dummore Plaid																										
•	Hardwick Plaid																										
•	Hero 2																										
•	Ivyside Herringbone																										
•	Market Street Plaid																										
	Veronnet																										
•	Zero																										
•	Chandigar																										
•	Pelle																										
•	Pelle Extra																										
	Spotted leather																										
	Artemidor																										
	Pucci Cotton / Velvet																										
	Hide																										

Code description

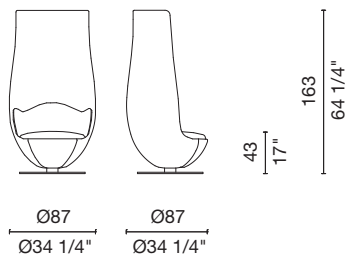

		cat. A	cat. B	cat. C	cat. D	cat. E	cat. E1	cat. G	cat. G2	fabric lmt	leather sqmt
TL_1	Swivel armchair	8.170	8.425	8.580	8.745	9.735	10.335	11.230	11.905	8,8	16,5

Armchair with a fluid and continuous structure made of bent massive beech wood planks.

Structure

bent natural beech heartwood, oil-finishes



Code description



36
14
70
27 1/2"

82
32 1/4"

103
40 1/2"

		Price
MN_30	Small armchair	6.165

Cushions

Series of cushions with removable cover to complete armchairs and sofas, available in different sizes. Removable cover in fabrics and leathers of the collection.



Padding

acrylic fibre

Cover

removable in fabric and leather

	A	A _o	B	B _o	C				D			E				E ₁	G	G ₂	V	
•	Phill																			
•	Trame																			
•	Vancouver																			
	Sorrento		Sorrento rigato																	
•	Ecopelle																			
•	Trentino Stretto																			
•	Vancouver																			
	Ambro																			
•	Blelastico Color																			
	Blelastico Optical																			
•	Brescon																			
•	Conda																			
•	Madrid																			
•	Oceanic																			
•	Vancouver																			
•	Baltimore Plus Eco																			
•	Hallingdal 2																			
•	Panno																			
•	Steelcut Trio																			
•	Deft Velvet																			
•	Dunmore Plaid																			
•	Hardwick Plaid																			
•	Hero 2																			
•	Ivyside Herringbone																			
•	Market Street Plaid																			
•	Veronnet																			
•	Zero																			
•	Chandigar																			
•	Pelle																			
•	Pelle Extra																			
•	Spotted leather																			
•	Artemidor																			
	Pucci Cotton / Velvet																			
	Hilde																			

Code description



40
15 3/4"

	cat. A	cat. B	cat. C	cat. D	cat. E	cat. E1	cat. G	cat. G2	Artemidor	fabric lmt	leather sqmt
CM_40 Cushion	195	220	245	285	420	590	420	475	675	1,3	0,85



50
19 3/4"

	cat. A	cat. B	cat. C	cat. D	cat. E	cat. E1	cat. G	cat. G2	Artemidor	fabric lmt	leather sqmt
CM_50 Cushion	245	265	285	330	465	710	465	525	885	1,56	1,2



60
23 3/4"

	cat. A	cat. B	cat. C	cat. D	cat. E	cat. E1	cat. G	cat. G2	Artemidor	fabric lmt	leather sqmt
CM_60 Cushion	300	320	340	390	525	825	525	590	1.010	1,9	1,6



70
27 1/2"

	cat. A	cat. B	cat. C	cat. D	cat. E	cat. E1	cat. G	cat. G2	Artemidor	fabric lmt	leather sqmt
CM_70 Cushion	400	425	445	490	650	940	680	755	1.330	2,16	3

chairs, stools and armchairs

01 Chair	<i>Shiro Kuramata</i>	162
Alodia	<i>Todd Bracher</i>	163
Bac	<i>Jasper Morrison</i>	164
Cap Chair 2	<i>Jasper Morrison</i>	165
Fronzoni '64	<i>AG Fronzoni</i>	166
Hi Pad	<i>Jasper Morrison</i>	167
Juli Plastic	<i>Werner Aisslinger</i>	169
Juli Soft	<i>Werner Aisslinger</i>	172
Lotus (Low, Medium, High)	<i>Jasper Morrison</i>	175
Lud'ina	<i>Patricia Urquiola</i>	182
Morrison Stool	<i>Jasper Morrison</i>	184
Newood	<i>BrogliatoTraverso</i>	186
Newood Light	<i>BrogliatoTraverso</i>	188
O-Cap	<i>Jasper Morrison</i>	190
Peg Chair	<i>Nendo</i>	191
Rainbow Chair	<i>Patrick Norguet</i>	192
Ribbon	<i>Nendo</i>	193
S-Chair	<i>Tom Dixon</i>	194
San Siro	<i>Jasper Morrison</i>	195
San Siro Plus	<i>Jasper Morrison</i>	196
Tate Color	<i>Jasper Morrison</i>	197
Tate Soft	<i>Jasper Morrison</i>	201
Tate Wood	<i>Jasper Morrison</i>	206

All items manufactured with polyurethane foam (moulded or in multidensity) correspond to Californian Technical Bulletin 117 - 2013, Section A part 1 and Section D part 2.

Following items can also be produced by request with polyurethane foams in accord to British Standard BS 5852 – 1982 part 2: Bac (seat only), Hi Pad, Lotus (Low Medium High), Morrison Stool (upholstered version), Ribbon, Tate.

Recommended fabrics and leathers for cover are indicated on proper schedule: LIST OF FABRICS at the end of the price list.

Armchair with armrests characterised by a very light volume, with metal structure and padded seat with fixed cover in leather.

**Structure**

iron tube

Structure finish

407 chromed

matt painted

04 black

Seat

beech plywood with elastic belts

Seat padding

polyurethane foam

Seat cover

fixed in leather G

Feet

felt pads

Code description

65
25 1/2"58
22 3/4"

75

29 1/2"

45.5

18"

		cat. G	leather sqmt
PC_22	Chair with armrests and lacquered base	2.810	1
PC_22C	Chair with armrests and chromed base	4.210	1

Stackable stool available in two different heights, with structure made of metal tube and seat made of laser-cut metal sheet.



Structure

metal tube

Seat

laser-cut metal plate

Finish

matt varnished



01 white

04 black

71 mud

Feet

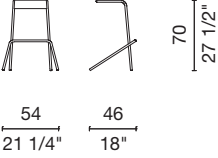
black polypropylene

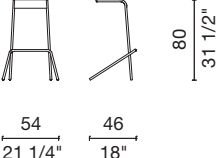
Code	description	Price
 	LD_1 Low stool	505
 	LD_2 High stool	640

Chair made of massive ash wood with seat available in the same finish as the structure or with fixed upholstery in fabric or leather.



Structure

solid ash

Structure finish

- 113 bleached ash
- 116 oak-stained ash
- 112 black-stained ash
- 118 blue Shanghai aniline stained ash

Wooden seat

ash veneered beech plywood, same finish as the structure

Upholstered seat

back in ash veneered beech plywood, same finish as the structure
front in polyurethane foam with fixed upholstery in fabric or leather

Feet

black polypropylene

Note

118 Shanghai blue finish cannot be used on upholstered chairs

	A	A ₀		B	B ₀		C			D		E				E ₁	G	G ₂	V	
●	Phill																			
●	Trame																			
●	Vancouver																			
	Sorrento																			
	Sorrento rigato																			
●	Ecopelle																			
	Trentino Stretto																			
●	Vancouver																			
	Ambro																			
	Blelastico Color																			
	Blelastico Optical																			
●	Brecon																			
	Gorda																			
●	Madrid																			
●	Oceanic																			
●	Vancouver																			
	Baltimore Plus Eco																			
●	Hallingdal 2																			
●	Panno																			
●	Steelcut Trio																			
	Delft Velvet																			
●	Dunmore Plaid																			
●	Hardwick Plaid																			
●	Hero 2																			
●	Ivyside Herringbone																			
●	Market Street Plaid																			
	Veronnet																			
●	Zero																			
	Chandigar																			
●	Pelle																			
●	Pelle Extra																			
	Spotted leather																			
	Attenidor																			
	Pucci Cotton / Velvet																			
	Hilde																			

Code description



45,5
18"
73
28 3/4"

52,5
20 3/4"
51
20"

		Price
BAC3	Chair – seat and structure in wood	1.000



45,5
18"
73
28 3/4"

52,5
20 3/4"
51
20"

		cat. A	cat. B	cat. C	cat. D	cat. E	cat. E1	cat. G	cat. G2	fabric lmt	leather sqmt
BAC3R	Chair – structure in wood, covered seat	1.100	1.130	1.155	1.180	1.200	1.220	1.275	1.295	1	1,2

Small armchair available in two heights, completely covered with leather.



Armchair structure

metal rod and tube, epoxy powder varnished in black colour

Seat

polyurethane foam with plywood element and elastic belts

Cover

fixed in hide

Base

solid ash wood with self-blocking sphere or feet in black plastic

Colour stitching

red Bulgaro thread

	A	A ₀	B	B ₀	C		D		E				E ₁	G	G ₂	V																			
Phill	Trame	Vancouver	Sorrento	Sorrento rigato	Ecopelle	Trentino Stretto	Vancouver	Ambro	Bielastico Color	Bielastico Optical	Brecon	Corda	Madrid	Oceanic	Vancouver	Baltimora Plus Eco	Hallingdal 2	Panno	Steelcut Trio	Delft Velvet	Dunmore Plaid	Hardwick Plaid	Hero 2	Ivyside Herringbone	Market Street Plaid	Veronnet	Zero	Chandigar	Pelle	Pelle Extra	Spotted leather	Artemidor	Pucci Cotton / Velvet	Hide	●

Code description



46/80
18"-31 1/2"

58
22 3/4"

57
22 1/2"

CAP2CP Small armchair in hide

Price	leather sqmt
2.930	3,2



39/73
15 1/4"-28 3/4"

58
22 3/4"

56,5
22 1/4"

CAP2CPB Conference small armchair in hide

Price	leather sqmt
2.930	3,2

Chair characterised by a great geometric rigour, with structure made of square metal tube and wooden seat.



Structure

square metal tube

Structure finish

matt varnished
01 white
04 black

Seat

medium-density fibre conglomerate panel

Seat finish

matt lacquered
01 white
04 black

Feet

black plastic

Code description

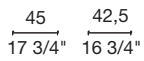
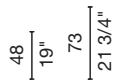

FR_11

Chair

matt
lacquer

840

Chair and stools with stainless steel base and padded shell, with fixed cover in fabrics and leathers of the collection.



Structure

bent and shaped beech plywood

Padding

multi-density polyurethane foam

Base finish

435 satined stainless steel

matt varnished

01 white

04 black

71 mud

Feet

grey polyethylene on satin stainless steel and white lacquered base black polyethylene on black and mud lacquered base

Cover

fixed in fabric and leather

Fireproof test

UK CONTRACT and UK DOMESTIC: test copy available on request

Greenguard

Hi pad has been certified with Greenguard Gold

Notes

Note 1

In the fabric version, the profile is closed with a piping in the same material

In the leather version, the profile is varnished with black paint

Note 2

The Trentino Stretto (cat. B), Vancouver (cat. C) e Steelcut Trio (cat. D) fabrics are available only for the stools

	A	A _o	B	B _o	C				D		E				E ₁	G	G ₂	V	
●	Phill																		
●	Trame																		
●	Vancouver																		
	Sorrento																		
	Sorrento rigato																		
●	Ecopelle																		
	Trentino Stretto																		
●	Vancouver																		
	Ambro																		
	Bielastico Color																		
	Bielastico Optical																		
●	Brecon																		
	Corda																		
●	Madrid																		
●	Oceanic																		
○	Vancouver																		
	Baltimore Plus Eco																		
●	Hallingdal 2																		
●	Panno																		
○	Steelcut Trio																		
	Delft Velvet																		
●	Dunmore Plaid																		
●	Hardwick Plaid																		
●	Hero 2																		
●	Ivyside Herringbone																		
●	Marker Street Plaid																		
	Veromet																		
●	Zero																		
	Chandigar																		
●	Pelle																		
●	Pelle Extra																		
	Spotted leather																		
	Artemidor																		
	Pucci Cotton / Velvet																		
	Hide																		

Code description

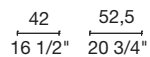
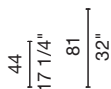

		cat. A	cat. B	cat. C	cat. D	cat. E	cat. E1	cat. G	cat. G2	fabric lmt	leather sqmt
HP_1	Chair	890	915	925	1.020	1.125	1.305	1.415	1.450	1,32	1,65

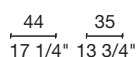

		cat. A	cat. B	cat. C	cat. D	cat. E	cat. E1	cat. G	cat. G2	fabric lmt	leather sqmt
HP_13	stool	630	650	665	685	770	815	890	890	0,61	0,83

Hi Pad

design: Jasper Morrison 1999

Code description

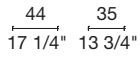

		cat. A	cat. B	cat. C	cat. D	cat. E	cat. E1	cat. G	cat. G2	fabric lmt	leather sqmt
HP_11	stool	735	755	770	805	870	925	995	1.005	0,61	0,83

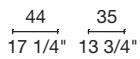

		cat. A	cat. B	cat. C	cat. D	cat. E	cat. E1	cat. G	cat. G2	fabric lmt	leather sqmt
HP_12	stool	755	770	785	815	870	925	1.005	1.020	0,61	0,83

Small armchair with armrests, with coloured plastic shell, available with different base options. The seat can be equipped with a removable anti-slip cushion.



Structure

shell made of glass fiber-reinforced polypropylene in a selection of colours

- JBI white (RAL 9010)
- JNE black (RAL 9011)
- JBL blue (RAL 5007)
- JAR vermilion (RAL 2002)
- JVE green (RAL 6016)
- JFA mud (RAL 7006)

Removable cushion

made of polyurethane foam, with the bottom covered with an anti-slip material and the top covered with Oceanic fabric C504/C506/C508/C501/C512

Column base

metal sheet and metal tube
 swivelling or swivelling with return spring in a selection of finishes
 407 chromed
 01 matt white
 04 matt black
 71 matt mud

4 wooden legs base

solid ashwood in a selection of colours
 113 bleached ash
 116 oak-stained ash
 112 black-stained ash

4-5 spokes base

4 spokes in die-cast aluminium with plastic feet, swivelling or swivelling with return spring
 5 spokes in die-cast aluminium with plastic feet or casters, swivelling with adjustable height
 in a selection of finishes
 412 polished aluminium
 01 matt white
 04 matt black
 71 matt mud

4 metal legs base

metal tube in a selection of finishes
 407 chromed
 01 matt white
 04 matt black
 71 matt mud

Sled base

metal tube in a selection of finishes
 407 chromed
 01 matt white
 04 matt black
 71 matt mud

Feet

black plastic

Casters

black plastic

Note

Chairs with column base and 4-5 spokes base are equipped with a structure under the seat in the same finish as the base for matt varnished base and in 412 polish aluminium for polish chromed base

Code description



80,5
31 3/4"
45,5
18"

66,5
26 1/4"

56
22"

		Price
JUP1	Armchair with column base	735
JUP1M	Armchair with column base and auto-return swivel base	775



80,5
31 3/4"
45,5
18"

66,5
26 1/4"

57
22 1/4"

		Price
JUP3	Armchair with 4 wooden legs	605



80,5
31 3/4"
45,5
18"

66,5
26 1/4"

56
22"

		Price
JUP4	Armchair with 4-spoke swivel base on feet	600
JUP4M	Armchair with 4-spoke auto-return swivel base on feet	645



78/86
30 3/4" / 33 3/4"
43/51
17"/20"

66,5
26 1/4"

65,5
25 3/4"

		Price
JUP5H	Armchair with 5-spoke swivel base on feet and adjustable height	675



78/86
30 3/4" / 33 3/4"
43/51
17"/20"

66,5
26 1/4"

65,5
25 3/4"

		Price
JUP5HR	Armchair with 5-spoke swivel base on casters and adjustable height	730

Code description



66,5
26 1/4"

57
22 1/4"

80,5
31 3/4"

45,5
18"

		Price
JUP6	Armchair with 4 metal legs	410



66,5
26 1/4"

58
22 3/4"

80,5
31 3/4"

45,5
18"

		Price
JUP7	Armchair with sled base	420



35
13 3/4"

39,5
15 1/2"

3
1 1/4"

		cat. C	fabric lmt
JUPX	Removable seat cushion	105	0,5

Small armchair with armrests made of padded plastic, with fixed cover in fabric, available with different base options.



Structure

shell made of glass fiber-reinforced polypropylene

Padding

polyurethane foam with fixed upholstery in a selection of fabrics of the collection

Column base

metal sheet and metal tube
swivelling or swivelling with return spring in a selection of finishes
407 chromed
01 matt white
04 matt black
71 matt mud

4 wooden legs base

solid ashwood in a selection of colours
113 bleached ash
116 oak-stained ash
112 black-stained ash

4-5 spokes base

4 spokes in die-cast aluminium with plastic feet, swivelling or swivelling with return spring
5 spokes in die-cast aluminium with plastic feet or casters, swivelling with adjustable height in a selection of finishes
412 polished aluminium
01 matt white
04 matt black
71 matt mud

4 metal legs base

metal tube in a selection of finishes
407 chromed
01 matt white
04 matt black
71 matt mud

Sled base

metal tube in a selection of finishes
407 chromed
01 matt white
04 matt black
71 matt mud

Feet

black plastic

Casters

black plastic

Note

Chairs with column base and 4-5 spokes base are equipped with a structure under the seat in the same finish as the base for matt varnished base and in 412 polish aluminium for polish chromed base

	A	A _o		B	B _o	C			D			E			E _i	G	G _s	V																			
Phill	Trame	Vancouver	Sorrento	Sorrento rigato	Ecopelle	Trentino Stretto	Vancouver	Ambro	Bielastico Color	Bielastico Optical	Brecon	Corda	Madrid	Oceanic	Vancouver	Baltimore Plus Eco	Hallingdal 2	Panno	Steelcut Trib	Delft Velvet	Dunmore Plaid	Hardwick Plaid	Hero 2	Ivyside Herringbone	Market Street Plaid	Veromet	Zero	Chandigar	Pelle	Pelle Extra	Spotted leather	Artemidor	Pucci Cotton / Velvet	Hide			
	•	•				•					•	•	•		•	•	•						•														

Code description

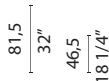

66,5 26 1/4"
58 22 3/4"

		cat. A	cat. B	cat. C	cat. D	cat. E	fabric lmt
JUS1	Armchair with column base	1.290	1.350	1.420	1.555	1.710	1,5
JUS1M	Armchair with column base and auto-return swivel base	1.325	1.390	1.475	1.615	1.775	1,5

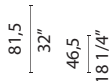

66,5 26 1/4"
57 22 1/4"

		cat. A	cat. B	cat. C	cat. D	cat. E	fabric lmt
JUS3	Armchair with 4 wooden legs	1.030	1.090	1.150	1.285	1.415	1,5

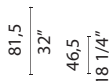

66,5 26 1/4"
56 22"

		cat. A	cat. B	cat. C	cat. D	cat. E	fabric lmt
JUS4	Armchair with 4-spoke swivel base on feet	1.080	1.130	1.210	1.320	1.465	1,5
JUS4M	Armchair with 4-spoke auto-return swivel base on feet	1.105	1.155	1.240	1.355	1.500	1,5

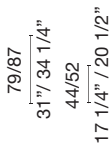

66,5 26 1/4"
65,5 25 3/4"

		cat. A	cat. B	cat. C	cat. D	cat. E	fabric lmt
JUS5H	Armchair with 5-spoke swivel base on feet and adjustable height	1.170	1.240	1.305	1.440	1.585	1,5

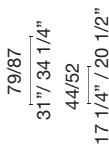

66,5 26 1/4"
65,5 25 3/4"

		cat. A	cat. B	cat. C	cat. D	cat. E	fabric lmt
JUS5HR	Armchair with 5-spoke swivel base on casters and adjustable height	1.180	1.250	1.315	1.455	1.605	1,5

Code description



66,5 26 1/4"
57 22 1/4"

81,5 32"
46,5 18 1/4"

	cat. A	cat. B	cat. C	cat. D	cat. E	fabric lmt
JUS6 Armchair with 4 metal legs	900	945	1.010	1.130	1.270	1,5



66,5 26 1/4"
58 22 3/4"

81,5 32"
46,5 18 1/4"

	cat. A	cat. B	cat. C	cat. D	cat. E	fabric lmt
JUS7 Armchair with sled base	920	975	1.045	1.155	1.295	1,5

Collection of seating units consisting of low, medium and high small armchairs, with or without armrests, with swivelling five-spoke base, with or without casters, and fixed cover in fabric or leather.



Armchair structure

beech plywood

Padding

multi-density polyurethane foam
polyurethane foam cushions hot-pressed with cover, elastic belts

Base

5 spokes, in die-cast aluminium
swivel
swivel and tilting
swivel tilting ad with adjustable height

Base and armrest finish

412 polished aluminium

matt varnished
04 black

Feet

white plastic for chromed base
black plastic for matt lacquered base

Casters

plastic caster suitable for semiorbide surfaces

Cover

fixed in fabric and leather
Steelcut Trio fabric (cat. D) is not available for Lotus High

Resistance test

LOTUS collection with a five-spoke base has been tested following these regulations
- ANSI BIFMA X5.1-2002,
- EN 1728:2000- UNI EN 15373:2007 Level 3
- EN 1335:2000
Test copies available on request.

Fireproof test

UK CONTRACT: BS7176
UK DOMESTIC: BS 5852 crib.5

Greenguard



Lotus (Low, Medium, High) has been certified with Greenguard Gold



Caption



- with casters
- with armrests
- △ swivel
- tilting
- variable height tilting movement



	A	A ₀	B	B ₀	C		D	E				E ₁	G	G ₂	V
Phill															
Trame	●														
Vancouver	●														
Sorrento															
Sorrento rigato															
Ecopelle	●														
Trentino Stretto															
Vancouver	●														
Ambro															
Bielastico Color															
Bielastico Optical															
Biecon	●														
Corda															
Madrid	●														
Oceanic	●														
Vancouver	●														
Baltimore Plus Eco	●														
Hallingdal 2	●														
Panno	●														
Steelcut Trio	○														
Delft Velvet															
Dunmore Plaid	●														
Hardwick Plaid	●														
Hero 2	●														
Ivyside Herringbone	●														
Market Street Plaid	●														
Veronnet															
Zero	●														
Chandigar															
Pelle	●														
Pelle Extra	●														
Spotted leather															
Artemidor															
Pucci Cotton / Velvet															
Hilde															

Code description



			40,5/83,5 - 54/97 max 16"/33" min - 21¼"/38¼" max	■ ▲	cat. A	cat. B	cat. C	cat. D	cat. E	cat. E1	cat. G	cat. G2	fabric lmt	leather sqmt
66 26"	66 26"				2.305	2.375	2.420	2.505	2.690	3.050	3.020	3.150	1,43	3,19
LS_35	Chair 5 spoke base													



			40,5/83,5 - 54/97 max 16"/33" min - 21¼"/38¼" max	■ ● ▲	cat. A	cat. B	cat. C	cat. D	cat. E	cat. E1	cat. G	cat. G2	fabric lmt	leather sqmt
66 26"	66 26"				2.690	2.770	2.820	2.890	3.120	3.520	3.425	3.590	1,43	3,19
LS_35CB	Chair 5 spoke base with armrests													

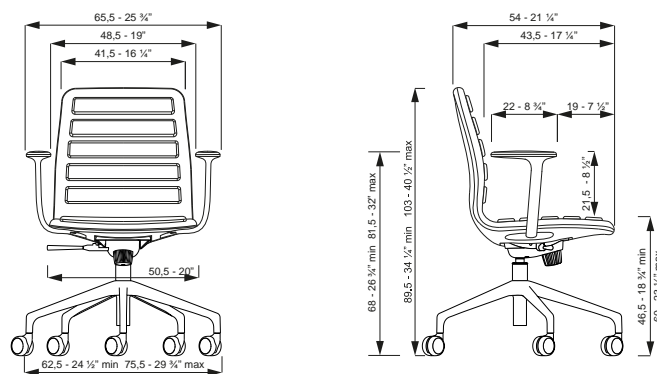
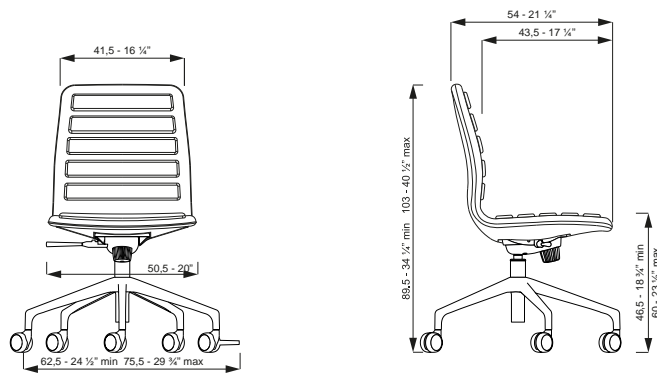
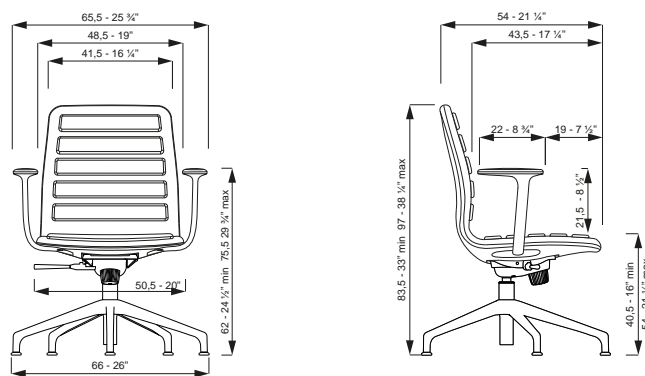
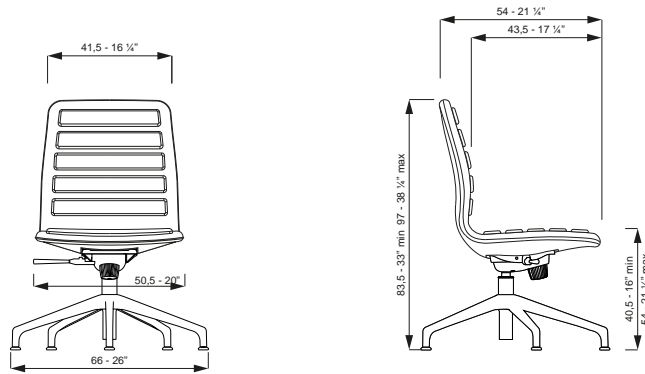

			46,5/89,5 min - 60/103 max 18 ¾"/34¼" min - 23½"/40½" max	■ ○ ▲	cat. A	cat. B	cat. C	cat. D	cat. E	cat. E1	cat. G	cat. G2	fabric lmt	leather sqmt
75,5 29¾"	75,5 29¾"				2.365	2.440	2.465	2.550	2.805	3.135	3.100	3.150	1,43	3,19
LS_35CR	Chair 5 spoke base on casters													



			46,5/89,5 min - 60/103 max 18 ¾"/34¼" min - 23½"/40½" max	■ ● ○ ▲	cat. A	cat. B	cat. C	cat. D	cat. E	cat. E1	cat. G	cat. G2	fabric lmt	leather sqmt
75,5 29¾"	75,5 29¾"				2.785	2.875	2.890	2.985	3.195	3.590	3.485	3.655	1,43	3,19
LS_35CBR	Chair 5 spoke base on casters with armrests													







			40,5/98,5 min - 54/111,5 max 116"/98¾" min - 21¼"/40" max	■ ▲	cat. A	cat. B	cat. C	cat. D	cat. E	cat. E1	cat. G	cat. G2	fabric lmt	leather sqmt
66 26"	66 26"				2.590	2.660	2.690	2.805	2.985	3.355	3.355	3.390	1,65	3,19
LS_45 Chair 5 spoke base														

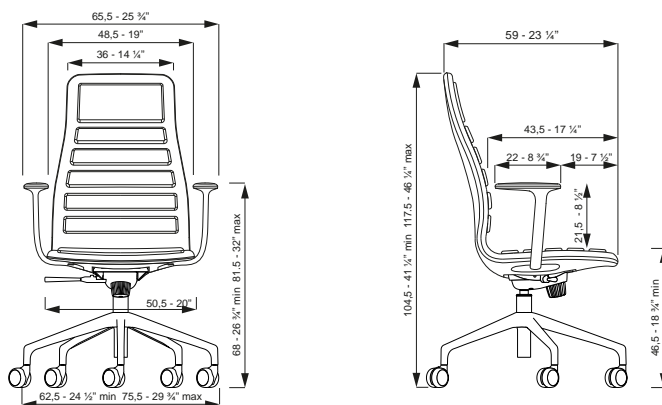
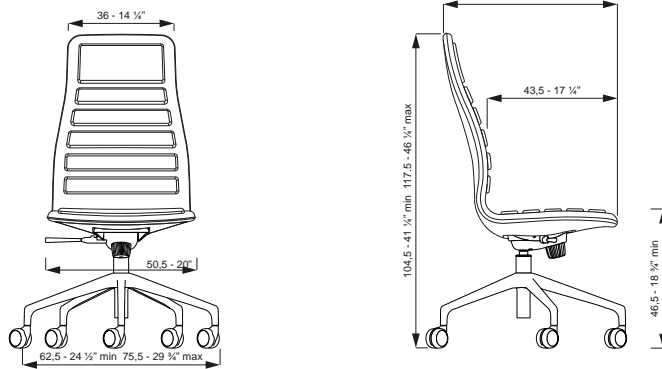
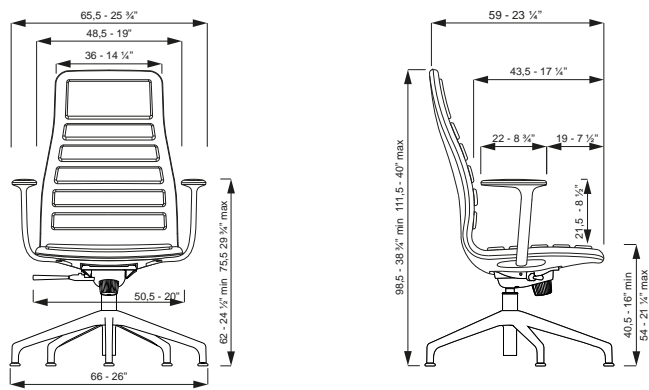
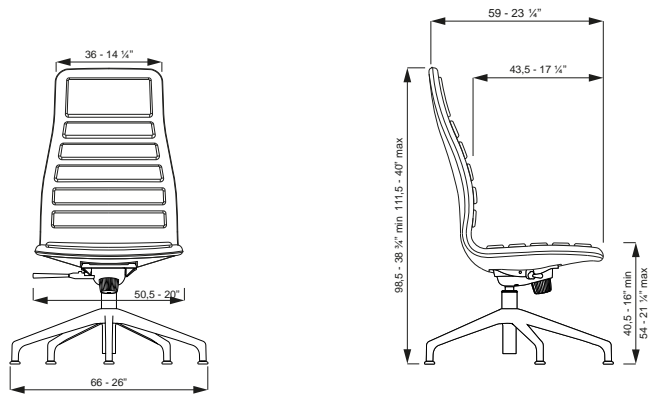

			40,5/98,5 min - 54/111,5 max 116"/98¾" min - 21¼"/40" max	■ ● ▲	cat. A	cat. B	cat. C	cat. D	cat. E	cat. E1	cat. G	cat. G2	fabric lmt	leather sqmt
66 26"	66 26"				3.020	3.110	3.135	3.345	3.530	3.970	3.820	3.845	1,65	3,19
LS_45CB Chair 5 spoke base with armrests														



			46,5/104,5 min - 60/117,5 max 18¾"/41¼" min - 23½"/46¼" max	■ ○ ▲	cat. A	cat. B	cat. C	cat. D	cat. E	cat. E1	cat. G	cat. G2	fabric lmt	leather sqmt
75,5 29¾"	75,5 29¾"				2.690	2.770	2.805	2.890	3.075	3.470	3.425	3.500	1,65	3,19
LS_45CR Chair 5 spoke base on casters														



			46,5/104,5 min - 60/117,5 max 18¾"/41¼" min - 23½"/46¼" max	■ ● ○ ▲	cat. A	cat. B	cat. C	cat. D	cat. E	cat. E1	cat. G	cat. G2	fabric lmt	leather sqmt
75,5 29¾"	75,5 29¾"				3.110	3.195	3.225	3.345	3.530	3.970	3.880	3.915	1,65	3,19
LS_45CBR Chair 5 spoke base on casters with armrests														



			40,5/19,5 min - 54/133 max 16"/47" min - 21¼"/52¼" max	■ ▲	cat. A	cat. B	cat. C	cat. D	cat. E	cat. E1	cat. G	cat. G2	fabric lmt	leather sqmt
66 26"	66 26"				3.050	3.150	3.225	3.355	3.545	4.005	3.900	3.990	2,09	3,52
LS_55 Chair 5 spoke base														

			40,5/19,5 min - 54/133 max 16"/47" min - 21¼"/52¼" max	■ ● ▲	cat. A	cat. B	cat. C	cat. D	cat. E	cat. E1	cat. G	cat. G2	fabric lmt	leather sqmt
66 26"	66 26"				3.425	3.530	3.675	3.805	4.015	4.520	4.365	4.440	2,09	3,52
LS_55CB Chair 5 spoke base with armrests														

			46,5/125,5 min - 60/139 max 18¾"/49½" min - 23½"-54¾" max	■ ○ ▲	cat. A	cat. B	cat. C	cat. D	cat. E	cat. E1	cat. G	cat. G2	fabric lmt	leather sqmt
75,5 29¾"	75,5 29¾"				3.110	3.195	3.285	3.425	3.655	4.105	3.915	3.990	2,09	3,52
LS_55CR Chair 5 spoke base on casters														

			46,5/125,5 min - 60/139 max 18¾"/49½" min - 23½"-54¾" max	■ ● ○ ▲	cat. A	cat. B	cat. C	cat. D	cat. E	cat. E1	cat. G	cat. G2	fabric lmt	leather sqmt
75,5 29¾"	75,5 29¾"				3.520	3.620	3.760	3.900	4.090	4.620	4.455	4.520	2,09	3,52
LS_55CBR Chair 5 spoke base on casters with armrests														

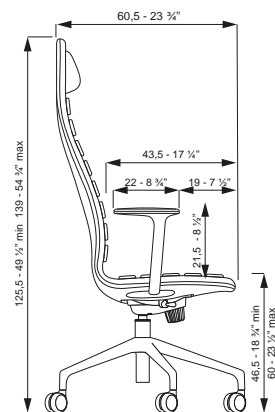
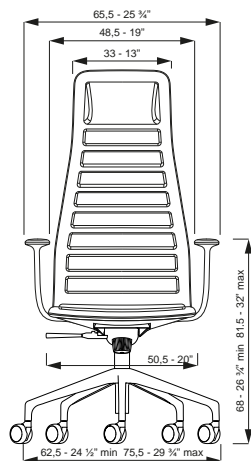
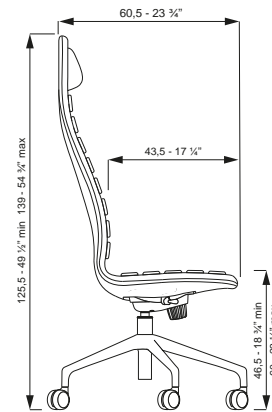
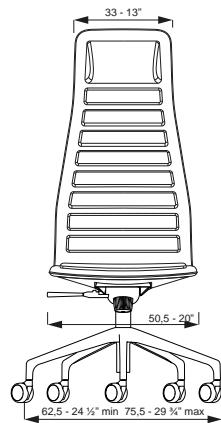
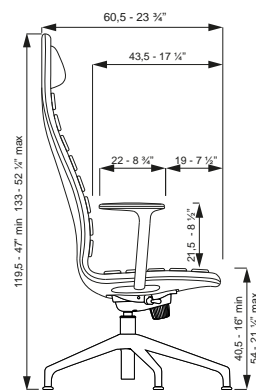
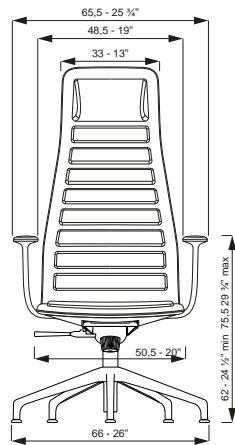
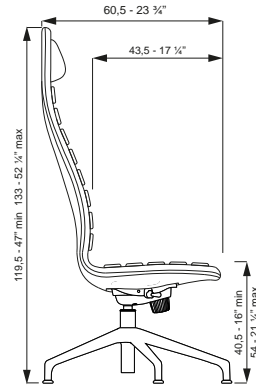
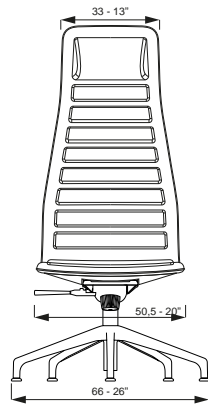

Small armchair with structure made of recycled and recyclable plastic material, available with different base solutions and removable cover in a selection of fabrics and leathers from the collection.



Structure

shell in recycled and recyclable linear polyethylene

Padding

polyurethane foam and polyester fiber

Cover

removable in fabric and leather
upon request, the upholstery for each item can be ordered separately

4 wooden legs base

4 legs in solid ashwood

4 wooden legs base finish

116 oak-stained ash
112 black-stained ash

5 spokes base

5 metal spokes with feet or casters

5 spokes base finish

412 polished aluminium
01 matt white
04 matt black

Feet

black plastic

	A	A ₀	B	B ₀	C		D		E				E ₁	G	G ₂	V																		
Phill																																		
•	•	•	•	•	•	•	•	•	•	•	•	•	•	•	•	•	•	•																
	Trame	Vancouver	Sorrento	Sorrento rigato	Ecopelle	Trentino Stretto	Vancouver	Ambro	Bielastico Color	Bielastico Optical	Brecon	Corda	Madrid	Oceanic	Vancouver	Baltimore Plus Eco	Hallingdal 2	Panno	Steelcut Trib	Delft Velvet	Dunmore Plaid	Hardwick Plaid	Hero 2	Ivyside Herringbone	Market Street Plaid	Veronnet	Zero	Chandigar	Pelle	Pelle Extra	Spotted leather	Artemidor	Pucci Cotton / Velvet	Hide

Code description

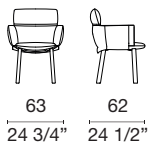

	cat. A	cat. B	cat. C	cat. D	cat. E	cat. E1	cat. G	cat. G2	Artemidor	fabric lmt	leather sqmt
LUC3 Small armchair with 4 wooden spokes base	1.625	1.725	1.820	2.015	2.215	2.925	2.575	2.695	3.355	2,64	4,73

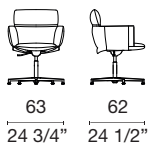

	cat. A	cat. B	cat. C	cat. D	cat. E	cat. E1	cat. G	cat. G2	Artemidor	fabric lmt	leather sqmt
LUC5 Small armchair with 5-spokes base on feet	1.480	1.580	1.670	1.855	2.045	2.740	2.385	2.515	3.205	2,64	4,73

Code description



63
24 3/4"

62
24 1/2"

83 / 93
32 3/4" / 36 1/2"
45 / 55
17 3/4" / 21 1/2"

		cat. A	cat. B	cat. C	cat. D	cat. E	cat. E1	cat. G	cat. G2	Artemidor	fabric lmt	leather sqmt
LUC5R	Small armchair with 5-spokes base on casters	1.510	1.610	1.700	1.890	2.085	2.780	2.430	2.560	3.245	2,64	4,73

Stool available in three heights with stainless steel base and wooden seat, ash veneered or padded with fixed upholstery in fabrics or leathers from the collection.



Seat finish

- 113 bleached ash
- 116 oak-stained ash
- 112 black-stained ash

Upholstered seat

inside in beech plywood and birch covered with multi-density polyurethane foam

Cover

fixed in fabric and leather

Base finish

435 satined stainless steel

matt varnished

- 01 white
- 04 black
- 71 mud

Feet

grey polypropylene

Note

In the fabric version, the profile is closed with a piping in the same material
 In the leather version, the profile is varnished with black paint

	A	A ₀		B	B ₀	C				D			E				E ₁	G	G ₂	V			
•	Phill																						
•	Trame																						
•	Vancouver																						
	Sorrento																						
	Sorrento rigato																						
•	Ecopelle																						
	Trentino Stretto																						
•	Vancouver																						
	Ambro																						
	Bielastico Color																						
	Bielastico Optical																						
•	Brecon																						
	Cordia																						
•	Madrid																						
•	Oceanic																						
•	Vancouver																						
	Baltimore Plus Eco																						
•	Hallingdøl 2																						
•	Panno																						
•	Steelcut Trio																						
	Delft Velvet																						
•	Dummore Plaid																						
•	Hardwick Plaid																						
•	Hero 2																						
•	Ivyside Herringbone																						
•	Market Street Plaid																						
	Veronnet																						
•	Zero																						
	Chandigar																						
•	Pelle																						
•	Pelle Extra																						
	Spotted leather																						
	Atramiðar																						
	Pucci Cotton / Velvet																						
	Hide																						

Code description

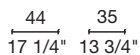

		cat. A	cat. B	cat. C	cat. D	cat. E	cat. E1	cat. G	cat. G2	fabric lmt	leather sqmt
HP_13B	Stool with upholstered seat	630	650	665	675	755	815	890	890	0,61	0,83

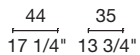

											Price
HP_13BL	Stool with wooden seat										535

Morrison Stool

design: Jasper Morrison 2003

Code description



44 35
17 1/4" 13 3/4"

	cat. A	cat. B	cat. C	cat. D	cat. E	cat. E1	cat. G	cat. G2	fabric lmt	leather sqmt
HP_11B Stool with upholstered seat	735	755	770	785	830	905	995	1.005	0,61	0,83



44 35
17 1/4" 13 3/4"

										Price
HP_11BL Stool with wooden seat										565



44 35
17 1/4" 13 3/4"

	cat. A	cat. B	cat. C	cat. D	cat. E	cat. E1	cat. G	cat. G2	fabric lmt	leather sqmt
HP_12B Stool with upholstered seat	755	770	785	805	870	925	1.005	1.020	0,61	0,83



44 35 32
17 1/4" 13 3/4"

										Price
HP_12BL Stool with wooden seat										630

Stackable chair and stools in two heights with structure made of solid ash wood and seat in the same finish or padded with fixed cover in fabric or leather.



Structure

solid ash

Finish

- 113 bleached ash
- 116 oak-stained ash
- 112 black-stained ash
- 118 blue Shanghai aniline stained ash

Wooden seat

ash veneered beech plywood, same finish as the structure

Upholstered seat

polyurethane foam with fixed upholstery in a selection of fabrics and leathers of the collection

Feet

black nylon

Trolley

metal tube, matt black-coloured paint

Notes

Note 1

The chair is equipped with four black nylon spacers beneath the seat

Note 2

Seats stackable: maximum 4 chairs

Note 3

Seats stackable on trolley: maximum 12 chairs

Note 4

The trolley is equipped with side padding to protect the chairs

Note 5

Footrest on the front made of brushed stainless steel

	A	A ₀	B	B ₀	C	D	E	E ₁	G	G ₂	V
•	Phill										
•	Trame										
•	Vancouver										
	Sorrento										
	Sorrento rigato										
•	Ecopelle										
•	Trentino Stretto										
•	Vancouver										
	Ambro										
•	Bielastico Color										
	Bielastico Optical										
•	Brecon										
	Corda										
•	Madrid										
•	Oceanic										
•	Vancouver										
	Baltimora Plus Eco										
•	Hallingdal 2										
•	Panno										
•	Steelcut Trio										
•	Delft Velvet										
•	Dunmore Plaid										
•	Hardwick Plaid										
•	Hero 2										
•	Ivyside Herringbone										
•	Market Street Plaid										
•	Veronnet										
•	Zero										
	Chandigar										
•	Pelle										
•	Pelle Extra										
	Spotted leather										
	Artemidor										
	Pucci Cotton / Velvet										
	Hide										

Code description

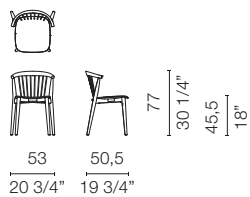

	Price
NW_1 Chair with wooden seat	800

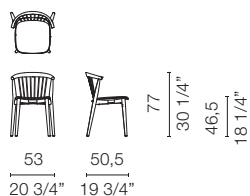

	cat. A	cat. B	cat. C	cat. D	cat. E	cat. G	cat. G ₂	fabric lmt	leather sqmt
NW_1T Chair with upholstered seat	890	905	935	985	1.045	1.210	1.275	0,6	0,8

Code description

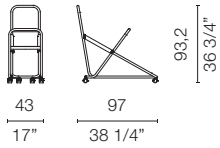

	Price
CAR_2 Trolley for chairs	725

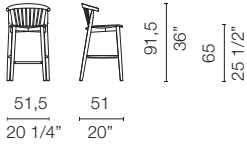

	Price
NW_11 Low stool with wooden seat	1.030

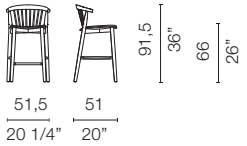

	cat. A	cat. B	cat. C	cat. D	cat. E	cat. G	cat. G2	fabric lmt	leather sqmt
NW_11T Low stool with upholstered seat	1.210	1.250	1.290	1.345	1.430	1.630	1.690	0,6	0,8

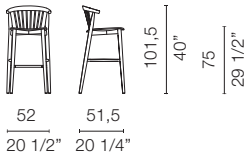

	Price
NW_12 High stool with wooden seat	1.125

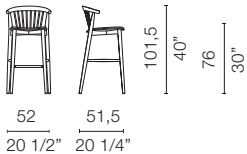

	cat. A	cat. B	cat. C	cat. D	cat. E	cat. G	cat. G2	fabric lmt	leather sqmt
NW_12T High stool with upholstered seat	1.240	1.280	1.315	1.365	1.455	1.665	1.725	0,6	0,8

Stackable chair and stools in two heights with structure made of solid ash wood and seat in the same finish or padded with fixed cover in fabric or leather.



Structure

solid ash

Finish

- 113 bleached ash
- 116 oak-stained ash
- 112 black-stained ash
- 118 blue Shanghai aniline stained ash

Wooden seat

ash veneered beech plywood, same finish as the structure

Upholstered seat

polyurethane foam with fixed upholstery in a selection of fabrics and leathers of the collection

Feet

black nylon

Trolley

metal tube, matt black-coloured paint

Notes

Note 1

The chair is equipped with four black nylon spacers beneath the seat

Note 2

Seats stackable: maximum 4 chairs

Note 3

Seats stackable on trolley: maximum 12 chairs

Note 4

The trolley is equipped with side padding to protect the chairs

Note 5

Footrest on the front made of brushed stainless steel

	A	A ₀	B	B ₀	C	D	E	E ₁	G	G ₂	V
•	Phill										
•	Trame										
•	Vancouver										
	Sorrento										
	Sorrento rigato										
•	Ecopelle										
•	Trentino Stretto										
•	Vancouver										
	Ambro										
•	Bielastico Color										
	Bielastico Optical										
•	Brecon										
	Corda										
•	Madrid										
•	Oceanic										
•	Vancouver										
	Baltimora Plus Eco										
•	Hallingdal 2										
•	Panno										
•	Steelcut Trio										
•	Delft Velvet										
•	Dunmore Plaid										
•	Hardwick Plaid										
•	Hero 2										
•	Ivyside Herringbone										
•	Market Street Plaid										
•	Veronnet										
•	Zero										
	Chandigar										
•	Pelle										
•	Pelle Extra										
	Spotted leather										
	Artemidor										
	Pucci Cotton / Velvet										
	Hide										

Code description



77
30 1/4"
45,5
18"

53
20 3/4"

50,5
19" 3/4"

Code	Description	Price
NWL1	Chair with wooden seat	720



77
30 1/4"
46,5
18 1/4"

53
20 3/4"

50,5
19" 3/4"

		cat. A	cat. B	cat. C	cat. D	cat. E	cat. G	cat. G ₂	fabric lmt	leather sqmt
NWL1T	Chair with upholstered seat	830	845	870	930	985	1.155	1.210	0,6	0,8

Code description

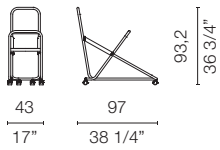

	Price
CAR_2 Trolley for chairs	725

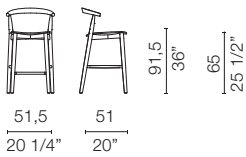

	Price
NWL11 Low stool with wooden seat	975

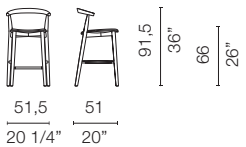

	cat. A	cat. B	cat. C	cat. D	cat. E	cat. G	cat. G2	fabric lmt	leather sqmt
NWL11T Low stool with upholstered seat	1.155	1.190	1.235	1.285	1.365	1.565	1.635	0,6	0,8

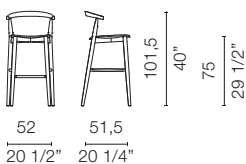

	Price
NWL12 High stool with wooden seat	1.070

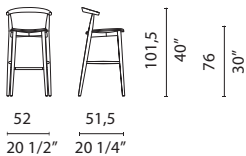

	cat. A	cat. B	cat. C	cat. D	cat. E	cat. G	cat. G2	fabric lmt	leather sqmt
NWL12T High stool with upholstered seat	1.180	1.215	1.270	1.305	1.395	1.605	1.670	0,6	0,8

Small armchair with die-cast aluminium five-spoke base, with or without casters, with fixed upholstery in saddle leather.



Frame

metal rods powder coated

Seat

plywood seat and elastic belt covered in polyurethane foam

Back padding

polyurethane foam

Cover

fixed in hide

Base

5-spoke die-cast aluminium with or without casters, swivel with adjustable height

Base finish

412 polished aluminium

matt varnished

04 black

Feet

white plastic for chrome a
black plastic for black base

Castors

plastic casters suitable for semi-soft surfaces

Colour stitching

red Bulgaro thread

Note

Gas lift lever is always in polish chromed finish

	A	A ₀		B	B ₀		C		D		E		E ₁	G	G ₂	V			
Phill																			
Trame																			
Vancouver																			
Sorrento																			
Sorrento rigato																			
Ecoppelle																			
Trentino Stretto																			
Vancouver																			
Ambro																			
Bielastico Color																			
Bielastico Optical																			
Brecon																			
Corda																			
Madrid																			
Oceanic																			
Vancouver																			
Baltimore Plus Eco																			
Hallingdal 2																			
Panno																			
Steelcut Trio																			
Delft Velvet																			
Dunmore Plaid																			
Hardwick Plaid																			
Hero 2																			
Ivyside Herringbone																			
Market Street Plaid																			
Veronnet																			
Zero																			
Chandigar																			
Pelle																			
Pelle Extra																			
Spotted leather																			
Artemidor																			
Pucci Cotton / Velvet																			
Hide																			●

Code description



66
26"



63
24"¾

75 - 88
29½" - 34½"
41 - 54
16¼" - 21¼"

OCP5P	hide armchair 5-spoke base on feet with adjustable height	Hide	leather sqmt
		2.995	2,2



73
28"¾



70
27"½

79,5 - 92,5
31¼" - 36½"
45,5 - 58,5
18" - 23"

OCP5RP	hide armchair 5-spoke base on casters with adjustable height	Hide	leather sqmt
		3.080	2,2

Low and curved chair, with legs made of massive ash wood and fixed upholstery in a selection of fabrics and leathers from the collection.



Structure

seat in a co-injection of stiff polyurethan and soft foam

Seat

polyurethane with element in medium-density wooden fiber

Cover

fixed in fabric and leather

Base

solid ash with self-blocking sphere casters

Base finish

- 113 bleached ash
- 116 oak-stained ash
- 112 black-stained ash

Notes

Note 1

Seat and backrest free matching with selected fabrics and leathers:

for backrest and seat in different fabrics = highest category price to be calculated

for backrest in leather and seat in fabric or viceversa = highest category price to be calculated

Note 2

Thread in the same fabric or leather colour

	A	A ₀		B	B ₀		C			D			E				E ₁	G	G ₂	V	
●	Phill																				
●	Trame																				
	Vancouver																				
	Sorrento																				
	Sorrento rigato																				
	Ecopelle																				
	Trentino Stretto																				
●	Vancouver																				
	Ambro																				
	Bielastico Color																				
	Bielastico Optical																				
	Brecon																				
	Cordia																				
●	Madrid																				
●	Oceanic																				
●	Vancouver																				
	Baltimore Plus Eco																				
●	Hallingdal 2																				
●	Panno																				
	Steelcut Trio																				
	Delft Velvet																				
●	Dummore Plaid																				
●	Hardwick Plaid																				
●	Hero 2																				
●	Ivyside Herringbone																				
●	Market Street Plaid																				
	Veronnet																				
●	Zero																				
	Chandigar																				
●	Pelle																				
●	Pelle Extra																				
	Spotted leather																				
	Atremidor																				
	Pucci Cotton / Velvet																				
	Hide																				

Code description

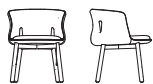

47/74
18 1/2" - 29 1/4"

58
22 3/4"

62
24 1/2"

		cat. A	cat. B	cat. C	cat. D	cat. E	cat. E1	cat. G	cat. G2	fabric lmt	leather sqmt
PEG3R	Small table armchair	2.440	2.540	2.590	2.735	2.855	2.940	2.940	2.955	2,2	2,37

Rainbow Chair

design: Patrick Norguet 2000

Chair entirely manufactured in methacrylate, with plates of different colour and thickness glued together by means of ultrasounds.



Structure

methacrylate in plates

Finish

hand-made mirror-polished

Code description

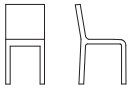

45
17 3/4"
80
31 1/2"

39
15 1/4"
51
20"

		Price
RC_1	Chair	15.270

Series of high and low stools made of laser-cut and folded up metal plate. A small magnetic cushion for the seat is also available, with fixed cover in a selection of fabrics and leathers from the collection.



Structure

metal plate

Structure finish

matt varnished
01 white
34 red
04 black
71 mud

Cushion

magnetic, with middle-density food fibre frame, padding in polyurethane foam

Cushion cover

fixed in fabric and leather

Feet and footrest

transparent plastic

	A	A ₀	B	B ₀	C		D		E				E ₁	G	G ₂	V		
●	Phill																	
●	Trame																	
●	Vancouver																	
	Sorrento																	
	Sorrento rigato																	
●	Ecopelle																	
●	Trentino Stretto																	
●	Vancouver																	
	Ambro																	
	Bielastico Color																	
	Bielastico Optical																	
●	Brecon																	
	Corda																	
●	Madrid																	
●	Oceanic																	
●	Vancouver																	
	Baltimore Plus Eco																	
●	Hallingdal 2																	
●	Panno																	
●	Steelcut Trio																	
●	Deift Velvet																	
●	Dunmore Plaid																	
●	Hardwick Plaid																	
●	Hero 2																	
●	Ivyside Herringbone																	
●	Marker Street Plaid																	
	Veronnet																	
●	Zero																	
●	Chandigar																	
●	Pelle																	
●	Pelle Extra																	
	Spotted leather																	
	Artemidor																	
	Pucci Cotton / Velvet																	
	Hide																	

Code description



77
30 1/4"

Ø37,5

Ø37,5

Ø14 3/4" Ø14 3/4"

Price

RI_1LL Lacquered high stool

800



44
17 1/4"

Ø37,5

Ø37,5

Ø14 3/4" Ø14 3/4"

Price

RI_2LL Lacquered low stool

530



3
1 1/4"

Ø32

12 1/2"

	cat. A	cat. B	cat. C	cat. D	cat. E	cat. G	cat. G2	fabric lmt	leather sqmt
RI_CU1 Cushion	310	340	355	365	415	415	425	0,45	0,8

Chair with metal structure and fixed cover in straw, wicker or in a selection of fabrics and leathers of the collection.



Structure

powder-painted steel, dark brown colour

Feet

black plastic

Cover

602 stained wicker

603 woven marsh straw

fixed in fabric and leather

	A	A ₀	B	B ₀	C				D		E					E ₁	G	G ₂	V
Phill																			
Trame																			
Vancouver																			
Sorrento																			
Sorrento rigato																			
Ecopelle																			
Trentino Stretto																			
Vancouver																			
Ambro																			
Bielastico Color																			
Bielastico Optical																			
Brecon																			
Corda																			
Maadrid																			
Oceanic																			
Vancouver																			
Baltimora Plus Eco																			
Hallingdal 2																			
Panno																			
Steelcut Trio																			
Delft Velvet																			
Dunmore Plaid																			
Hardwick Plaid																			
Hero 2																			
Ivyside Herringbone																			
Market Street Plaid																			
Veronnet																			
Zero																			
Chandigar																			
Pelle																			
Pelle Extra																			
Spotted leather																			
Attenidor																			
Pucci Cotton / Velvet																			
Hide																			

Code description



47
18 1/2"
102
40 1/4"

50 42
19 3/4" 16 1/2"

Wicker M Straw PP

TD_1 Chair in wicker or straw

1.920 2.320



47
18 1/2"
102
40 1/4"

50 42
19 3/4" 16 1/2"

		cat. B	cat. C	cat. D	cat. E	cat. E1	cat. G	cat. G2	Spotted leath V	fabric lmt	leather sqmt
TD_1T	Chair in fabric or leather	2.310	2.350	2.480	2.705	2.960	2.930	3.030	3.760	1,65	2,97

Tub armchair with a very thin structure, on feet or casters, with fixed upholstery in a selection of fabrics and leathers of the collection.



Structure

polyurethane foam with metal frame and springs, and birch plywood

Seat

polyurethane foam with metal frame and elastic belts

Cover

fixed in fabric or leather

Feet

black plastic with rubber element for ground support

Casters

black plastic

Note

Tone on tone stitching

	A	A ₀		B	B ₀		C		D		E		E ₁	G	G ₂	V
●	Phill															
●	Trame															
●	Vancouver															
	Sorrento															
	Sorrento rigato															
●	Ecopelle															
	Trentino Stretto															
●	Vancouver															
	Ambro															
	Bielastico Color															
	Bielastico Optical															
	Brecon															
●	Corda															
●	Madrid															
●	Oceanic															
●	Vancouver															
	Baltimora Plus Eco															
●	Hallingdal 2															
●	Panno															
●	Steelcut Trio															
	Delft Velvet															
	Dunmore Plaid															
●	Hardwick Plaid															
●	Hero 2															
●	Ivyside Herringbone															
●	Market Street Plaid															
	Veronnet															
●	Zero															
	Chandigar															
●	Pelle															
●	Pelle Extra															
	Spotted leather															
	Artemidor															
	Pucci Cotton / Velvet															
	Hide															

Code description



44.5
17 1/2"

76
30"

60
23 1/2"

53
20 3/4"

		cat. A	cat. B	cat. C	cat. D	cat. E	cat. E1	cat. G	cat. G2	fabric lmt	leather sqmt
MC_1	Small armchair on feet	1.595	1.710	1.790	2.030	2.215	3.000	2.205	2.475	2,6	5



46.5
18 1/4"

78
30 3/4"

58.5min-64.5max
23min-25 1/2max

53min-54max
20 3/4min-21 1/4max

		cat. A	cat. B	cat. C	cat. D	cat. E	cat. E1	cat. G	cat. G2	fabric lmt	leather sqmt
MC_1CR	Small armchair on casters	1.655	1.755	1.840	2.075	2.265	3.045	2.270	2.530	2,6	5

Tub armchair with a very thin structure, available on feet or casters. Fixed upholstery with outside in leather and inside in fabric.



Structure

polyurethane foam with metal frame and springs, and birch plywood
additional memory foam internal padding to guarantee maximum comfort

Seat

polyurethane foam with metal frame and elastic belts

Upholstery

fixed, with outside in leather and inside in a selection of fabrics

Feet

black plastic with rubber element for ground support

Casters

black plastic

Note

Tone on tone stitching

	A	A ₀		B	B ₀		C		D		E				E ₁	G	G ₂	V																
Phill	Trame	Vancouver	Sorrento	Sorrento rigato	Ecopelle	Trentino Stretto	Vancouver	Ambro	Bielastico Color	Bielastico Optical	Brecon	Corda	Madrid	Oceanic	Vancouver	Baltimora Plus Eco	Hallingdal 2	Panno	Steelcut Tito	Delft Velvet	Dunmore Plaid	Hardwick Plaid	Hero 2	Ivyside Herringbone	Market Street Plaid	Veronnet	Zero	Chandigar	Pelle	Pelle Extra	Spotted leather	Artemidor	Pucci Cotton / Velvet	Hide
	•	•					•				•				•	•							•			•	•							

Code description



44.5
17 1/2"
76
30"

60
23 1/2"

53
20 3/4"

		cat. A	cat. B	cat. C	cat. D	cat. E
MC_1B	Small armchair on casters with front in fabric and back in leather	2.045	2.115	2.155	2.250	2.325



46.5
18 1/4"
78
30 3/4"

58.5min-64.5max
23 1/4min-25 1/2max

53min-54max
20 1/4min-21 1/4max

		cat. A	cat. B	cat. C	cat. D	cat. E
MC_1BCR	Small armchair on casters with front in fabric and back in leather	1.965	2.015	2.050	2.140	2.215

Stackable chair and stools in two heights, with high or low back, with aniline painted beech plywood seat and different base options.



Shell

beech plywood

Shell finish

aniline painted in the colours:

A41 white
 A42 mud
 A43 anthracite
 A44 pumpkin
 A45 brick-red
 A46 grass-green
 A47 blue-green
 A48 prussian blue

4 metal legs base

435 satined stainless steel

matt varnished in the colours:

01 white (RAL 9010)
 71 mud (RAL 7006)
 04 black (RAL 9005)
 24 pumpkin (RAL 1024)
 16 brick red (RAL 3016)
 14 grass green (RAL 6000)
 26 blue-green (RAL 6026)
 17 prussian blue (RAL 5007)

Sled base

435 satined stainless steel

matt varnished

01 white
 04 black
 71 mud

5-spoke base

412 polished aluminium

Writing board

reclining, made of black high pressure laminate, available only with 4 metal legs base in stainless steel

Feet

black plastic

Casters

black and grey plastic with chromed crankcase

Trolley

black painted metal, on casters (front casters with brake)
 up to 8 chairs stacked
 only available for chair with 4 metal legs

Resistance test

The item has been tested following these regulations:

- ANSI BIFMA X5.1-2002,
 - EN 1728:2000- UNI EN 15373:2007 Level 2 (chair)
 - EN 1335:2000

Test copies available on request

Greenguard

Tate Color has been certified with Greenguard Gold

Note

Stackable chair:
 up to 6 pieces for sled base version
 up to 8 pieces for 4 metal legs base version

Code description



46
18
80,5
31½"

51
20" 52,5
20¾"

		Price
TC_1	Chair - 4 stainless steel legs	585
TC_10	Chair - 4 matt lacquered legs	540

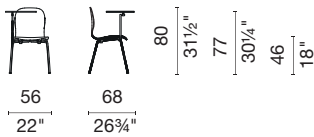
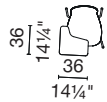

80
31½"
77
30¼"
46
18"

56
22" 68
26¾"

		Price
TC_2	Chair with writing board - 4 stainless steel legs	880



64,5
25½"
101,5
40"

43,5
17¼" 50,5
20"

		Price
TC_11	Low stool with high back - 4 stainless steel legs	675
TC_110	Low stool with high back - 4 matt lacquered legs	605



79
31"
116
45¾"

43,5
17¼" 51,5
20¾"

		Price
TC_12	High stool with high back - 4 stainless steel legs	680
TC_120	High stool with high back - 4 matt lacquered legs	610



64,5
25 1/2"
75
29 1/2"

43,5
17 1/4" 50
19 3/4"

		Price
TC_11B	Low stool with low back - 4 stainless steel legs	615
TC_11B0	Low stool with low back - 4 matt lacquered legs	565

Code description



80
31 1/2"
90,5
35 3/4"

43,5 49,5
17 1/4" 19 1/2"

		Price
TC_12B	High stool with low back - 4 stainless steel legs	640
TC_12BO	High stool with low back - 4 matt lacquered legs	565



44,5
17 1/2"
80,5
31 3/4"

54,5 52
21 1/2" 20 1/2"

		Price
TC_3	Chair - stainless steel sled base	670
TC_30	Chair - matt lacquered sled base	645



64,5
25 1/2"
100,5
39 1/2"

43,5 49
17 1/4" 19 1/4"

		Price
TC_31	Low stool with high back - stainless steel sled base	750
TC_310	Low stool with high back - matt lacquered sled base	675

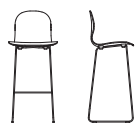

79
31"
116
45 3/4"

43,5 49
17 1/4" 19 1/4"

		Price
TC_32	High stool with high back - stainless steel sled base	760
TC_320	High stool with high back - matt lacquered sled base	680



64,5
25 1/2"
75
29 1/2"

43,5 43,5
17 1/2" 17 1/4"

		Price
TC_31B	Low stool with low back - stainless steel sled base	675
TC_31BO	Low stool with low back - matt lacquered sled base	615

Code description

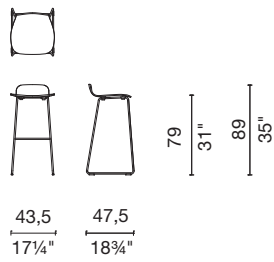

		Price
TC_32B	High stool with low back - stainless steel sled base	705
TC_32BO	High stool with low back - matt lacquered sled base	645

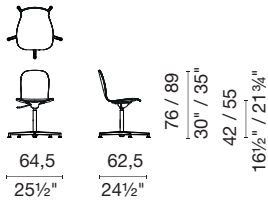

		Price
TC_5H	Chair - 5 spokes chromed base with feet	730

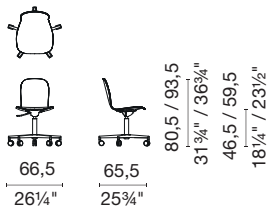

		Price
TC_5HR	Chair - 5 spokes chromed base with casters	805

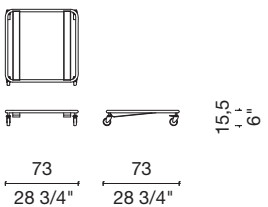

		Price
CAR_1	Trolley	495

Stackable chair and stools in two heights, with high or low back, with upholstered beech plywood seat and different base options.



Shell

beech plywood

Padding

polyurethane foam

Cover

fixed in fabric or leather

4 metal legs base

435 satined stainless steel

matt varnished in the colours:

- 01 white (RAL 9010)
- 71 mud (RAL 7006)
- 04 black (RAL 9005)
- 24 pumpkin (RAL 1024)
- 16 brick red (RAL 3016)
- 14 grass green (RAL 6000)
- 26 blue-green (RAL 6026)
- 17 prussian blue (RAL 5007)

Sled base

435 satined stainless steel

matt varnished

- 01 white
- 04 black
- 71 mud

5-spoke base

412 polished aluminium

Writing board

reclining, made of black high pressure laminate, available only with 4 metal legs base in stainless steel

Feet

black plastic

Casters

black and grey plastic with chromed crankcase

Trolley

black painted metal, on casters (front casters with brake)
up to 8 chairs stacked
only available for chair with 4 metal legs

Resistance test

The item has been tested following these regulations:

- ANSI BIFMA X5.1-2002,
- EN 1728:2000- UNI EN 15373:2007 Level 2 (chair)
- EN 1335:2000

Test copies available on request

Greenguard

Tate Soft has been certified with Greenguard Gold

Note

Stackable chair only upon request:
up to 6 pieces for sled base version
up to 8 pieces for 4 metal legs base version

	A	A ₀		B	B ₀		C		D		E		E ₁	G	G ₂	V	
•	Phill																
•	Trame																
•	Vancouver																
	Sorrento																
	Sorrento rigato																
•	Ecopelle																
	Trentino Stretto																
•	Vancouver																
	Ambro																
	Bielastico Color																
	Bielastico Optical																
•	Brecon																
	Corda																
•	Madrid																
•	Oceanic																
•	Vancouver																
	Baltimore Plus Eco																
•	Hallingdal 2																
•	Panno																
	Steelcut Trio																
•	Delft Velvet																
•	Dunmore Plaid																
•	Hardwick Plaid																
•	Hero 2																
•	Ivyside Herringbone																
•	Market Street Plaid																
	Veroniet																
•	Zero																
•	Chandigar																
•	Pelle																
•	Pelle Extra																
	Spotted leather																
	Artemidor																
	Pucci Cotton / Velvet																
	Hide																

Code description



47
18½"
81
31¾"

52
20½"
53
20¾"

		cat. A	cat. B	cat. C	cat. D	cat. E	cat. E1	cat. G	cat. G2	fabric lmt	leather sqmt
TS_1	Chair - 4 stainless steel legs	840	865	890	960	1.000	1.245	1.050	1.090	1	2
TS_10	Chair - 4 matt lacquered legs	810	830	855	920	975	1.210	1.010	1.060	1	2

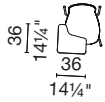

81
31¾"
77
30¼"
46,5
18¼"

56
22"
68
26¾"

		cat. A	cat. B	cat. C	cat. D	cat. E	cat. E1	cat. G	cat. G2	fabric lmt	leather sqmt
TS_2	Chair with writing board - 4 stainless steel legs	1.150	1.170	1.195	1.260	1.305	1.540	1.350	1.405	1	2



65,5
25¾"
102,5
40¼"

44,5
17½"
51
20"

		cat. A	cat. B	cat. C	cat. D	cat. E	cat. E1	cat. G	cat. G2	fabric lmt	leather sqmt
TS_11	Low stool with high back - 4 stainless steel legs	960	980	995	1.065	1.120	1.355	1.155	1.210	1	2
TS_110	Low stool with high back - 4 matt lacquered legs	885	905	920	990	1.050	1.280	1.080	1.130	1	2



80
31½"
117
46"

44,5
19¼"
52
20½"

		cat. A	cat. B	cat. C	cat. D	cat. E	cat. E1	cat. G	cat. G2	fabric lmt	leather sqmt
TS_12	High stool with high back - 4 stainless steel legs	970	985	1.000	1.070	1.120	1.360	1.170	1.215	1	2
TS_120	High stool with high back - 4 matt lacquered legs	890	910	925	995	1.050	1.285	1.090	1.135	1	2

Code description



65,5
25¾"
76
30"

44,5
17½"
49,5
19½"

		cat. A	cat. B	cat. C	cat. D	cat. E	cat. E1	cat. G	cat. G2	fabric lmt	leather sqmt
TS_11B	Low stool with low back - 4 stainless steel legs	915	920	940	995	1.045	1.220	1.050	1.075	0,8	1,5
TS_11BO	Low stool with low back - 4 matt lacquered legs	855	865	885	935	980	1.155	985	1.015	0,8	1,5



80
31½"
90
35½"

44,5
17½"
50
19¾"

		cat. A	cat. B	cat. C	cat. D	cat. E	cat. E1	cat. G	cat. G2	fabric lmt	leather sqmt
TS_12B	High stool with low back - 4 stainless steel legs	920	925	960	1.000	1.050	1.225	1.050	1.080	0,8	1,5
TS_12BO	High stool with low back - 4 matt lacquered legs	865	870	900	940	985	1.170	985	1.020	0,8	1,5



45,5
18"
81,5
32"

54,5
21½"
52
20½"

		cat. A	cat. B	cat. C	cat. D	cat. E	cat. E1	cat. G	cat. G2	fabric lmt	leather sqmt
TS_3	Chair - stainless steel sled base	940	960	985	1.055	1.100	1.335	1.135	1.195	1	2
TS_30	Chair - matt lacquered sled base	910	920	945	1.015	1.065	1.300	1.105	1.155	1	2



65,5
25¾"
101,5
40"

44,5
17½"
50
19¾"

		cat. A	cat. B	cat. C	cat. D	cat. E	cat. E1	cat. G	cat. G2	fabric lmt	leather sqmt
TS_31	Low stool with high back - stainless steel sled base	1.020	1.050	1.070	1.130	1.180	1.420	1.225	1.275	1	2
TS_310	Low stool with high back - matt lacquered sled base	945	975	995	1.060	1.105	1.350	1.150	1.200	1	2

Code description

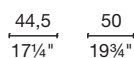
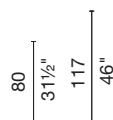
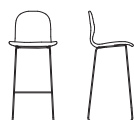

		cat. A	cat. B	cat. C	cat. D	cat. E	cat. E1	cat. G	cat. G2	fabric lmt	leather sqmt
TS_32	High stool with high back - stainless steel sled base	1.050	1.060	1.080	1.150	1.200	1.440	1.245	1.290	1	2
TS_320	High stool with high back - matt lacquered sled base	975	985	1.010	1.075	1.125	1.360	1.170	1.220	1	2

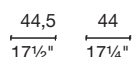
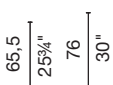

		cat. A	cat. B	cat. C	cat. D	cat. E	cat. E1	cat. G	cat. G2	fabric lmt	leather sqmt
TS_31B	Low stool with low back - stainless steel sled base	985	990	1.015	1.065	1.105	1.285	1.115	1.140	0,8	1,5
TS_31BO	Low stool with low back - matt lacquered sled base	920	925	960	1.000	1.050	1.225	1.055	1.080	0,8	1,5

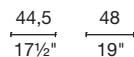
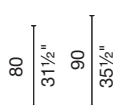

		cat. A	cat. B	cat. C	cat. D	cat. E	cat. E1	cat. G	cat. G2	fabric lmt	leather sqmt
TS_32B	High stool with low back - stainless steel sled base	995	1.010	1.045	1.080	1.120	1.300	1.125	1.170	0,8	1,5
TS_32BO	High stool with low back - matt lacquered sled base	935	945	980	1.020	1.060	1.245	1.065	1.105	0,8	1,5

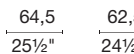
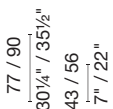

		cat. A	cat. B	cat. C	cat. D	cat. E	cat. E1	cat. G	cat. G2	fabric lmt	leather sqmt
TS_5H	Chair - 5 spokes chromed base with feet	995	1.015	1.050	1.115	1.155	1.405	1.200	1.250	1	2

Code description



66,5
26 1/4"



65,5
25 3/4"

81,5 / 94,5
32" / 37 1/4"
47,5 / 60,5
18 3/4" / 23 3/4"

	cat. A	cat. B	cat. C	cat. D	cat. E	cat. E1	cat. G	cat. G2	fabric lmt	leather sqmt
TS_5HR Chair - 5 spokes chromed base with casters	1.090	1.105	1.135	1.210	1.255	1.485	1.285	1.350	1	2



15,5
6"

73
28 3/4"

73
28 3/4"

		Price
CAR_1 Trolley		495

Stackable chair and stools in two heights, with high or low back, with oak or mahogany veneered beech plywood seat and different base options.



Shell

beech plywood

Shell finish

133 natural oak
155 white-stained oak
158 black-stained oak

164 mahogany

Base finish

435 satined stainless steel

satined matt lacquered in the colours:

01 white (RAL 9010)
71 mud (RAL 7006)
04 black (RAL 9005)
24 pumpkin (RAL 1024)
16 brick red (RAL 3016)
14 grass green (RAL 6000)
26 blue-green (RAL 6026)
17 prussian blue (RAL 5007)

Sled base

435 satined stainless steel

matt varnished

01 white
04 black
71 mud

5-spoke base

412 polished aluminium

Writing board

reclining, made of black high pressure laminate, available only with 4 metal legs base in stainless steel

Feet

black plastic

Casters

black and grey plastic with chromed crankcase

Trolley

black painted metal, on casters (front casters with brake)
up to 8 chairs stacked
only available for chair with 4 metal legs

Resistance test

The item has been tested following these regulations:

- ANSI BIFMA X5.1-2002,
- EN 1728:2000- UNI EN 15373:2007 Level 2 (chair)
- EN 1335:2000

Test copies available on request

Greenguard

Tate Wood has been certified with Greenguard Gold

Note

Stackable chair:
up to 6 pieces for sled base version
up to 8 pieces for 4 metal legs base version

Code description



46
18
80,5
31½"

51
20"
52,5
20¾"

		Price
TW_1	Chair - 4 stainless steel legs	660
TW_10	Chair - 4 matt lacquered legs	630

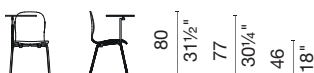
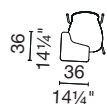

56
22"
68
26¾"

80
31½"
77
30¼"
46
18"

		Price
TW_2	Chair with writing board - 4 stainless steel legs	970



64,5
25½"
101,5
40"

43,5
17¼"
50,5
20"

		Price
TW_11	Low stool with high back - 4 stainless steel legs	760
TW_110	Low stool with high back - 4 matt lacquered legs	680



79
31"
116
45¾"

43,5
17¼"
51,5
20¾"

		Price
TW_12	High stool with high back - 4 stainless steel legs	770
TW_120	High stool with high back - 4 matt lacquered legs	695



64,5
25½"
75
29½"

43,5
17¼"
49
19¼"

		Price
TW_11B	Low stool with low back - 4 stainless steel legs	680
TW_11B0	Low stool with low back - 4 matt lacquered legs	610

Code description

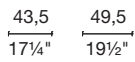
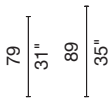

		Price
TW_12B	High stool with low back - 4 stainless steel legs	675
TW_12BO	High stool with low back - 4 matt lacquered legs	615

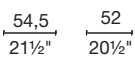
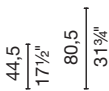

		Price
TW_3	Chair - stainless steel sled base	760
TW_30	Chair - matt lacquered sled base	730

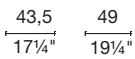

		Price
TW_31	Low stool with high back - stainless steel sled base	835
TW_310	Low stool with high back - matt lacquered sled base	760

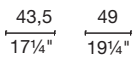

		Price
TW_32	High stool with high back - stainless steel sled base	845
TW_320	High stool with high back - matt lacquered sled base	775

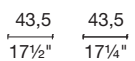
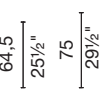

		Price
TW_31B	Low stool with low back - stainless steel sled base	740
TW_31BO	Low stool with low back - matt lacquered sled base	670

Code description

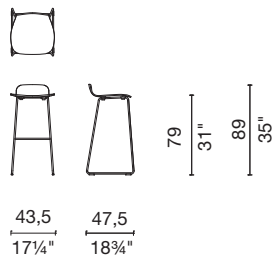

		Price
TW_32B	High stool with low back - stainless steel sled base	750
TW_32BO	High stool with low back - matt lacquered sled base	695

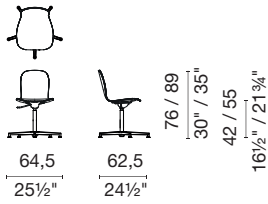

		Price
TW_5H	Chair - 5 spokes chromed base with feet	810

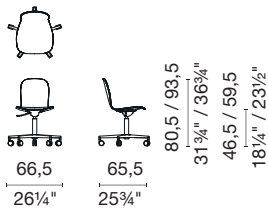

		Price
TW_5HR	Chair - 5 spokes chromed base with casters	890

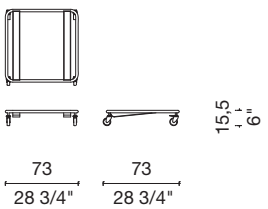

		Price
CAR_1	Trolley	495

index

beds

Bed	<i>Jasper Morrison</i>	212
Fronzoni '64	<i>AG Fronzoni</i>	215
Peg Bed	<i>Nendo</i>	216
Superoblong Bed	<i>Jasper Morrison</i>	218
Complements for beds		221

All items manufactured with polyurethane foam (moulded or in multidensity) correspond to Californian Technical Bulletin 117 - 2013, Section A part 1 and Section D part 2.

The following items can be manufactured with polyurethane foams British Standard BS 5852 – 1982 part 2: Bed.

Recommended fabrics and leathers for cover are indicated on proper schedule: LIST OF FABRICS at the end of the price list.

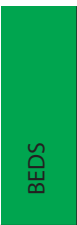

Series of padded beds on aluminium feet with removable cover in fabrics and leathers from the collection.



Structure

solid fir, poplar plywood, metal frame

Padding

multi-density polyurethane foam

Main bedstead

ash plywood slats

Base

polish natural aluminium

Feet

adjustable central feet in black varnished metal

Cover

removable in fabric and leather
upon request, the upholstery for each item can be ordered separately

Notes

Note 1

Prices do not include mattress

Note 2

On request beds NB_160/170/180/193/200 can be provided disassembled by applying a surcharge

Note 3

Adjustable central feet supplied for beds from 155 cm

	A	A _o		B	B _o	C				D		E				E ₁	G	G _s	V	
●	Phill																			
●	Trame																			
●	Vancouver																			
●	Sorrento																			
●	Sorrento rigato																			
●	Ecopelle																			
●	Trentino Stretto																			
●	Vancouver																			
●	Ambro																			
●	Blaetastico Color																			
●	Blaetastico Optical																			
●	Brecon																			
●	Conda																			
●	Madrid																			
●	Oceanic																			
●	Vancouver																			
●	Baltimore Plus Eco																			
●	Hallingdal 2																			
●	Panno																			
●	Steelcut Trio																			
●	Delft Velvet																			
●	Dunmore Plaid																			
●	Hardwick Plaid																			
●	Hero 2																			
●	Ivyside Herringbone																			
●	Market Street Plaid																			
●	Veronnet																			
●	Zero																			
●	Chandigar																			
●	Pelle																			
●	Pelle Extra																			
●	Spotted leather																			
●	Antemidor																			
●	Pucci Cotton / Velvet																			
●	Hide																			

Code description

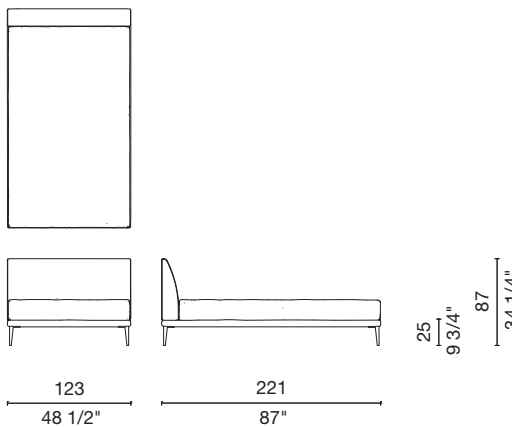

		cat. A	cat. B	cat. C	cat. D	cat. E	cat. E1	cat. G	cat. G2	fabric lmt	leather sqmt
NB_120	Single bed	3.720	3.790	3.885	4.230	4.365	5.110	4.725	4.875	3,85	6,16

Bed

design: Jasper Morrison 1991

Code description

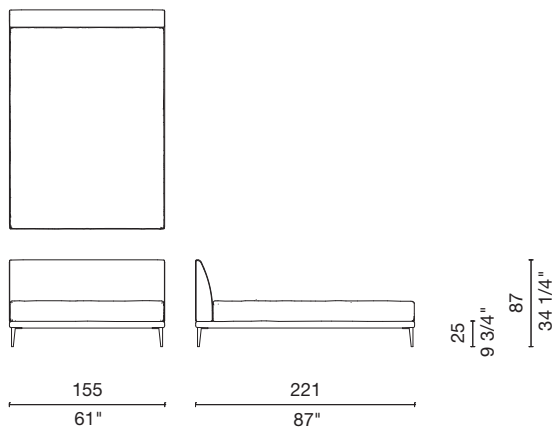

		cat. A	cat. B	cat. C	cat. D	cat. E	cat. E1	cat. G	cat. G2	fabric lmt	leather sqmt
NB_152	Bed	4.275	4.430	4.545	4.835	5.205	5.925	5.865	6.100	4,4	6,82

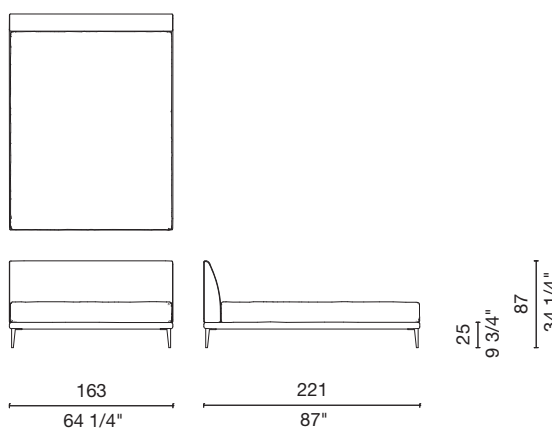

		cat. A	cat. B	cat. C	cat. D	cat. E	cat. E1	cat. G	cat. G2	fabric lmt	leather sqmt
NB_160	Bed	4.365	4.490	4.600	4.915	5.285	6.015	5.950	6.175	4,4	7,04

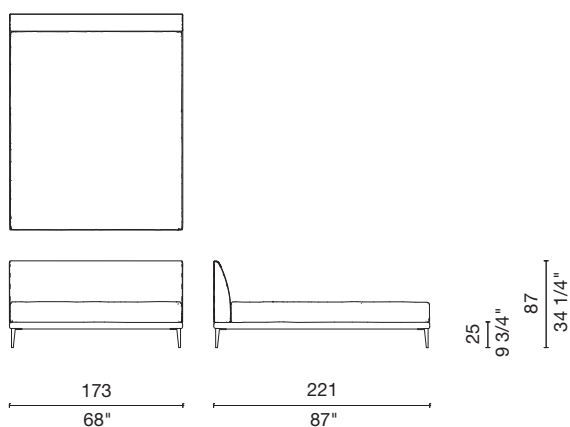

		cat. A	cat. B	cat. C	cat. D	cat. E	cat. E1	cat. G	cat. G2	fabric lmt	leather sqmt
NB_170	Bed	4.400	4.600	4.715	4.935	5.330	6.100	6.030	6.260	4,4	7,48

Bed

design: Jasper Morrison 1991

Code description

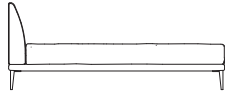
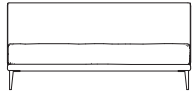
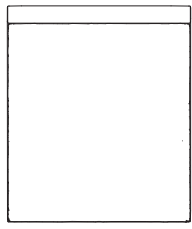

25
9 3/4"
87
34 1/4"

183
72"

221
87"

		cat. A	cat. B	cat. C	cat. D	cat. E	cat. E1	cat. G	cat. G2	fabric lmt	leather sqmt
NB_180	Bed	4.455	4.635	4.765	5.110	5.555	6.425	6.105	6.315	4,4	7,48

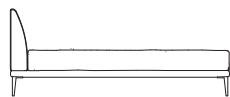
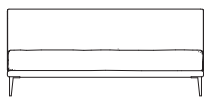
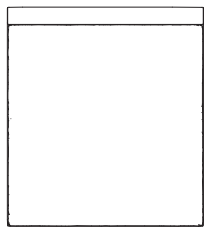

25
9 3/4"
87
34 1/4"

196
77 1/4"

221
87"

		cat. A	cat. B	cat. C	cat. D	cat. E	cat. E1	cat. G	cat. G2	fabric lmt	leather sqmt
NB_193	Bed	4.545	4.705	4.845	5.205	5.645	6.495	6.400	6.610	4,95	8,36

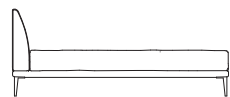
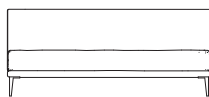
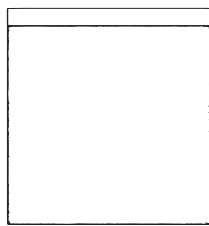

25
9 3/4"
87
34 1/4"

203
80"

221
87"

		cat. A	cat. B	cat. C	cat. D	cat. E	cat. E1	cat. G	cat. G2	fabric lmt	leather sqmt
NB_200	Bed	4.765	4.950	5.110	5.440	5.890	6.740	6.650	6.880	4,95	8,36

Series of beds characterised by a great geometric rigour, entirely manufactured in square metal tube, with slatted bedstead.



Structure

square metal tube

Structure finish

matt varnished

01 white

04 black

Bedstead

solid covered tulipier slats

Note

Prices do not include mattress

Code	description
------	-------------



		matt lacquer
FR_1	Bed	2.165



		matt lacquer
FR_6	Bed	3.460

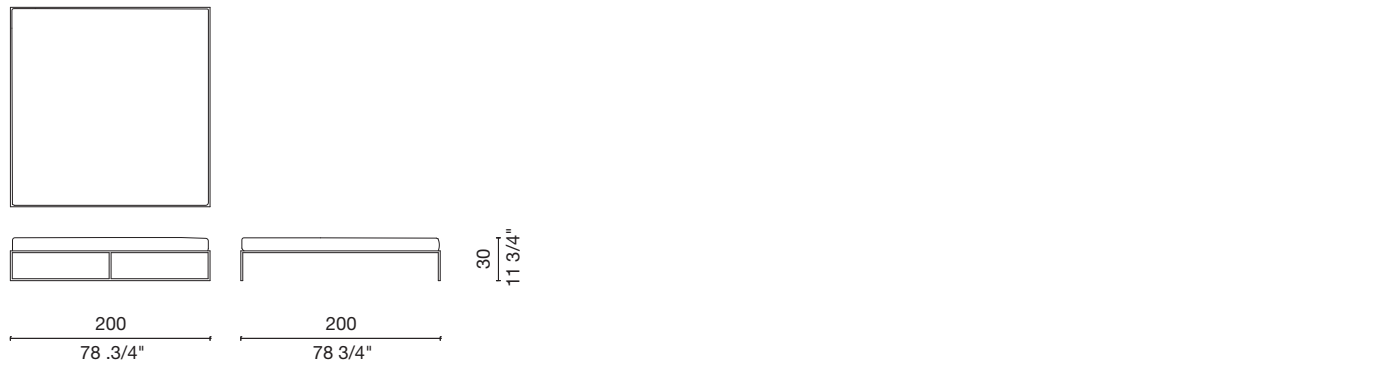

		matt lacquer
FR_2	Bed	3.685

Series of padded beds on solid ash wood feet with removable cover in fabrics and leathers from the collection.



Structure

solid fir, poplar plywood, metal frame

Headboard

resin composed

Padding

polyurethane foam

Structure bedstead

beech plywood slats and belts

Base

solid ash

Base finish

113 bleached ash
116 oak-stained ash
112 black-stained ash

Feet

adjustable central feet in black varnished metal

Cover

fixed in fabric and leather

Notes

Note 1

Beds are supplied as detached

Note 2

Thread in the same fabric and leather colour

Note 3

Prices do not include mattress
PEG152 - mattress cm 152x203
PEG 180 - mattress cm 180x200
PEG193 - mattress cm 193X203
PEG200 - 1 mattress cm 200x200 or 2 mattresses cm 100x200

Phill	A	A _o	B	B _o	C		D		E				E _i	G	G _s	V														
•	Trame		Sorrento rigato		Bielastico Color	Bielastico Optical	Brecon	Corda	Madrid	Oceanic	Vancouver	Baltimore Plus Eco	Hallingdal 2	Panno	Steelcut Trio	Delft Velvet	Dunmore Plaid	Hardwick Plaid	Hero 2	Ivyside Herringbone	Market Street Plaid	Veromet	Zero	Chandigar	Pelle	Pelle Extra	Spotted leather	Artemidor	Pucci Cotton / Velvet	Hide

Code description

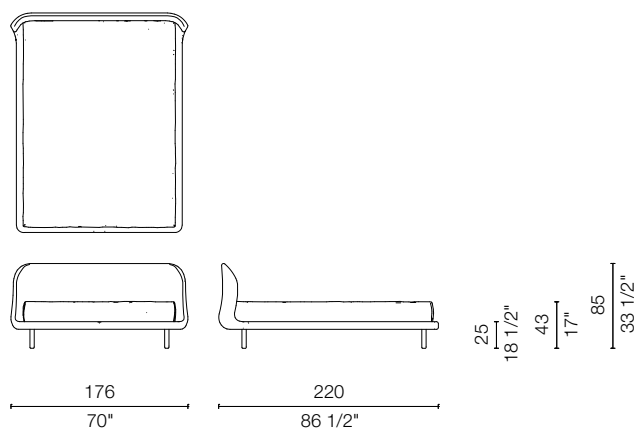

PEG152	Bed	cat. A	cat. B	cat. C	cat. D	cat. E	cat. E1	cat. G	cat. G2	fabric lmt	leather sqmt
		5.525	5.635	5.750	6.115	6.685	6.995	6.830	7.720	5,5	8,25

Peg Bed

design: Nendo 2014

Code description

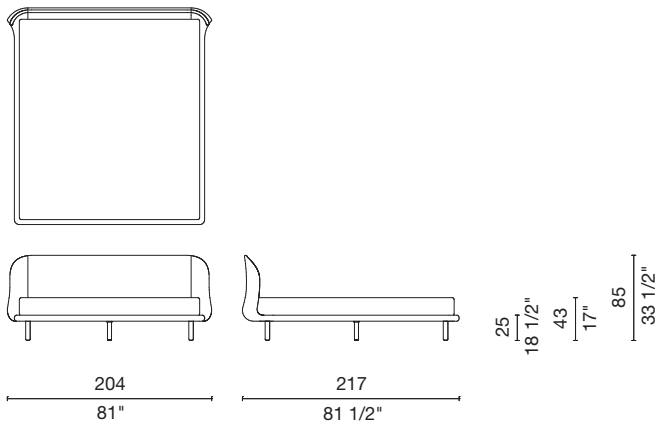

	cat. A	cat. B	cat. C	cat. D	cat. E	cat. E1	cat. G	cat. G2	fabric lmt	leather sqmt
PEG180 Bed	5.895	6.035	6.155	6.595	7.195	7.565	7.275	8.235	5,5	8,25

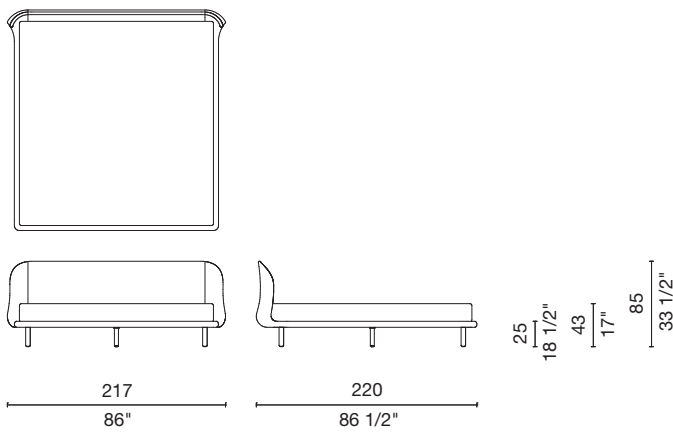

	cat. A	cat. B	cat. C	cat. D	cat. E	cat. E1	cat. G	cat. G2	fabric lmt	leather sqmt
PEG193 Bed	6.035	6.175	6.315	6.705	7.320	7.680	7.420	8.365	5,5	8,25

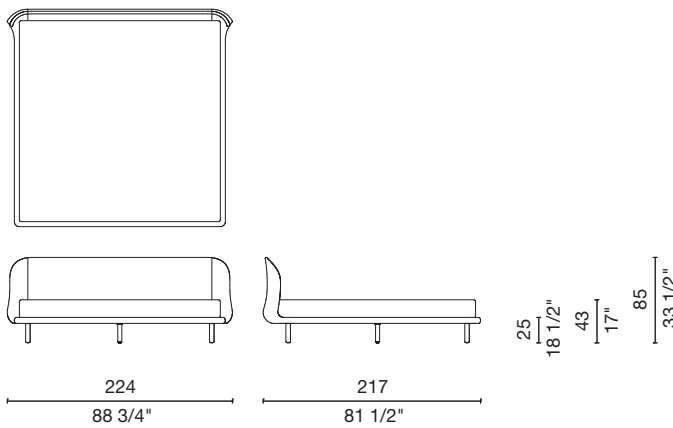

	cat. A	cat. B	cat. C	cat. D	cat. E	cat. E1	cat. G	cat. G2	fabric lmt	leather sqmt
PEG200 Bed	6.135	6.280	6.395	6.950	7.560	7.945	7.670	8.660	5,5	8,25

Series of padded beds with removable cover in fabrics and leathers from the collection, with different combinations of zippers.



Structure

in metal, poplar plywood and medium-density fibre panels

Padding

multi-density polyurethane foam, fibre and feather

Cover

removable in fabric and leather

upon request, the upholstery for each item can be ordered separately

Zippers

available in the following colours:

1 white - 2 beige - 3 blue - 4 fucsia - 5 brown - 6 black - 7 red - 8 turquoise - 9 green

Feet

adjustable central feet in black varnished metal

Fixed bedstead

beech plywood with slats

on request, an adjustable slat bedstead with manual movement is available with a price increase

Notes

Note 1

Stitching in the same colour of headboard zipper available in white, beige, black, brown, red, blue, green, turquoise and fucsia

Note 2

Bed is detachable

Note 3

Prices do not include mattress

Note 4

Please, specify on the order form the desired colours of the zipper. Stitching colour is the same of the zipper

Note 5

Adjustable central feet supplied for beds from 152 cm

	A	A ₀		B	B ₀	C			D			E				E ₁	G	G ₂	V		
•	Phill																				
•	Trame																				
•	Vancouver																				
	Sorrento																				
	Sorrento rigato																				
•	Ecopelle																				
•	Trentino Stretto																				
•	Vancouver																				
	Ambro																				
•	Bielastico Color																				
	Bielastico Optical																				
•	Brecon																				
•	Corda																				
•	Madrid																				
•	Oceanic																				
•	Vancouver																				
	Baltimore Plus Eco																				
•	Hallingdal 2																				
•	Panno																				
•	Steelcut Trio																				
•	Delft Velvet																				
•	Dunmore Plaid																				
•	Hardwick Plaid																				
•	Hero 2																				
•	Ivyside Herringbone																				
•	Market Street Plaid																				
•	Veronnet																				
•	Zero																				
•	Chandigar																				
•	Pelle																				
•	Pelle Extra																				
	Spotted leather																				
	Artemidor																				
	Pucci Cotton / Velvet																				
	Hide																				

Code description

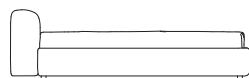
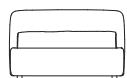
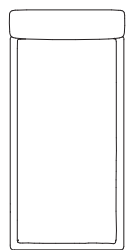

30
11 3/4"
68
26 3/4"

112 238
44" 93 3/4"

		cat. A	cat. B	cat. C	cat. D	cat. E	cat. E1	cat. G	cat. G2	fabric lmt	leather sqmt
SB_100	Single bed	3.585	3.685	3.830	4.290	4.475	5.515	4.785	5.160	4,5	10,23

Superoblong Bed

design: Jasper Morrison 2012

Code description

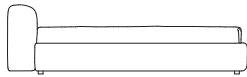
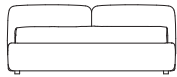
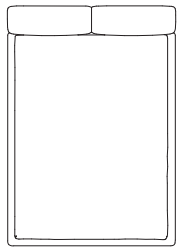

30
11 3/4"
68
26 3/4"

166
65 1/4"

238
93 3/4"

	cat. A	cat. B	cat. C	cat. D	cat. E	cat. E1	cat. G	cat. G2	fabric lmt	leather sqmt
SB_152 Bed	5.310	5.790	5.990	6.675	6.925	8.435	7.380	7.735	6,38	10,23

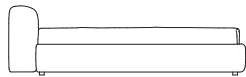
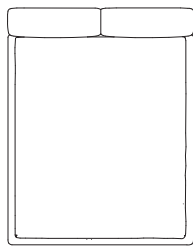

30
11 3/4"
68
26 3/4"

184
72 1/2"

235
92 1/2"

	cat. A	cat. B	cat. C	cat. D	cat. E	cat. E1	cat. G	cat. G2	fabric lmt	leather sqmt
SB_170 Bed	5.345	5.990	6.165	6.825	7.085	8.555	7.540	7.855	6,38	10,23

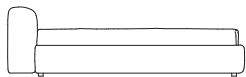
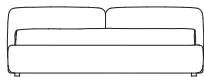
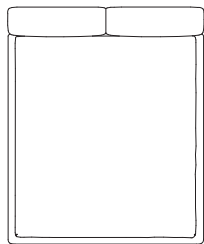

30
11 3/4"
68
26 3/4"

194
76 1/2"

235
92 1/2"

	cat. A	cat. B	cat. C	cat. D	cat. E	cat. E1	cat. G	cat. G2	fabric lmt	leather sqmt
SB_180 Bed	6.100	6.240	6.430	7.085	7.340	8.815	7.820	8.140	6,38	10,23

Superoblong Bed

design: Jasper Morrison 2012

Code description

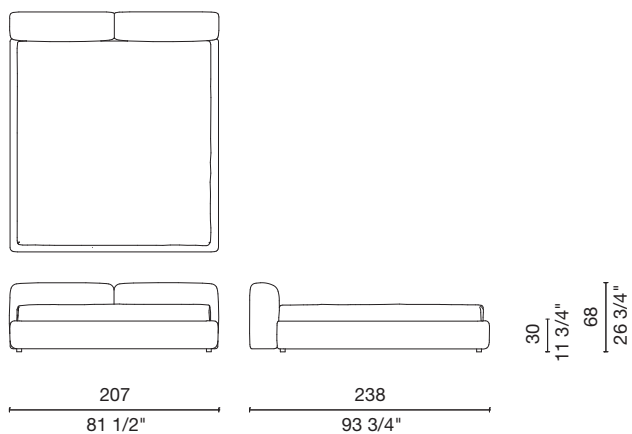

		cat. A	cat. B	cat. C	cat. D	cat. E	cat. E1	cat. G	cat. G2	fabric lmt	leather sqmt
SB_193	Bed	6.530	6.705	6.910	7.595	7.840	9.360	8.305	8.650	6,38	10,23

Complements for beds

Mattress

spring MT - Standard or Fireproof I
latex MTL - Standard or Fireproof I

Coverlet

in fabrics of collection
customer's fabric = cat. A

Pillow

in feather

Cover for pillow

in fabrics of collection

customer's fabric = cat. A

Notes

Note 1

with adjustable bedsteads= only latex mattresses

Note 2

the fireproof mattresses (I) correspond to BS
7177:2008 low hazard and 16 CFR 1632

Matching beds and mattresses

MTL76 (2 mattresses)	NB_152 - SB_152
MTL80 (2 mattresses)	NB_160
MTL85 (2 mattresses)	NB_170 - SB_170
MT_90 – MTL90 (2 mat.)	NB_180 - SB_180
MTL96 (2 mattresses)	NB_193 - SB_193
MT_100 – MTL100)	FR_1 - SB_100
MT_100 – MTL100 (2 mat.)	NB_200 - FR_2
MT_120 - MTL120	NB_120
MT_152 - MTL152	NB_152 - SB_152
MT_160 - MTL160	NB_160
MT_170 - MTL170	NB_170 - FR_6 - SB170
MT_180	NB_180 - SB_180
MT_193	NB_193 - SB_193
MT_200	NB_200 - FR_2

Complements for beds

		Standard	Fireproof
MTL76	Latex mattress cm. 76x203x18	1.390	
MTL76I	Latex mattress cm. 76x203x18		1.835
MTL80	Latex mattress cm. 80x200x18	1.410	
MTL80I	Latex mattress cm. 80x200x18		1.950
MTL85	Latex mattress cm. 85x200x18	1.465	
MTL85I	Latex mattress cm. 85x200x18		2.040
MTL90	Latex mattress cm. 90x200x18	1.605	
MTL90I	Latex mattress cm. 90x200x18		2.200
MT_90	Spring mattress cm. 90x200x18	680	
MT_90I	Spring mattress cm. 90x200x18		1.160
MTL96	Latex mattress cm. 96x203x18	1.715	
MTL96I	Latex mattress cm. 96x203x18		2.720
MT_100	Spring mattress cm. 100x200x18	735	
MT_100I	Spring mattress cm. 100x200x18		1.270
MTL100	Latex mattress cm.100x200x18	1.730	
MTL100I	Latex mattress cm.100x200x18		2.420
MT_120	Spring mattress cm.120x200x18	1.095	
MT_120I	Spring mattress cm.120x200x18		1.860
MTL120	Latex mattress cm.120x200x18	2.370	
MTL120I	Latex mattress cm.120x200x18		2.880
MT_152	Spring mattress cm.152x203x18	1.170	
MT_152I	Spring mattress cm.152x203x18		1.815
MTL152	Latex mattress cm.152x203x18	2.545	
MTL152I	Latex mattress cm.152x203x18		3.425

		Standard	Fireproof
MT_160	Spring mattress cm.160x200x18	1.120	
MT_160I	Spring mattress cm.160x200x18		1.910
MTL160	Latex mattress cm.160x200x18	2.650	
MTL160I	Latex mattress cm.160x200x18		3.710
MT_170	Spring mattress	1.130	
MT_170I	Spring mattress cm.170x200x18		2.055
MTL170	Latex mattress cm.170x200x18	2.685	
MTL170I	Latex mattress cm.170x200x18		3.730
MT_180	Spring mattress cm.180x200x18	1.185	
MT_180I	Spring mattress cm.180x200x18		2.055
MT_193	Spring mattress cm.193x203x18	1.525	
MT_193I	Spring mattress cm.193x203x18		2.570
MT_200	Spring mattress cm. 200x200x18	1.485	
MT_200I	Spring mattress cm. 200x200x18		2.545
CM_GS	Feather pillow	215	
CM_GM	2 feather pillows	360	

		cat. A	cat. B	cat. C	cat. D	cat. E	cat. E1	fabric lmt
CM_CS	Coverlet for mattress from cm. 100 to cm. 120	1.015	1.185	1.330	1.675	2.125	2.950	9,13
CM_CF	Coverlet for mattress from cm. 152 to cm. 160	1.080	1.240	1.390	1.715	2.175	2.990	9,13
CM_CM	Coverlet for mattress from cm. 170 to cm. 200	1.095	1.270	1.400	1.730	2.190	3.025	9,13
CM_CGS	Cover for pillow	225	255	300	360	455	620	1,21
CM_CGM	2 pillow covers	390	455	500	665	840	1.160	2,42

index

complementary

Hangman	<i>Marc Newson</i>	224
Koeda	<i>Nendo</i>	225
Mirror	<i>Jasper Morrison</i>	226
Poh (Patchwork oval hemisphere)	<i>Raphael Navot</i>	227
Steel Pipe Drink Trolley (1968)	<i>Shiro Kuramata</i>	228
Tuta	<i>Nendo</i>	229

Stainless steel coat hanger available in two different sizes.

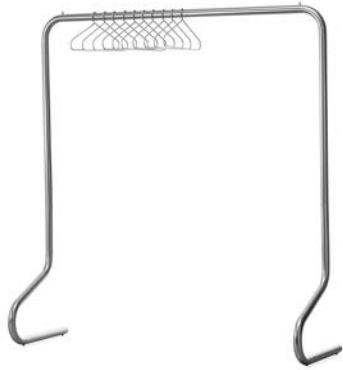

Structure

435 satined stainless steel

Feet

black plastic

Code	description
------	-------------

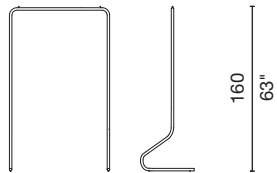

100
39 1/4"

53
21"

HG_1	Clothes-hanger	Price
		1.655

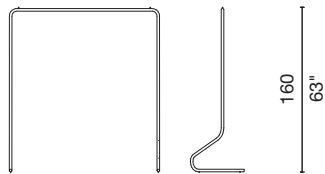

150
59"

53
21"

HG_2	Clothes-hanger	Price
		1.740

Free-standing coat hanger made of square and round metal bars. The weight-bearing structure, characterised by a great geometric rigour, is interrupted by a single inner branch, without compromising the stability of the frame.



Structure

square and round metal bars

Finishes

matt varnished

01 white

04 black

71 mud

Feet

transparent plastic

Code description

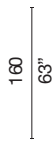

160

63"

35

35

13 3/4"

13 3/4"

		Price
KOE1	Clothes-hanger	1.650

Double-face floor mirror with adjustable inclination.



Structure

metal

Finish

satined nickel

Mirror

stratified, mm. 4 + mm. 4

Feet

black felt pads

Code description

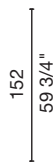
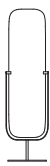

152

59 3/4"

44

39

17 1/4" 15 1/4"

		Price
MI_1	Mirror	1.795

Poh (Patchwork oval hemisphere)

design: Raphael Navot 2012

Bench manufactured as a patchwork of pieces of raw wood, assembled by hand and carved by a CNC machine. Each item is unique, sold in numbered edition.



Inner structure

in poplar wood and solid poplar, covered in solid American natural walnut

Finish

American natural walnut

Notes

Note 1

Due to their particular way of production, each piece is different from another

Note 2

Possible wood colour variations to be considered as features of natural wood working, not as defective features

Note 3

The item is sold in numbered edition

Code	description	Price
POH	Bench	26.065

Trolley on casters with tubular iron structure and laminate shelves.



Structure

matt black epoxy powder painted iron tube

Shelves

white thick laminate

Caster

matt black carter, grey plastic caster available for semisoft surfaces

Code description

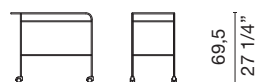

82 41,5
32 1/4" 16 1/4"

69,5
27 1/4"

		Price
PC_21	Tray	1.755

Floor coat hanger made of matt varnished laser-cut metal structure.



Structure

laser-cut metal plate

Finish

matt varnished
01 white
04 black
71 mud

Feet

black plastic or transparent

Code description

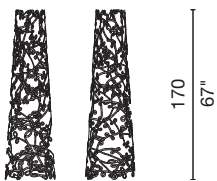

28,5	28,5
11 1/4"	11 1/4"
50	50
19 3/4"	19 3/4"

		Price
TU_1	Clothes-hanger	2.280

index

Outdoor

tables and service tables	233
sofas and armchairs	241
chairs, stools and small armchairs	249

OUTDOOR

tables and service tables

Bong Lido	<i>Giulio Cappellini</i>	234
Branch Table Lido	<i>Jakob Wagner</i>	235
Break Lido	<i>Giulio Cappellini</i>	236
Gong Lido	<i>Giulio Cappellini</i>	238
Mini Bottle Lido	<i>E. Barber & J. Osgerby</i>	239
Vendicari Lido	<i>Jangir Maddadi</i>	240

Low spherical coffee table with round top in fibre glass and resin, available in a selection of colours.



Structure

fibreglass and resin

Finitura



outdoor liquid coating
 OC1 pure white - RAL 9010
 OC2 violet blue - RAL 5000
 OC3 oxide red - RAL 3009

Feet

grey pads

Note

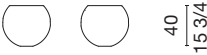
The furniture of the outdoor collection is designed for covered outdoor spaces, such as verandas, balconies and terraces: when not used, it is recommended to put the appropriate protective cover on the products after their complete drying to prevent the accumulation of moisture and formation of mould

Code	description	Price
		
		
		
		
BG_1E	Service table	1.330
BG_1EH	Protective cover for service table	280

Tables available in two different dimensions with aluminium base and top made of solid iroko slats.



Top

raw solid iroko slats

Base

base made of intertwined modules in die-cast aluminium

Base finish

embossed powder coating
OC1 pure white - RAL 9010

Feet

gray pads

Note

The furniture of the outdoor collection is designed for covered outdoor spaces, such as verandas, balconies and terraces: when not used, it is recommended to put the appropriate protective cover on the products after their complete drying to prevent the accumulation of moisture and formation of mould

Code description

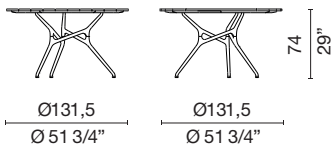
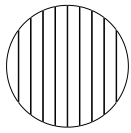

Code	description	Price
BR_1E	Table	3.930
BR_1EH	Protective cover for table	485

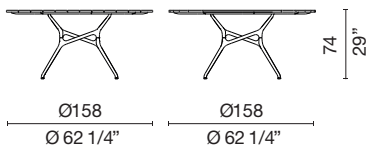
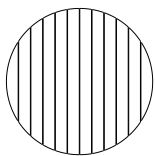

Code	description	Price
BR_3E	Table	4.820
BR_3EH	Protective cover for table	550

Series of tables in different dimensions with stainless steel base and square or round top, made of vitrified lava stone or marble.



Top

vitrified lava stone

marble

Top finish

vitrified lava stone:

602 blue

603 bordeaux

521 white Carrara marble

Undertop

cast iron, matt black painted

Base

AISI 304 stainless steel

Base finish

embossed powder coating

OC1 pure white - RAL 9010

Feet

adjustable, black plastic

Note

The furniture of the outdoor collection is designed for covered outdoor spaces, such as verandas, balconies and terraces: when not used, it is recommended to put the appropriate protective cover on the products after their complete drying to prevent the accumulation of moisture and formation of mould

Code description

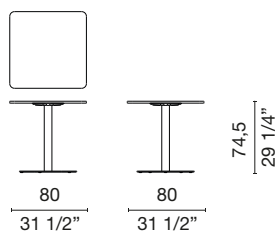

		lava stone	white Carrara	Price
BEO1A	Table with square top	3.380	2.410	
BEO1AH	Protective cover for table			305

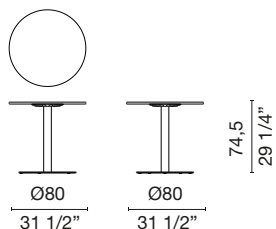

		lava stone	white Carrara	Price
BEO2A	Table with round top	3.380	2.410	
BEO2AH	Protective cover for table			305

Break Lido

design: Giulio Cappellini 2023

Code description

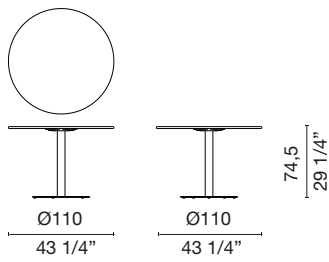

		lava stone	white Carrara	Price
BEO3A	Table with round top	5.135	3.565	
BEO3AH	Protective cover for table			400

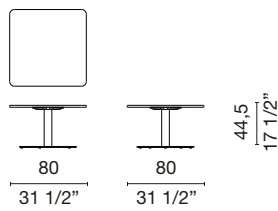

		lava stone	white Carrara	Price
BEO1B	Service table with square top	3.265	2.350	
BEO1BH	Protective cover for service table			280

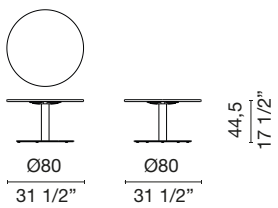

		lava stone	white Carrara	Price
BEO2B	Service table with round top	3.355	2.390	
BEO2BH	Protective cover for service table			280

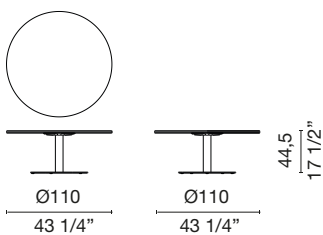

		lava stone	white Carrara	Price
BEO3B	Service table with round top	5.075	3.565	
BEO3BH	Protective cover for service table			335

Service table characterised by a very minimal design, available in two dimensions, made of two round laser-cut metal plates linked through a thin rod.



Base

laser-cut AISI 304 stainless steel sheet

Stem

AISI 304 stainless steel rod

Top

laser-cut AISI 304 stainless steel sheet

Finish

embossed powder coating
 OC1 pure white - RAL 9010
 OC2 violet blue - RAL 5000
 OC3 oxide red - RAL 3009

Feet

grey felt pads

Notes

Note 1

Free colour matching for base, stem and top are not available

Note 2

The furniture of the outdoor collection is designed for covered outdoor spaces, such as verandas, balconies and terraces: when not used, it is recommended to put the appropriate protective cover on the products after their complete drying to prevent the accumulation of moisture and formation of mould

Code	description
------	-------------

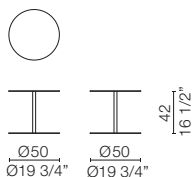

		Price
GG_1E	High service table	820
GG_1EH	Protective cover for service table	215

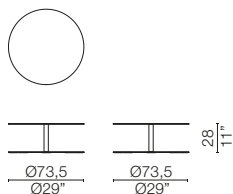

		Price
GG_2E	Low service table	1.875
GG_2EH	Protective cover for service table	245

Low service table made of handcrafted refractory ceramic.



Structure

hand-worked refractory ceramic

Structure finish

matt satined white CBI

Base

black felt

Notes

Note 1

Handmade side table made by master ceramic craftsmen. Since they are high quality artisanal products, any irregularities or slight differences in colours are to be considered an added value

Note 2

The furniture of the outdoor collection is designed for covered outdoor spaces, such as verandas, balconies and terraces: when not used, it is recommended to put the appropriate protective cover on the products after their complete drying to prevent the accumulation of moisture and formation of mould

Note 3

Do not expose the product to direct sunlight

Code description



42
16 1/2"

Ø45 Ø45
Ø17 3/4" Ø17 3/4"

Code	description	Price
BTL4CE	Service table	1.605
BTL4CEH	Protective cover for service table	215

Series of tables in different dimensions with stainless steel frame and top made of aluminium slats.



Structure

detachable, made of AISI 304 stainless steel tube

Top

bent laser-cut aluminium sheet

Finish

embossed powder coating
 OC1 pure white - RAL 9010
 OC2 violet blue - RAL 5000
 OC3 oxide red - RAL 3009

Feet

grey felt

Notes

Note 1

Regardless of the structure colour, the screws always come in AISI 304 stainless steel finish

Note 2

The furniture of the outdoor collection is designed for covered outdoor spaces, such as verandas, balconies and terraces: when not used, it is recommended to put the appropriate protective cover on the products after their complete drying to prevent the accumulation of moisture and formation of mould

Code description

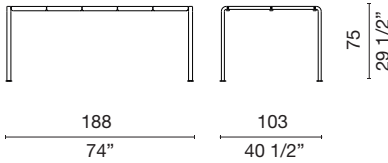
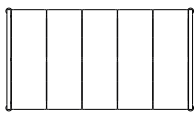

		Price
VN_3E	Table	3.615
VN_3EH	Protective cover for table	485

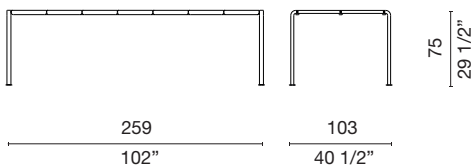
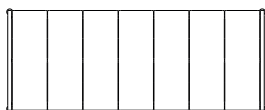

		Price
VN_4E	Table	4.215
VN_4EH	Protective cover for table	605

index

sofas and armchairs

InOut Lido	<i>Jean-Marie Massaud</i>	242
Litos Lido	<i>Sebastian Herkner</i>	243
Newood Relax Lido	<i>BrogliatoTraverso</i>	244
Orgone Lido	<i>Marc Newson</i>	245
Thinking Man's Chair Lido	<i>Jasper Morrison</i>	246
Vendicari Lido	<i>Jangir Maddadi</i>	247
Cushions		248

Sofa and bench with metal base and structure made of polish lacquered fiberglass in a selection of colours.



Structure

fiberglass and metal frame

Finish

polish varnished
 802 orange
 803 red
 805 blue
 806 white
 807 black

Base

AISI 304 stainless steel

Base finish

435 satined stainless steel

Feet

black felt pads

Notes

Note 1

The furniture of the outdoor collection is designed for covered outdoor spaces, such as verandas, balconies and terraces: when not used, it is recommended to put the appropriate protective cover on the products after their complete drying to prevent the accumulation of moisture and formation of mould

Note 2

Do not expose the product to direct sunlight

Code description

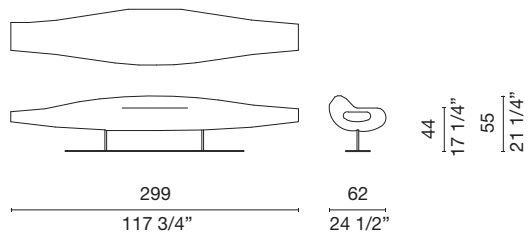

		Price
IO_1S	Fiberglass sofa	9.030
IO_1SH	Protective cover for fiberglass sofa	615

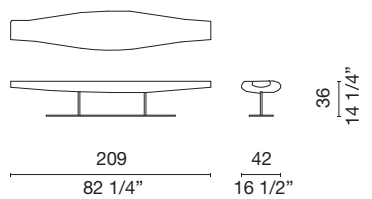

		Price
IO_2S	Fiberglass bench	6.005
IO_2SH	Protective cover for fiberglass bench	490

Free-standing seating element that can be also used in linear compositions, with removable upholstery in a selection of outdoor fabrics.



Structure

marine plywood panels

Padding

multi-density polyurethane foam and polyester fibre with waterproof lining

Upholstery

removable in fabric

Feet

black plastic

Notes

Note 1

The stitching colour is always in tone on tone thread

Note 2

Combination of different colours of the same fabric is not available

Note 3

The furniture of the outdoor collection is designed for covered outdoor spaces, such as verandas, balconies and terraces: when not used, it is recommended to put the appropriate protective cover on the products after their complete drying to prevent the accumulation of moisture and formation of mould

	A	A ₀		B	B ₀	C				D		E				E ₁	G	G ₂	V	
Phill																				
Trame																				
Vancouver																				
● Sorrento																				
● Sorrento rigato																				
Ecopelle																				
Trentino Stretto																				
Vancouver																				
● Ambro																				
Bielastico Color																				
Bielastico Optical																				
Brecon																				
Corda																				
Madrid																				
Oceanic																				
Vancouver																				
Baltimora Plus Eco																				
Hallingdal 2																				
Panno																				
Steelcut Trio																				
Delft Velvet																				
Dunmore Plaid																				
Hardwick Plaid																				
Hero 2																				
Ivyside Herringbone																				
Market Street Plaid																				
Veronnet																				
Zero																				
Chandigar																				
Pelle																				
Pelle Extra																				
Spotted leather																				
Artemidor																				
Pucci Cotton / Velvet																				
Hide																				

Code description



99
39"



106
41 3/4"



40
15 1/2"

67
23 1/4"

		cat. A ₀	Sorrento rigato	cat. B ₀	Price
LT_13E	Seat element	3.135	3.265	3.265	
LT_13EH	Protective cover for seat element				365

Small armchair and loveseat with frame made of solid iroko. Removable seat cushion covered with internal waterproof lining and removable upholstery in a selection of outdoor fabrics.



Structure

raw solid iroko

Seat

iroko veneered okume plywood

Removable cushion

removable, made of multi-density polyurethane foam and polyester wadding with waterproof lining

Cushion upholstery

removable in fabric

Feet

black plastic

Notes

Nota 1

The removable cushion is fixed to the seat by means of velcro-type ribbons

Nota 2

The furniture of the outdoor collection is designed for covered outdoor spaces, such as verandas, balconies and terraces: when not used, it is recommended to put the appropriate protective cover on the products after their complete drying to prevent the accumulation of moisture and formation of mould

Phil	A	A _o	B	B _o	C	D	E	E _i	G	G _s	V
	Trame										
	Vancouver										
	Sorrento	●									
	Sorrento rigato	●									
	Ecopelle										
	Trentino Stretto										
	Vancouver										
	Ambro	●									
	Bielastico Color										
	Bielastico Optical										
	Brescon										
	Corda										
	Madrid										
	Oceanic										
	Vancouver										
	Balimora Plus Eco										
	Hallingdal 2										
	Panno										
	Steelcut Trio										
	Delft Velvet										
	Dunmore Plaid										
	Hardwick Plaid										
	Hero 2										
	Ivyside Herringbone										
	Marker Street Plaid										
	Veronnet										
	Zero										
	Chandigar										
	Pelle										
	Pelle Extra										
	Spotted leather										
	Artemidor										
	Pucci Cotton / Velvet										
	Hide										

Code description

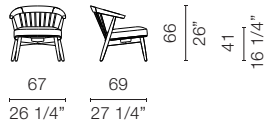

		cat. A _o	Sorrento rigato	cat. B _o	Price
NW_3RE	Armchair	2.410	2.480	2.540	
NW_3REH	Protective cover for armchair				365

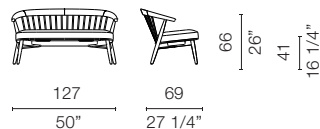
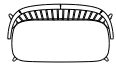

		cat. A _o	Sorrento rigato	cat. B _o	Price
NW_4RE	Loveseat	3.930	4.015	4.110	
NW_4REH	Protective cover for loveseat				575

Chaise longue manufactured in polish lacquered fiberglass.



Structure

fiberglass

Finish

polish varnished
806 white

Feet

black plastic

Notes

Note 1

The furniture of the outdoor collection is designed for covered outdoor spaces, such as verandas, balconies and terraces: when not used, it is recommended to put the appropriate protective cover on the products after their complete drying to prevent the accumulation of moisture and formation of mould

Note 2

Do not expose the product to direct sunlight

Code description



32
12 1/2"
50
19 3/4"

38
15"
74
29 1/4"

181
71 1/4"

		Price
MN_4	Chaise longue	5.705
MN_4H	Protective cover for chaise longue	365

Relax armchair, consisting only of structural metal elements, whose armrests are provided with small cup holder trays.



Structure

AISI 304 stainless steel tube and flat bars

Finish

embossed powder coating
 OC1 pure white - RAL 9010
 OC2 violet blue - RAL 5000
 OC3 oxide red - RAL 3009

Feet

black plastic

Note

The furniture of the outdoor collection is designed for covered outdoor spaces, such as verandas, balconies and terraces: when not used, it is recommended to put the appropriate protective cover on the products after their complete drying to prevent the accumulation of moisture and formation of mould

Code description



35
 13 3/4"
 70
 27 1/2"

63,5
 25"

96
 37 3/4"

Code	Description	Price
TM_1E	Armchair	3.655
TM_1EH	Protective cover for armchair	335

Aluminium armchair with armrests.



Structure

flat aluminium bars and support rods

Finish

embossed powder coating
 OC1 pure white - RAL 9010
 OC2 violet blue - RAL 5000
 OC3 oxide red - RAL 3009

Removable cushion

polyester wadding with waterproof lining

Cushion upholstery

removable in fabric

Feet

grey felt

Notes

Note 1

The base beams are fastened with AISI 304 stainless steel screws, varnished in the same colour as the structure

Note 2

The removable cushion is fixed to the structure by means of automatic buttons, which allow it to slide between the backrest and the seat. When used on the backrest, the cushion is fastened to the upper side by means of a specific pouch where the extremities of the slats are inserted

Note 3

The furniture of the outdoor collection is designed for covered outdoor spaces, such as verandas, balconies and terraces: when not used, it is recommended to put the appropriate protective cover on the products after their complete drying to prevent the accumulation of moisture and formation of mould

Phil	A	A ₀	B	B ₀	C	D	E	E ₁	G	G ₂	V																							
	Trame	Vancouver	Sorrento	Sorrento rigato	Ecoppelle	Trentino Stretto	Vancouver	Ambro	Bielastico Color	Bielastico Optical	Brecon	Corda	Madrid	Oceanic	Vancouver	Baltimore Plus Eco	Hallingdal 2	Panno	Steelcut Trio	Delft Velvet	Dunmore Plaid	Hardwick Plaid	Hero 2	Ivyside Herringbone	Market Street Plaid	Veronnet	Zero	Chandigar	Pelle	Pelle Extra	Spotted leather	Artemidor	Pucci Cotton / Velvet	Hide

Code description

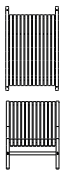

28 11" 82 32 1/4"

63,5 25" 101 39 3/4"

Code	Description	Price
VN_1E	Armchair	1.925
VN_1EH	Protective cover for armchair	335

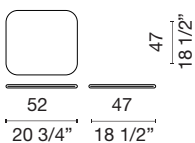

47 18 1/2"

52 20 3/4" 47 18 1/2"

Code	Description	cat. A ₀	Sorrento rigato	cat. B ₀
VNX1E	Removable seat cushion	200	210	215

Cushions

Series of cushions to complete armchairs and sofas, with removable cover in fabric.

Padding

polyester fiber with waterproof lining

Cover

removable in fabric

Note

The furniture of the outdoor collection is designed for covered outdoor spaces, such as verandas, balconies and terraces: when not used, it is recommended to put the appropriate protective cover on the products after their complete drying to prevent the accumulation of moisture and formation of mould

Phill	A	A _o	B	B _o	C	D	E	E ₁	G	G ₂	V
	Trame										
	Vancouver										
	Sorrento	•									
	Sorrento rigato	•									
	Escopelle										
	Trentino Stretto										
	Vancouver										
	Ambro	•									
	Bielastico Color										
	Bielastico Optical										
	Brecon										
	Corca										
	Madrid										
	Oceahic										
	Vancouver										
	Baltimora Plus Eco										
	Hallingdal 2										
	Panno										
	Steelcut Trio										
	Delft Velvet										
	Dunmore Plaid										
	Hardwick Plaid										
	Hero 2										
	Ivyside Herringbone										
	Market Street Plaid										
	Veronnet										
	Zero										
	Chandigar										
	Pelle										
	Pelle Extra										
	Spotted leather										
	Artemidor										
	Pucci Cotton / Velvet										
	Hide										

Code description



50
19 3/4"

50
19 3/4"

Code	description	cat. A _o	Sorrento rigato	cat. B _o	fabric lmt	leather sqmt
CM_50E	Cushion	250	270	290	1,56	1,2

chairs, stools and small armchairs

Gilda Lido	<i>Scholten & Baijings</i>	250
Juli Re-Plastic Lido	<i>Werner Aisslinger</i>	251
Newood Light Lido	<i>BrogliatoTraverso</i>	252
Vendicari Lido	<i>Jangir Maddadi</i>	253

Armchair made of stainless steel and aluminium with hand-woven back and armrests. The seat can be equipped with a removable cushion.



Structure

AISI 304 stainless steel tube

Seat

aluminium tube and sheet

Finish

embossed powder coating
OC1 pure white - RAL 9010

Removable cushion

polyurethane foam and polyester wadding with waterproof lining

Cushion upholstery

removable in fabric Ambro B02

Twine

rope made of polypropylene and polyethylene yarn

Feet

hemispherical, black plastic

Notes

Nota 1

The seat is equipped with a hole for water draining

Nota 2

The removable cushion is fixed to the seat by means of velcro-type bands

Nota 3

The furniture of the outdoor collection is designed for covered outdoor spaces, such as verandas, balconies and terraces: when not used, it is recommended to put the appropriate protective cover on the products after their complete drying to prevent the accumulation of moisture and formation of mould

Code description

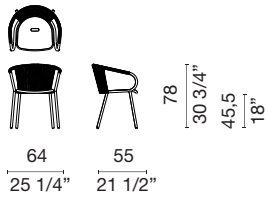

		Price
GB_1E	Small armchair	965
GB_1EH	Protective cover for small armchair	305

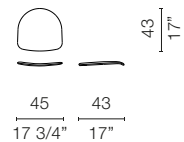

		cat. B ₀
GBX1E	Removable seat cushion	165

Small armchair with armrests, with stainless steel base and shell made of recycled and recyclable polypropylene with glass fiber.



Structure

recycled and recyclable polypropylene shell with glass fiber, obtained from recycled domestic waste

Structure finish

JRE Grey

4 metal legs base

AISI 316 stainless steel tube Ø20m

Base finish

435 satined stainless steel

embossed powder coating
OC1 pure white - RAL 9010

Feet

black plastic

Notes

Note 1

Recycled and recyclable polypropylene shell with glass fiber, obtained from recycled domestic waste, such as wasted plastic packaging. The use of polypropilene ensures to save up to 54% of gas emission

Note 2

The glass fiber shell guarantees a high impact resistance, better mechanical properties and greater tensile strength

Note 3

The shell is made of Procyclen® PP 20 M40 C07 GF20, with UV protection additives

Note 4

Being a post-consumer granulate, the color and the dots of the shell can be different between the various supplies. This characteristic is not to be considered a defect but a characteristic of the origin of the recycled material

Note 5

Upon request, it is possible to get a predrilled seat for water draining

Note 6

The furniture of the outdoor collection is designed for covered outdoor spaces, such as verandas, balconies and terraces: when not used, it is recommended to put the appropriate protective cover on the products after their complete drying to prevent the accumulation of moisture and formation of mould

Code description



80,5
31 3/4"
45,5
18"

66,5
26 1/4"

57
22 1/4"

		Price
JUP6E	Armchair with 4 metal legs	435
JUP6EH	Protective cover for small armchair	305

Stackable chair with solid iroko frame. The seat can be equipped with a removable cushion.



Structure

raw solid iroko

Seat

iroko veneered beech plywood

Removable cushion

polyester wadding with waterproof lining

Cushion upholstery

removable in fabric

Feet

black plastic

Notes

Note 1

The removable cushion is fixed to the seat by means of two posterior lateral ribbons with steel press studs

Note 2

The furniture of the outdoor collection is designed for covered outdoor spaces, such as verandas, balconies and terraces: when not used, it is recommended to put the appropriate protective cover on the products after their complete drying to prevent the accumulation of moisture and formation of mould

Phill	A	A ₀	B	B ₀	C	D	E	E ₁	G	G ₂	V
	Trame										
	Vancouver										
	Sorrento	●									
	Sorrento rigato	●									
	Ecopelle										
	Trentino Stretto										
	Vancouver										
	Ambro	●									
	Bielastico Color										
	Bielastico Optical										
	Brecon										
	Corda										
	Madrid										
	Oceanic										
	Vancouver										
	Baltimore Plus Eco										
	Hallingdal 2										
	Panno										
	Steelcut Trio										
	Delft Velvet										
	Dunmore Plaid										
	Hardwick Plaid										
	Hero 2										
	Ivyside Herringbone										
	Market Street Plaid										
	Veronnet										
	Zero										
	Chandigar										
	Pelle										
	Pelle Extra										
	Spotted leather										
	Artemidor										
	Pucci Cotton / Velvet										
	Hide										

Code description

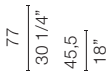

53 20 3/4" 50,5 19" 3/4"

Code	Description	Price
NWL1E	Chair	1.065
NWL1EH	Protective cover for chair	305



40 16" 42 16 3/4"

Code	Description	cat. A ₀	Sorrento rigato	cat. B ₀
NWX1E	Removable seat cushion	210	230	230

Aluminium chair with armrests.



Structure

flat aluminium bars and support rods

Finish

embossed powder coating
 OC1 pure white - RAL 9010
 OC2 violet blue - RAL 5000
 OC3 oxide red - RAL 3009

Removable cushion

polyester wadding with waterproof lining

Cushion upholstery

removable in fabric

Feet

grey felt

Notes

Note 1

The base beams are fastened with AISI 304 stainless steel screws, varnished in the same colour as the structure

Note 2

The removable cushion is fixed to the structure by means of automatic buttons, which allow it to slide between the backrest and the seat. When used on the backrest, the cushion is fastened to the upper side by means of a specific pouch where the extremities of the slats are inserted

Note 3

The furniture of the outdoor collection is designed for covered outdoor spaces, such as verandas, balconies and terraces: when not used, it is recommended to put the appropriate protective cover on the products after their complete drying to prevent the accumulation of moisture and formation of mould

Phil	A	A ₀	B	B ₀	C	D	E	E ₁	G	G ₂	V
	Trame										
	Vancouver										
	• Sorrento										
	• Sorrento rigato										
	Ecoppelle										
	Trentino Stretto										
	Vancouver										
	• Ambro										
	Bielastico Color										
	Bielastico Optical										
	Brecon										
	Corda										
	Madrid										
	Oceanic										
	Vancouver										
	Baltimore Plus Eco										
	Hallingdal 2										
	Panno										
	Steelcut Trio										
	Delft Velvet										
	Dunmore Plaid										
	Hardwick Plaid										
	Hero 2										
	Ivyside Herringbone										
	Market Street Plaid										
	Veronnet										
	Zero										
	Chandigar										
	Pelle										
	Pelle Extra										
	Spotted leather										
	Artemidor										
	Pucci Cotton / Velvet										
	Hide										

Code description



42,5
16 3/4"
74
29 1/4"

54
21 3/4"
68
26 3/4"

Code	Description	Price
VN_5E	Chair	965
VN_5EH	Protective cover for chair	305



32
12 1/2"

46
18"
32
12 1/2"

Code	Description	cat. A ₀	Sorrento rigato	cat. B ₀
VNX5E	Removable seat cushion	165	175	185

kit outdoor
Kit Outdoor

256

Kit Outdoor

Products for the care and the maintenance of outdoor furniture



Cleaning Kit

Kit for the ordinary cleaning of the product.

Each kit contains:

- 1 multipurpose spray cleanser, suitable for all surfaces
- 1 specific cleanser for wood
- 1 cloth
- 1 sponge
- 1 pair of outdoor gloves

Maintenance Kit

Kit for the regular maintenance of the product.

It is recommended to use it twice a year: at the beginning of the season, to prepare the product, and at the end of the season, to replenish the wood.

Each kit contains:

- 1 specific wood cleanser
- 1 impregnation oil
- 1 paintbrush
- 1 cloth
- 1 pair of outdoor gloves

Refitting Kit

Kit for the extraordinary maintenance of the product.

To be used according to the user's need in order to restore the original wood colour.

Each kit contains:

- 1 restoring solution
- 1 impregnation oil
- 1 brush
- 1 paintbrush
- 1 pair of outdoor gloves

Note

Read the table for more details on the use of these products.

Code	description	Price
KIT1C	Cleaning Kit - everyday cleaning	105
KIT1M	Maintenance Kit - regular maintenance	115
KIT1R	Refitting Kit - extraordinary maintenance	145

Progetto Oggetto

Lighting

Arya	<i>Giulio Cappellini & Antonio Facco</i>	258
Big Shadow	<i>Marcel Wanders</i>	260
Cord Lamp	<i>Werner Aisslinger</i>	264
Lampada da Appartamento	<i>Panter & Tourron</i>	266
Meltdown	<i>Johan Lindstèn</i>	267

Accessories

3 Vases	<i>François Azambourg</i>	270
Arya Vase	<i>Giulio Cappellini & Antonio Facco</i>	271
Diavoletti Family	<i>Daniel Eltner & Alessandro Mendini</i>	272
Glass Newson Vase	<i>Marc Newson</i>	273
Jana	<i>Antonio Forteleoni</i>	274
Monofiore	<i>Ronan Bouroullec</i>	275
NewsonVase	<i>Marc Newson</i>	276
Trace	<i>Francesco Forcellini</i>	277
Cross	<i>Thomas Eriksson</i>	279
Off the Moon	<i>Daniel Studio</i>	280
Blue Candleholders	<i>Daniel Studio</i>	281

Lighting device with diffused light, with diffuser in coloured glass mouth-blown on a mould, available in a floor, table or suspended version.



Table lamp structure

metal tube and metal sheet, matt varnished in black colour
black cable and white lamp-holder

Base fixing for table lamp

metal, matt varnished in black colour:
- for small and medium diffuser \varnothing 12 x 1,5 cm
- for big diffuser \varnothing 14 x 1,5 cm

Wall fixing for hanging lamp

metal, matt varnished in black colour:
- for single version \varnothing 10 x 2 cm
- for linear version with 2 diffusers 54 x 3 x 1,5 cm
- for linear version with 3 diffusers 100 x 3 x 1,5 cm
- for cluster version with 3 diffusers \varnothing 54 x 3,5 cm
black cable and white lamp-holder

Floor lamp structure

metal sheet and metal tube, matt varnished in black colour
black cable and white lamp-holder
base \varnothing 40cm

Diffusers dimensions

- small: \varnothing 18 x 23 cm
- medium: \varnothing 27 x 36,5 cm
- big: \varnothing 32 x 51,5 cm

Diffusers finish

white coated matt glass available in four colours:
white
smokey grey
avio blue
chocolate

Notes

Note 1

Bulbs not included
We recommend A 60 11W 230V led bulbs for E27 lamp holder

Note 2

Available cable length for hanging lamps: 2,5 mt

Note 3

The different typologies of linear and cluster lamps are available in unicolour version

Note 4

The lamps are not dimmable

Note 5

The glasses of these lamps are unique pieces, the result of the antique art of Italian Glass Makers. Any air bubbles or differences in colour or thickness, common in handmade glass products, are to be considered qualities

Code description

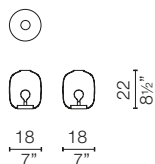

Code	description	Price
PO_2002A	Small table lamp	470

Code description

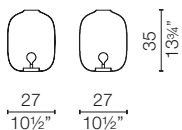

		Price
PO_2002B	Medium table lamp	660

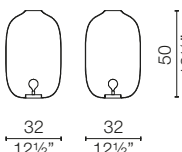

		Price
PO_2002C	Large table lamp	975

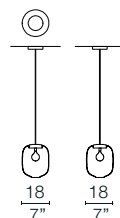

min 90 - max 250
min 35 1/2" - max 98 1/2"

		Price
PO_2003A	Single hanging lamp - 1 small diffuser	540

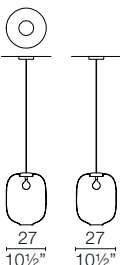

min 90 - max 250
min 35 1/2" - max 98 1/2"

		Price
PO_2003B	Single hanging lamp - 1 medium diffuser	735

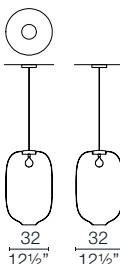

min 90 - max 250
min 35 1/2" - max 98 1/2"

		Price
PO_2003C	Single hanging lamp - 1 large diffuser	995

Code description

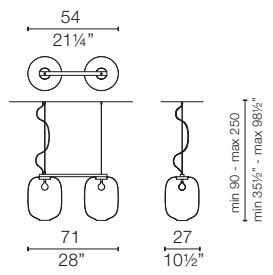

		Price
PO_20052	Linear hanging lamp - 2 medium diffusers	1.395

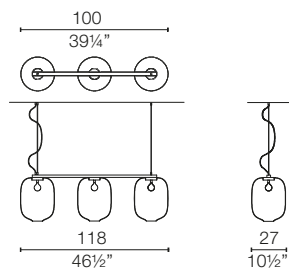

		Price
PO_20053	Linear hanging lamp - 3 medium diffusers	1.975

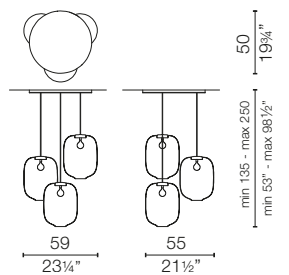

		Price
PO_2004	Cluster hanging lamp - 3 medium diffusers	2.110

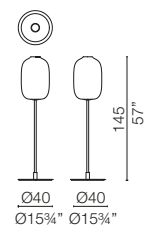

		Price
PO_2006C	Low floor lamp - 1 large diffuser	1.610

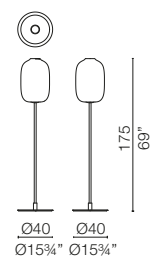

		Price
PO_2005C	High floor lamp - 1 large diffuser	1.675

Floor lighting device with diffused light, available in different dimensions and heights.



Diffuser

structure in chrome painted metal rod with white poliamyde and viscose fabric

Notes

Note 1

Bulbs not included

The following halogen bulbs are suggested:

PO_9811

lampshade max 60W E27 - base max 40W E27

PO_9810

lampshade max 75W E27 - base max 60W E27

PO_9815

lampshade max 100W E27 - base max 75W E27

PO_9812

lampshade max 150W E27 - base max 100W E27

Note 2

White electric feeder cable on white lamp

ON/OFF foot switch on the cable

Code description

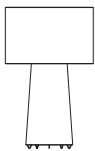

91
35 3/4"

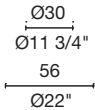

PO_9811 White fabric light lamp

Price

1.230

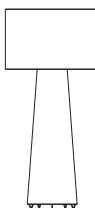

120
47 3/4"

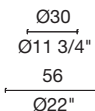

PO_9810 White fabric light lamp

Price

1.315

Big Shadow

design: Marcel Wanders 1998

Code description

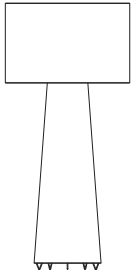
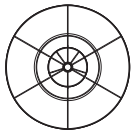

160,5
63 1/4"

Ø41
Ø16 1/4"
Ø75
Ø29 1/2"

		Price
PO_9815	White fabric light lamp	2.690

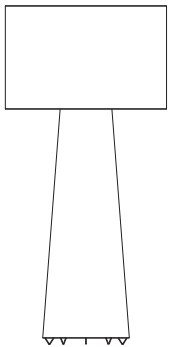
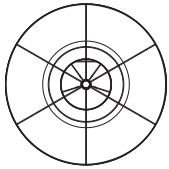

198,5
78 1/4"





Ø50,5
Ø20"
Ø94,5
Ø37 1/4"

		Price
PO_9812	White fabric light lamp	3.675

Big Shadow Bulb Advice

	Bottom Bulb	Top Bulb
Little Big Shadow po/9811	A	B
Big Shadow po/9810	A	B
Middle Big Shadow po/9815	B	C
Extra Big Shadow po/9812	C	D

Bulb type	<i>Incandescent</i> any frosted type	<i>Halogen Retrofit</i> Philips EcoVantage A shape frosted 2700K	<i>Fluorescent</i> Philips Tornado Softone Comp. fluo 2700 K	<i>Fluorescent</i> Philips Softone Esaver 6 years 2700 K	<i>LED</i> Beneito Faure Standard LED 2700 K
A	40 W	29 W	8 W	8 W	6 W
B	60 W	43 W	11W	11W	9 W
C	75 W	53 W	15 W	15 W	11 W
D	100 W	72 W	18 W	18 W	13 W

Hanging lamp, available in two dimensions, with diffuser made up of two shells of striped mouth-blown glass connected by a metal ring.



Wall fixing and structural elements

Metal wall fixing $\varnothing 14 \times h.2,5$ cm
 Metal link between the diffusers:
 - h.2,5 x $\varnothing 22$ cm for small version
 - h.4 x $\varnothing 40$ cm for large version
 black cable, lamp-holder in zinc-coated metal and lamp-holder cover in black metal

Diffusers dimensions

- small version: $\varnothing 22 \times h.22,5$ cm
 - large version: $\varnothing 40 \times h.41$ cm

Diffusers finish

upper part: transparent polish glass in the colours
 amethyst
 emerald green
 avio blue
 steel grey

lower part: transparent polish glass

metal elements: black matt painted

Notes

Note 1

Bulbs not included

Note 2

Small version: the caps are glued to the metal link
 Large version: the caps are fixed together with internal screws; they can be disassembled by means of hexagonal internal pawls

Note 3

For small version: led bulb A 60 11W 230V E27 - it can be inserted through the hole of the lower cap
 For large version: led bulb G 95 ($\varnothing 95$) 20W 230V E27 - it can be inserted through the hole of the lower cap or
 For large version: led bulb G 120 ($\varnothing 120$) 20W 230V E27 - the lower cap has to be disassembled to change the bulb

Note 4

Available cable length for hanging lamps: 2,5 mt

Note 5

The lamps are not dimmable

Note 6

The glasses of these lamps are unique pieces, the result of the antique art of Italian Glass Makers. Any air bubbles or differences in colour or thickness, common in handmade glass products, are to be considered qualities

Code description

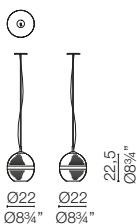

Code	description	Price
PO_2103A	Small hanging lamp	880

Cord Lamp

design: Werner Aisslinger 2021

Code description

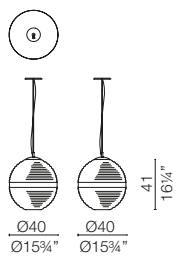

	Price
PO_2103B Large hanging lamp	1.620

Lighting device with diffused light, available in both floor and wall versions, consisting of a vertical metal structure and two metal arches fixed to the source of light, creating a perfect light ring.



Central structure

vertical element, matt lacquered in black colour with two led stripes

Ring structure

two metal arches varnished in metallic blue colour

Colour temperature

3000 K

Luminous flux

1900 lm

Total power

22 W

Power source

plug-in power supply 24V

Switching

Floor lamp: side power button with capacitive metal touch dimmer

Wall lamp: ON/OFF functions by means of foot-switch on cable

Code description

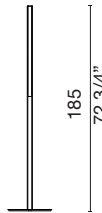
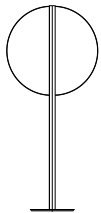
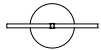

Ø40
Ø15 3/4"
Ø82
Ø32 1/4"

Ø40
Ø15 3/4"

185
72 3/4"

PO_2301 Floor lamp

Price

2.000

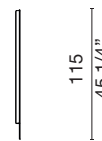
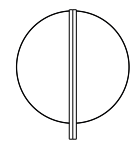

Ø100 4
Ø39 1/2" 1 1/2"

115
45 1/4"

PO_2302 Wall lamp

Price

1.150

Lighting device with diffused light, with diffuser in coloured glass mouth-blown on a mould, available in a floor, table or suspended version. The spheres of the different lamp types can come in a single colour or in a pre-set mix of hues.



Table and floor lamps structure

iron tube and plate, matt varnished in black colour
 cable and lamp-holder in black colour

Wall fixing for hanging lamps

metal, matt varnished in black colour:
 - for single version Ø 11x2 cm
 - for cluster with 4 diffusers Ø 33,8x2 cm
 - for cluster with 8 diffusers Ø 45x2 cm
 cable and lamp-holder in black colour

Diffuser

coloured transparent glass Ø 26,4 x 29,5 cm with diffuser lock in matt black painted aluminium

Diffuser finish

different colours available:

- VT1 amber
- VT2 tobacco
- VT3 dove
- VT4 light blue
- VT5M amethyst
- VT6 pink
- VT7 green

Notes

Note 1

Bulbs not included
 Halogen bulbs suggested max 60W 230V for lamp holder E27

Note 2

Available cable length for hanging lamps: 2,5 mt

Note 3

Upon request, other colour matching than those suggested are available

Note 4

The glass of this lamp is a unique piece, it is the result of the antique art of Italian Glass Makers. Any air bubbles or colour differences, common in handmade glass products, are to be considered qualities

Code description

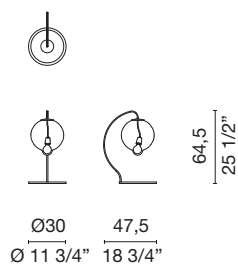

		Price
PO_1401	Single lamp available in the following colours: amber VT1, tobacco VT2, dove VT3, light blue VT4, amethyst VT5, pink VT6, green VT7 diffuser dimension: Ø 26,4 x h 29,5 cm	965

Code description

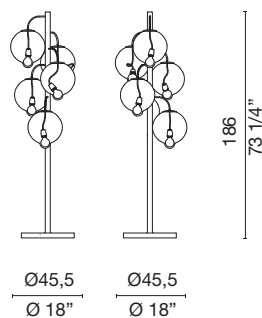

		Price
PO_1402	Cluster lamp with 5 diffusers suggested colour matching:amber VT1, dove VT3, light blue VT4, amethyst VT5, pink VT6 available in one-colour version, 6 colours as price list diffuser dimension: Ø 26,4 x h 29,5 cm	3.175

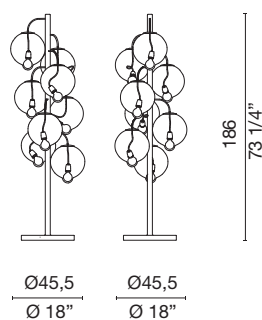

		Price
PO_1403	Cluster lamp with 8 diffusers suggested colour matching: tobacco VT2, pink VT6, dove VT3, amethyst VT5, light blue VT4, amethyst VT5, rosa VT6, amber VT1 available in one-colour version, 6 colours as price list diffuser dimension: Ø 26,4 x h 29,5 cm	4.325

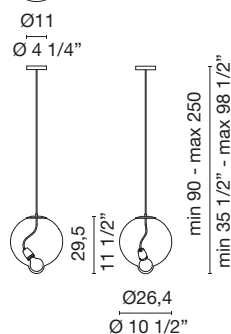

		Price
PO_1301	Single lamp available in the following colours: amber VT1, tobacco VT2, dove VT3, light blue VT4, amethyst VT5, pink VT6, green VT7 diffuser dimension: Ø 26,4 x h 29,5 cm connection dimension: Ø 11 x h 2 cm	600

Code description

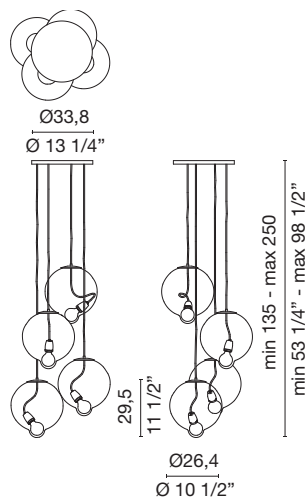

		Price
PO_1302	Cluster lamp with 4 diffusers suggested colour matching: dove VT3 , amber VT1, pink VT6, amethyst VT5, available in one-colour version, 6 colours as per price list diffuser dimension: Ø 26,4 x h 29,5 cm connection dimension: Ø 33,8 x h 2 cm	2.205

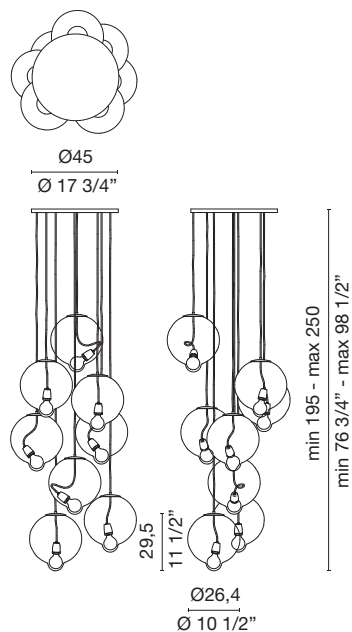

		Price
PO_1303	Cluster lamp with 8 diffusers suggested colour matching: tobacco VT2, pink VT6, dove VT3, amethyst VT5, light blue VT4, amethyst VT5, rosa VT6, amber VT1 available in one-colour version, 6 colours as per price list diffuser dimension: Ø 26,4 x h 29,5 cm connection dimension: Ø 45 x h 2 cm	3.710

Decorative element made of polish ceramic consisting of three vases in different shapes, available in a fixed combination of colours.



Product description

polish ceramic vase

Finish

fixed colour matching according to size

high: white, black and yellow

medium: black and green

low: white and black

Note

This vase has three removable inner flower holders made in ceramic with following dimensions and finishes:

Ø cm 5,2x33,5 H white

Ø cm 7,6x24,5 H black

Ø cm 4,8x24 H white

Code	description
------	-------------

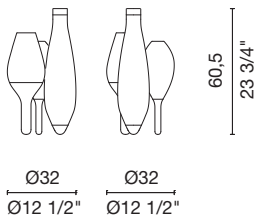

Code	description	Price
PO_0803	Vase	4.170

Collection of vases in coloured glass mouth-blown on a mould, available in three different dimensions.



Finish

white coated polish glass available in three colours:
white
chocolate
avio blue

Note

The glasses of these lamps are unique pieces, the result of the antique art of Italian Glass Makers. Any air bubbles or differences in colour or thickness, common in handmade glass products, are to be considered qualities

Code	description
------	-------------

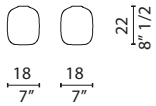

		Price
PO_2001A	Small vase	365

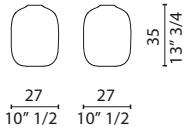

		Price
PO_2001B	Medium vase	580

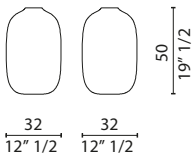

		Price
PO_2001C	Large vase	825

Collection of vases, available in three different sized and colours, inspired by the idols from the Cycladic civilization on the island of Mykonos.









Description

matt ceramic vase, in a unique colour for each version
 Diavoletto: Red RAL 3020
 Diavoletta: Pink RAL 4003
 Diavoletto Baby: Yellow RAL 1023

Note

edge and internal in polished laquered ceramic

Code	description	Price
  18,7 14,9 37,5 7 1/4" 5 3/4" 14 1/2"		
PO_1801	red vase	320
  23,6 13 31 9 1/4" 5" 12 1/4"		
PO_1802	pink vase	315
  19,6 9,7 26,2 7 3/4" 3 3/4" 10 1/4"		
PO_1803	yellow vase	265

Vase in coloured glass mouth-blown on a mould, available in three different contemporary colours, studied to emphasize the curvilinear shape of the design. The vase is also available with a lid with three holes, in the same material and finishes as the main body.





Finish

polish transparent glass in three colours:

- amethyst
- emerald green
- avio blue

Note

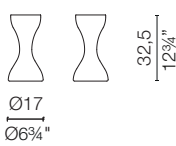
The glasses of these lamps are unique pieces, the result of the antique art of Italian Glass Makers. Any air bubbles or differences in colour or thickness, common in handmade glass products, are to be considered qualities

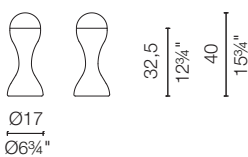
Code	description	Price
 		
PO_9369V	Vase	685
 		
PO_9369T	Vase with lid	965

Stoneware vases offered in two different shapes and dimensions, hand-worked on the lathe.



Outside finish

raw black gres

Inside finish

enamelled

Feet

black felt pad

Note

These vases are shaped at potter's wheel, fruit of the ancient art of ceramic Masters. Any surface irregularities and colour differences should be considered qualities

Code description

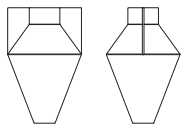

34,7
13 3/4"

Ø22,6 Ø22,6
Ø 9" Ø 9"

PO_1409A Vase

Price

660

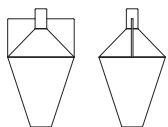

85,5
14"

Ø20 Ø20
Ø 7 3/4" Ø 7 3/4"

PO_1409B Vase

black gres

660

White polycarbonate one-flower vase.

Product description

white polycarbonate one-flower vase



Code description



Ø14,7
Ø5 3/4"

		Price
PO_9918	Vase	140

Vase with three-hole lid made of polish ceramic.



Product description

vase made of ceramic

Finish

white polish ceramic

Notes

Note 1

The vase has a lid in ceramic with three holes

Note 2

The vase can be used for flowers with our without the lid

Code description

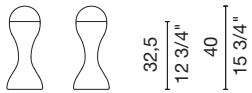

Ø17
Ø6 3/4"

Code	description	Price
PO_9369	Vase	335

Series of vases made of ceramic with an irregular checkered texture, the outcome of a perfect combination of artisan manufacture and 3D printing technology.



Finish

white ceramic RAL 9010
 matt finish on the outside, polish enamelled coating on the inside

Code	description
------	-------------

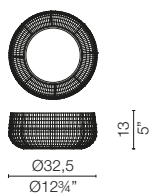

PO_2101A	Bowl	Price
		260

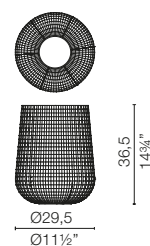

PO_2101B	Large vase	Price
		325

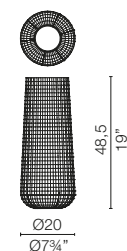

PO_2101C	High vase	Price
		300

Code description

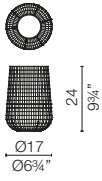

		Price
PO_2101D	Small vase	250

Wall-mounted metal cabinet.



Product description

cabinet in laser-cut and bent metal plate
 door in metal plate with magnetic lock

Finish

embossed powder coating
 5BI pure white RAL 9010
 5RO traffic red RAL 3020
 5BL traffic blue RAL 5017

Code description

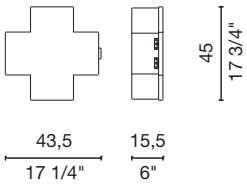

Code description		Price
PO_9208B	Cabinet	855

Brass tray with rod handle and decorative sphere.



Finishes

brass Copper rose polished finish

Feet

blacks felt pads

Code description

⊖

 30
 11 3/4"

		Price
PO_1702	Tray	1.395

Candle holders made of curved rod and sheet metal with metal base.



Finishes

indigo blue painted glossy

Feet

blacks felt pads

Code description

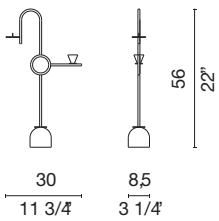

PO_1703 Candle-holder

Price

1.125

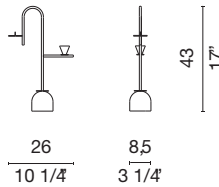

PO_1704 Candle-holder

Price

990

finishes and weights

Finishes	285
Fabrics and leathers	289
Outdoor fabrics and finishes	297
Fabrics and leathers suitability	298
Fabrics and leathers - technical features	300
Fabrics - washing instruction and fabric care	301
Weight Table	302

Finishes

						
	01 white	46 magnolia	59 beige	60 desert	07 light grey	48 anthracite
						
	04 black	71 mud	93 straw yellow	78 pumpkin	45 chestnut brown	47 fog
						
	10 dark grey	95 powder pink	96 terracotta	53 orange	94 brick-red	55 red
lacquers						
	54 bordeaux	84 aquamarine	81 jade	92 sage green	18 powder green	56 dark green
						
	76 english green	77 blue-green	91 sky blue	11 cloud	80 lapis	44 china blue
						
	49 india blue					
melamine						
220N desert melamine						

Finishes

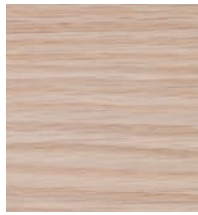

133 natural oak



158 black-stained oak



113 bleached ash



116 oak-stained ash

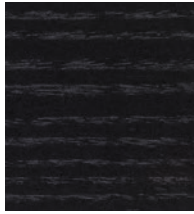

112 black-stained ash



118 blue shanghai aniline stained ash

woods

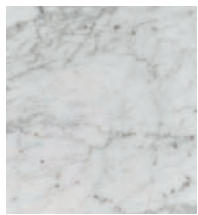

521 white carrara



528 grey roma

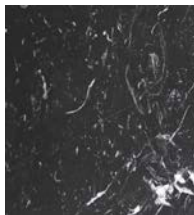

523 black marquinia



526 green alps

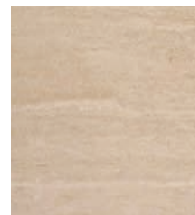

527 light straw-yellow travertine

marbles

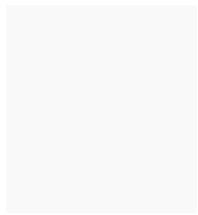

01 white

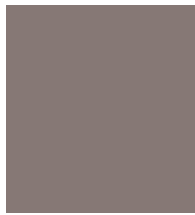

71 mud



04 black

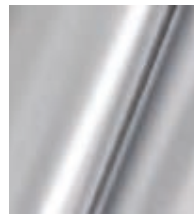

407 chromed



410 anodised aluminium



412 polish aluminium

metals



435 satined stainless steel



A41



A44

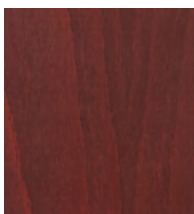

A45

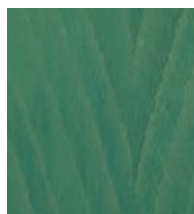

A46



A47



A48

Tate Color

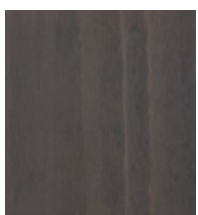



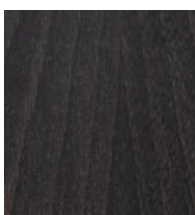





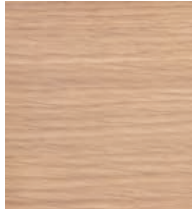
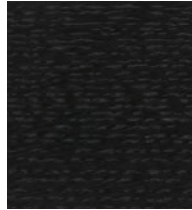
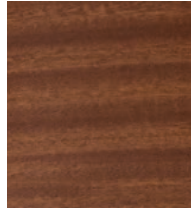
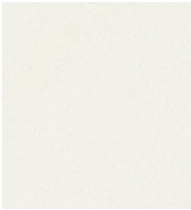





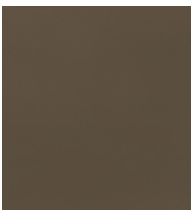

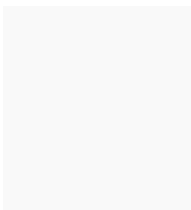

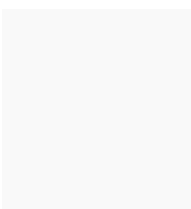

A42



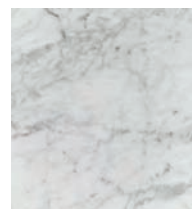









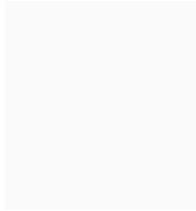

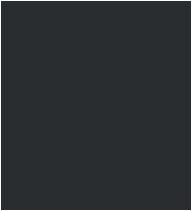
A43

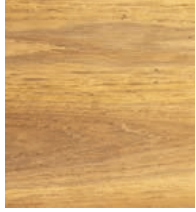
Finishes

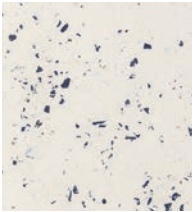
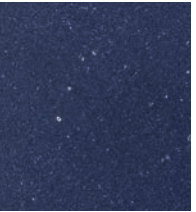
Tate Wood						
	155 white-stained oak	133 natural oak	158 black-stained oak	164 mahogany		
Tate metals						
	01 - RAL9010	24 - RAL1024	10 - RAL3016	14 - RAL6000	26 - RAL6026	17 - RAL5007
Tate metals						
	71 - RAL7006	04 - RAL9005				
fiberglass						
	806 white	802 orange	803 red	805 blue	807 black	
Bong						
	V19 white	V26 orange	V24 red	V31 black	V20 volcanic lava	V29 white carrara
Bong Lux						
	floral decoration					
Gong Lux						
	metallic blue	brass				

Finishes

						Gong Circus
01 white / 04 black	green RAL6021 / RAL6002	red RAL3016 / RAL3011				
						
RAL9010 white	RAL2002 orange	RAL5007 blue	RAL9011 black	RAL6016 green	RAL7006 mud	
						Mush
160 cognac oak	161 carbon oak	marble mixture white with blue	marble mixture blue with aluminium			
						Thinking Man's Chair
OC1 pure white RAL 9010	OC2 violet blue RAL 5000	OC3 oxide red RAL 3009				

Colour samples are purely indicative, not being possible the faithful reproduction when printed

Fabrics and leathers



phill 900



phill 901



phill 903



phill 102



phill 104



phill 600



phill 807



phill 808



phill 809



phill 810

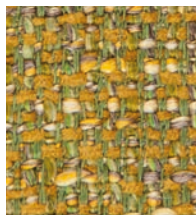

trame A210

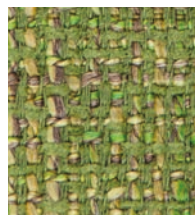

trame A150

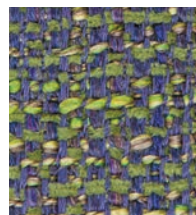

trame A190



trame A180

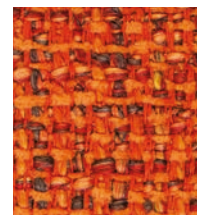

trame A120



trame A030



trame A050



trame A070



trame A110

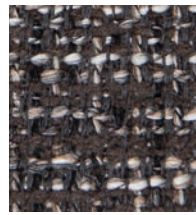

trame A100



vancouver A109



vancouver A105

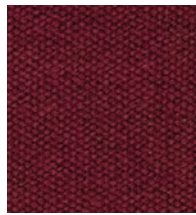

vancouver A118



vancouver A108

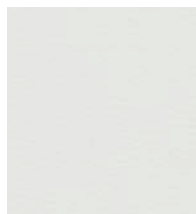

ecopelle 13P108

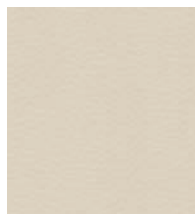

ecopelle 13P109

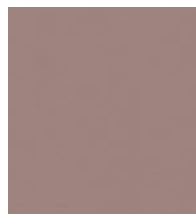

ecopelle 13P100



ecopelle 13P113



ecopelle 13P110



ecopelle 13P132



ecopelle 13P118

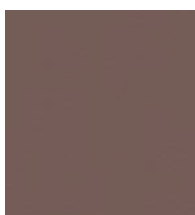

ecopelle 13P101



ecopelle 13P133



ecopelle 13P106



ecopelle 13P125











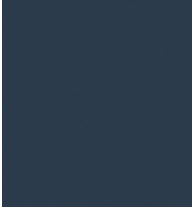



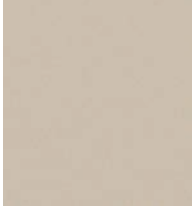
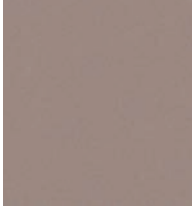

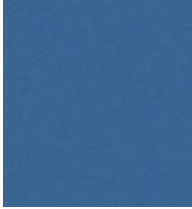

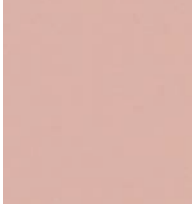

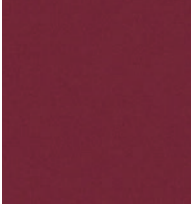





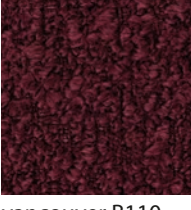

ecopelle 13P122

cat.
A

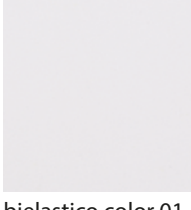
cat.
B

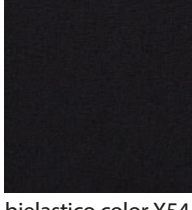
Fabrics and leathers

						
	ecopelle 13P102	ecopelle 13P123	ecopelle 13P103	ecopelle 13P134		
						
	trentino stretto 710	trentino stretto 713	trentino stretto 711	trentino stretto 702	trentino stretto 720	trentino stretto 723
						
	trentino stretto 722	trentino stretto 724	trentino stretto 728	trentino stretto 733	trentino stretto 731	trentino stretto 727
cat. B						
	trentino stretto 717	trentino stretto 718	trentino stretto 719			
						
vancouver B126	vancouver B125	vancouver B124	vancouver B121	vancouver B120	vancouver B102	
						
	vancouver B110	vancouver B111				
cat. C						
	bielastico color 01	bielastico color 16	bielastico color X54	bielastico color 87		

Fabrics and leathers

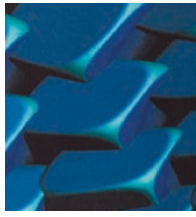

bielastico optical SBL



bielastico optical SRO



bielastico optical SBI



brecon 201



brecon 203



brecon 206



brecon 205



brecon 204

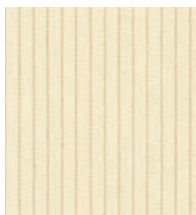

corda 321

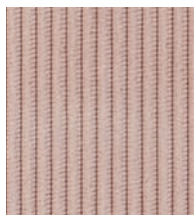

corda 317



corda 310

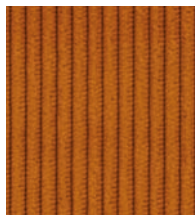

corda 313



corda 307

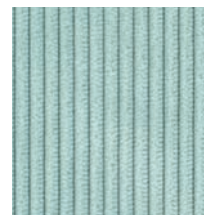

corda 304

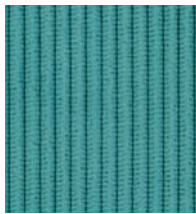

corda 305

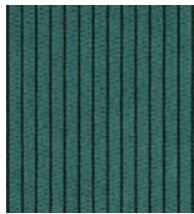

corda 306



corda 303

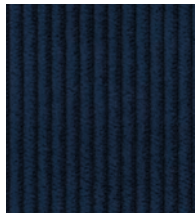

corda 302



corda 320

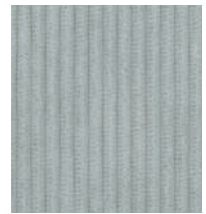

corda 322



corda 319



corda 318

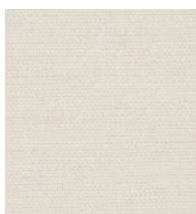

madrid 717

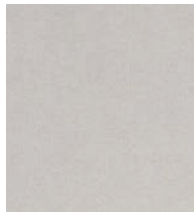

madrid 723



madrid 728



madrid 725



madrid 732



madrid 713



madrid 710



madrid 707



madrid 703



madrid 701





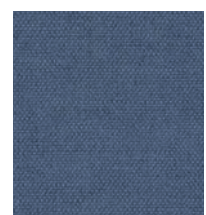









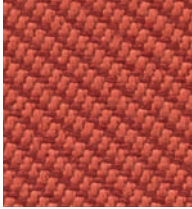
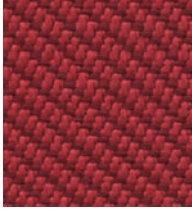

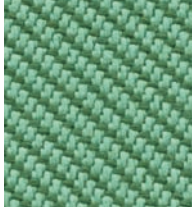
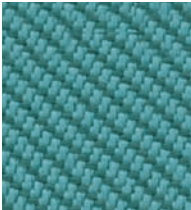

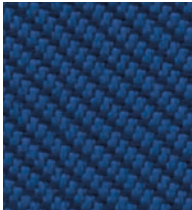

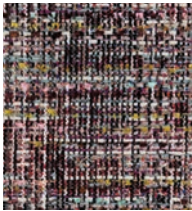

madrid 704

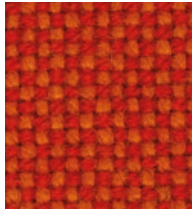
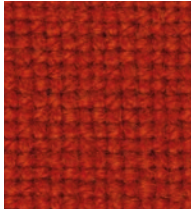

madrid 702

cat.
C

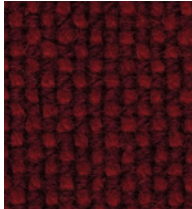
Fabrics and leathers

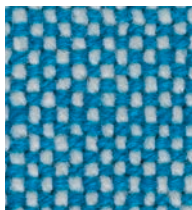
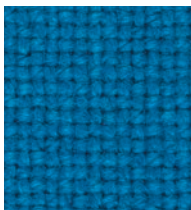
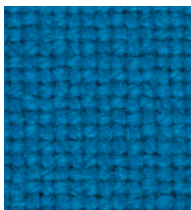
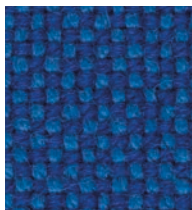
							
	madrid 727						
cat. C							
	oceanic 516	oceanic 512	oceanic 510	oceanic 513	oceanic 515	oceanic 504	
							
	oceanic 502	oceanic 511	oceanic 506	oceanic 514	oceanic 508	oceanic 501	
							
	vancouver C401	vancouver C404	vancouver C408	vancouver C407			
							
	baltimora eco plus 136						
	cat. D						
		hallingdal2 407	hallingdal2 565H	hallingdal2 561	hallingdal2 566H	hallingdal2 657H	hallingdal2 687
							
		hallingdal2 575H	hallingdal2 568H	hallingdal2 840	hallingdal2 576H	hallingdal2 723H	hallingdal2 556

Fabrics and leathers



hallingdal2 569H

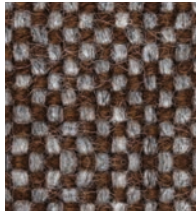

hallingdal2 571H



hallingdal2 573H



hallingdal2 555



hallingdal2 554



hallingdal2 574H

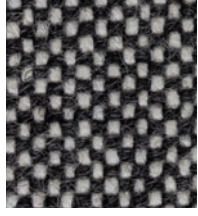

hallingdal2 126

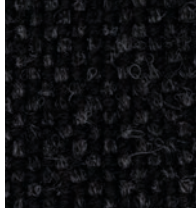

hallingdal2 553



panno 457



panno 458



panno 459



panno 440



panno 461



panno 441

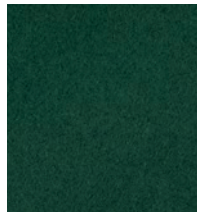

panno 442

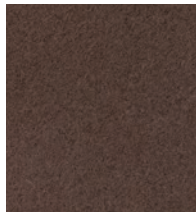

panno 443



panno 444



panno 445



panno 465



panno 463



panno 466

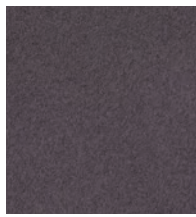

panno 446

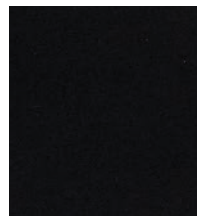

panno 469



steelcut trio 205



steelcut trio 246



steelcut trio 253



steelcut trio 376

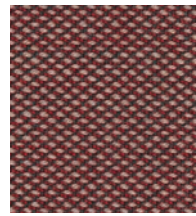

steelcut trio 645

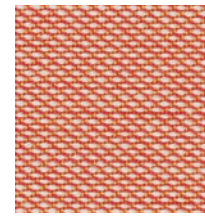

steelcut trio 515

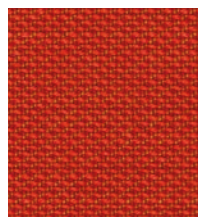

steelcut trio 533

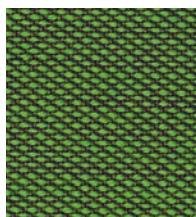

steelcut trio 953

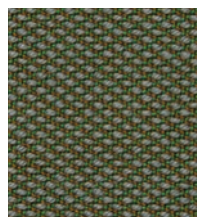

steelcut trio 946

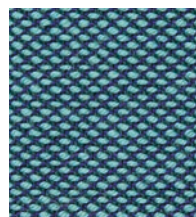

steelcut trio 983



steelcut trio 883

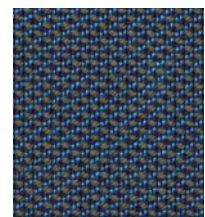

steelcut trio 756

cat.
D

Fabrics and leathers

cat.
D

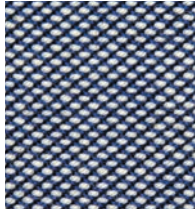

steelcut trio 716

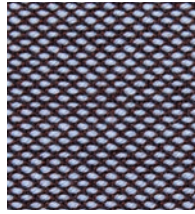

steelcut trio 336



steelcut trio 124



hero2 800



hero2 801



hero2 802



hero2 804



hero2 805



hero2 806



hero2 807



hero2 812



hero2 814



zero EZ01

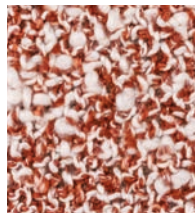

zero EZ08



zero EZ09



zero EZ11

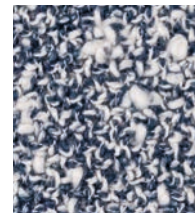

zero EZ05

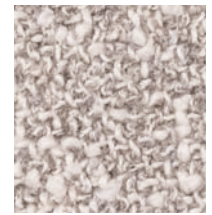

zero EZ12

cat.
E



zero EZ04



decoration
veronnet 301



decoration
delft velvet 601



decoration ivyside
herringbone 620



decoration
dunmore plaid 625

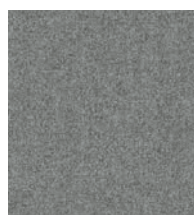

decoration ivyside
herringbone 623



decoration market
street plaid 627



decoration
hardwick plaid 626

Fabrics and leathers



decoration
chandigarh 102

cat.
E1

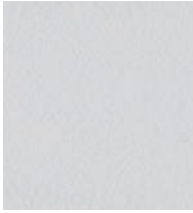

pelle 900



pelle 269



pelle 326



pelle 201



pelle 332



pelle 333

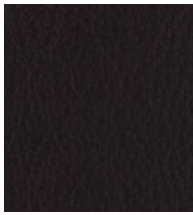

pelle 915



pelle 335



pelle 338

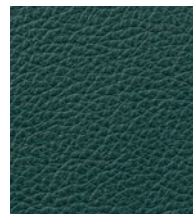

pelle 337

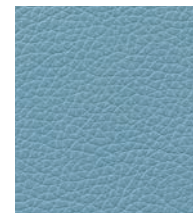

pelle 336



pelle 341

cat.
G

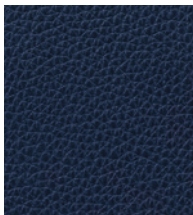

pelle 342



pelle 295



pelle 290



pelle 276



pelle 334

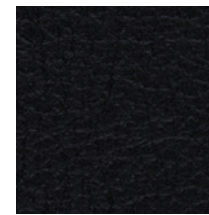

pelle 908



pelle extra 981



pelle extra 984

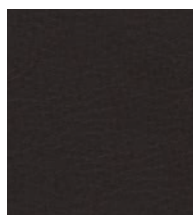

pelle extra 982



pelle extra 983

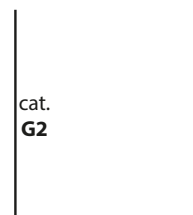

cat.
G2



spotted leather

cat.
V



CP4



CP1



CP5



CP3



CP2















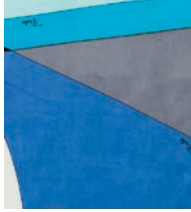





hide



decoration
artemidor 1003

wool

Fabrics and leathers

Pucci	 cotton L03	 cotton L04	 cotton L05	 velvet M01	 velvet M02	
Proust	 PR_1	 PR_2	 PR_3			
Peacock	 1710 green	 1713 blue				
Embroidery Chair	 EMB1 winter	 EMB2 spring				
	 EMB3 summer	 EMB4 autumn				
gros-grain	 135 corda	 168 castoro	 88 amaranto	 173 avio	 114 abisso	 41 nero

Colour samples are purely indicative, not being possible the faithful reproduction when printed

Outdoor fabrics and finishes

cat. A	sorrento rigato		02E	03E	04E	
	sorrento A01E					
cat. B	ambro B01E	ambro B02E	ambro B03E	ambro B04E	rope	B05E
metals	435 satin stainless steel	OC1 pure white RAL9010	OC2 violet blue RAL5000	OC3 oxide red RAL3009	woods	189 iroko
marble	521 white carrara	lava stone	602 bleu	603 bordeaux	ceramic	CBI white
Bong Lido	OC1 pure white RAL9010	OC2 violet blue RAL5000	OC3 oxide red RAL3009		Juli Re-Plastic Lido	JRE gray
fiberglass	806 white	802 orange	803 red	805 blue	807 black	

Colour samples are purely indicative, not being possible the faithful reproduction when printed

Fabrics and leathers suitability

	A	A ₀	B	B ₀	C	D	E	E ₁	G	G ₂	V																									
	Phill	Trame	Vancouver	Sorrento	Sorrento rigato	Ecopelle	Trentino Stretto	Vancouver	Ambro	Bielastico Color	Bielastico Optical	Brecon	Conda	Madrid	Oceanic	Vancouver	Baltimore Plus Eco	Hallingdøl 2	Panno	Steelcut Trio	Delft Velvet	Dunmore Plaid	Hadwick Plaid	Hero 2	Ivyside Herringbone	Market Street Plaid	Veronnet	Zero	Chandigar	Pelle	Pelle Extra	Spotted leather	Artemidor	Pucci Cotton / Velvet	Hide	
OUTDOOR SOFAS / ARMCHAIRS																																				
Litos Lido			•	•					•																											
Newood Relax Lido			•	•					•																											
Vendicari Lido			•	•					•																											
Cushions			•	•					•																											
OUTDOOR CHAIRS / STOOLS																																				
Newood Light Lido			•	•					•																											
Vendicari Lido			•	•					•																											

A₀ / B₀ outdoor fabrics

- Suitable / ○ Suitable only for some items - see product sheet

prices in euro VAT not included

Fabrics and leathers - technical features

CAT.	FABRIC LEATHER	COMPOSITION	H cm	WEIGHT gr/sqmt	FADING	MARTINDALE	PILLING	WASHING INSTRUCTION	SHRINK	ECOLABEL OEKO-TEX	IMO	FIREPROOF
A	PHILL	32% PL 52% PP 10% VI 6% LI	140	286	4	18000			1%			
	TRAME	55% PL 45% AC	140	647	6	40000	4					
	VANCOUVER	100% CO	140	620		30000						
A ₀	SORRENTO	64% PP 36% PL	140	430		35000	5					
	SORRENTO RIGATO	64% PP 36% PL	140	430		35000	5					
B	ECOPELLE	87,5% PVC 12,5% CO	140									
	TRENTINO STRETTO	100% PL	145	310		100000						
	VANCOUVER	47% PC 22% PL 11% VI 20% CO	140	1000		40000						
B ₀	AMBRO	100% PP	140	485	7-8	30000	5					
C	BIELASTICO COLOR	80% PA 20% EA	150									
	BIELASTICO OPTICAL	100% PL	150									
	BRECON	43% LI 21% PC 11% WO 11% PL 7% CO 7% SE	140	450		40000						
	CORDA	100% CO	148	313		70000						
	MADRID	78% CO 22% VI	140	478		45000						
	OCEANIC	100% recycled PL	140	497		100000	3					
	VANCOUVER	36% CO 32% PL 26% PC 6% VI	142	900		25000						
D	BALTIMORA PLUS ECO	60% PA 25% PL 14% PU	130	410		50000						
	HALLINGDAL 2	70% WV 30% VI	130	612	5-7	100000	3					
	PANNO	100% WV	150	547	5-7	45000	3					
	STEELCUT TRIO	90% brushed WV 10% PA	140	550	5-7	100000	3-4					
E	DELFT VELVET	66% CO 31% VI 3% PL	137	442		50000						
	DUNMORE PLAID	70% WO 25% PA 5% AF	140	393		40000						
	HARDWICK PLAID	100% WO	150	313		25000						
	HERO 2	97% WV 3% recycled PA	140	414	5-7	45000	3-4					
	IVYSIDE HERRINGBONE	100% WO	140	335		20000						
	MARKET STREET PLAID	70% WO 25% PA 5% AF	140	393		40000						
	VERONNET	100% LI	136	230								
ZERO	65% CO 20% PC 15% PL	140	74		70000							
E1	CHANDIGARH	68% PL 32% VI	144	487		40000						
G	PELLE		> 4.8 mq		5							
G2	PELLE EXTRA		> 4.5 mq		3							
V	SPOTTED LEATHER	shoulder cow hide 2,5 - 3 mm										
	HIDE	shoulder cow hide 2,5 - 3 mm aniline treatment										
	ARTEMIDOR	41% WP 41% WO 18% CO	140	860		36000						

Fabrics - washing instruction and fabric care

Symbols

	Symbols description and definition
	Washing
	Bleaching
	Ironing
	Dry cleaning
	Tumble dry
	Treatment not allowed The cross placed on any of the above treatments states that such treatment is not allowed.
	Moderate treatment The bar underneath the washing and the dry cleaning means that the treatment has to be more moderate compared of the treatment without the bar.
	Very moderate treatment The interrupted bar underneath the washing means that the treatment has to be very moderate at 40° C
	Ecolabel UE
	OEKO-TEX®
	IMO certified
	Fire resistant

Ironing

	Ironing - the iron indicates household ironing. High levels of temperature are indicated from 1, 2 or 3 points placed inside of the symbol.
	- ironing at hot temperature: 200°C
	- ironing at medium temperature: 150°C
	- ironing at low temperature: 110°C - vapor ironing can be dangerous
	- do not iron - steam ironing not allowed

Dry cleaning

	Dry cleaning - the circle indicates dry cleaning for textile items (leather and fur items excluded). It gives informations for dry cleaning operations.
	- dry cleaning with all solvents normally used in the dry cleaning, solvents indicated for P sign, trichloroethylene and 1.1.1-trichloroethane included
	- dry cleaning with tetrachloroethylene, monofluoro-trichloromethane, solvents indicated for F sign - regular washing treatments, without restrictions
	- dry cleaning with solvents indicated to the previous point - rigorous restrictions to the addition of water and/or stress action and/or washing and/or dry cleaning temperature - dry cleaning not allowed in launderette
	- dry cleaning with trifluorotrichloroethane, hydrocarbons (boiling point between 150° C and 200° C, inflammability point between 38° C and 60° C) - treatments of regular washing, without restrictions
	- dry cleaning with solvents indicated to the previous point - rigorous restrictions to the addition of water and/or stress action and/or washing and/or dry cleaning temperature - dry cleaning not allowed in launderette
	- dry cleaning not allowed - solvents not allowed

Washing instruction

	Temp. max	Action	Rinsing	Drying	Various
	95°	regular	regular	regular	
	95°	moderate	step by step decreasing temperature (for cold water step by step immersion)	moderate	
	70°	regular	regular	regular	
	60°	regular	regular	regular	
	60°	moderate	step by step decreasing temperature (for cold water step by step immersion)	moderate	
	50°	moderate	step by step decreasing temperature (for cold water step by step immersion)	moderate	
	40°	regular	regular	regular	
	40°	moderate	step by step decreasing temperature (for cold water step by step immersion)	moderate	
	40°	hVtk _ aVWdSFw	dWg'Sd	dWg'Sd	Va`af i d' Y agf
	30°	hVtk _ aVWdSFw	dWg'Sd	_ aVWdSFw	
	40°	- ZS`Vi SeZ`a`k - `a`_SUZ`W SeZ`Y - ZS`VWV`fZ`LSdW			
		- Va`afi`SfVdi`SeZ` - [XVS`bi`ZS`VWV`fZ`LSdW			
		4`VBLZ`Y`fZ`WdS`Y`W`V`LSfV`LZ`ad`W`VBLZ`Y`fd`Bf`W`f			
		S`ai`W`Za`k`V`grWV`i`fZ`Lb`Vi`SfVd			
		`af`S`ai`W			

6dk`Y

	Fg`T`Wck`-fZ`WU`d`V`eU`T`W`fZ`V`ecg`SdM`V`LSfV`fg`T`W`ck`SfVdS`i`SeZ`Y`ab`VdS`f`a`z`[YZ`M`W`e`a`X`V`d`Y`efd`W`e`SdM`V`LSfV`X`b`_`#`ad`\$`ba`f`e`b`S`U`W`[`e`V`W`b`X`Z`V`e`k`_`Ta`^
	- Va`af`eb`Z`ck
	- fg`T`W`ck`S`ai`W` - d`W`g`S`d`V`k`b`d`Y`c`S`_`W`
	- fg`T`W`ck`S`ai`W` - _`a`V`W`d`S`F`W`d`k`b`d`Y`c`S`_`W`
	- fg`T`W`ck``af`S`ai`W`
	- f`W`ck`Z`S`Y`W`fi

Outdoor

	i`SfVd`W`V`W`V`f`S`V`efS`Z`b`d`a`X
	_`a`V`d`W`e`S`f`
	L`a`d`X`e`f`V`e`e`
	T`d`B`f`Z`S`T`W`
	V`e`k`f`a`U`V`S`

Weight Table

Product	cod.	Net weight kg
CABINETS & BOOKSHELVES		
Aliante	ALI2	41,0
	ALI3	53,0
Bookshelf	PC_7	280,0
Cloud	C5_1	22,0
Dinah	PC_20	70,0
Drop	DR_1	36,5
	DR_2	40,5
	DR_3	48,0
Easy	EAS4	87,5
	EAS11	90,2
	EAS3	131,5
	EAS20	143,5
Top Easy marble	135 cm	33,0
	180 cm	46,0
	240 cm	58,0
Top Easy wood	135 cm	7,5
	180 cm	11,0
	240 cm	14,5
Homage to Mondrian	PC_19	100,0
	PC_18	110,0
Lochness	LH_1	124,0
	LH_2	108,0
	LH_3	160,0
Luxor	LX_17	151,8
	LX_8	68,0
	LX_3	110,0
	LX_15	115,0
	LX_16	150,0
	LX_18	211,3
Progetti Compiuti	LX_19	146,0
	PC_3	100,0
	PC_6	110,0
	PC_8	150,0
Pyramid	PC_12	250,0
	PC_16	108,0
Revolving Cabinet	PC_15	65,0
Simplon	S8_S1B	90,0
Uni	UN_2BQ	127,0
	UN_5Q	109,0
	UN_6Q	131,0
	UN_9Q2 - UN_9Q	52,0
	UN_7Q	200,0
	UN_8Q	245,0
TABLES & SERVICE TABLES		
Bac	BAC1	32,0
	BAC2	35,0
	BAC4	23,0
Bambi	BM_1	18,0
Bong	BG_1	4,5
Branch Table	BR_1LA	32,0
	BR_1LE	32,0
	BR_1V - VR - VS	60,0
	BR_3LA	50,0
	BR_3LE	50,0
	BR_3V - VR - VS	60,0
	BR_2LA	47,0

Product	cod.	Net weight kg
	BR_2LE	47,0
	BR_2V - VR - VS	96,0
	BR_5LA	42,0
	BR_5LE	42,0
	BR_5V - VR - VS	75,0
	BR_6LA	94,0
	BR_6LE	94,0
	BR_6V - VR - VS	192,0
Break wood	BE_2AL	49,0
	BE_3AL	50,0
	BBE1AL	62,0
	BBE2AL	63,0
	BBE3AL	100,0
Break marble	BE_2AL	65,0
	BE_3AL	80,0
	BBE1AL	90,0
	BBE2AL	90,0
	BBE3AL	100,0
Cannot	CI_1	7,0
Dolmen	DOL_1	550,0
	DOL_2	490,0
Fronzoni '64	FR_21	21,0
	FR_26	24,0
	FR_27	52,0
Gong	GG_1	13,5
	GG_2	30,0
Gong Circus	GG_1C	13,5
Gong Lux	GG_1G	13,5
	GG_2G	30,0
Ko-Ko	PC_14	10,0
Lochness	LH_5	75,0
	LH_6P	95,0
	LH_7P	120,0
	LH_8L - LH_8R	115,0
	LH_9L - LH_9R	80,0
	LH_10L - LH_10R	105,0
Loop	LP_21	22,0
Luce	LUX1	24,0
	LUX2	19,0
	LUX3	14,0
Luxor	LX_1	79,0
	LX_2	108,0
Millenium Hope	MH_1R	20,0
	MH_2RP	96,0
Mini Bottle	BTL4CE	14,5
Miya	MYA1	36,0
	MYA2	48,0
Mush	MU_1M - MU_1R	18,0
	MU_2M - MU_2R	20,0
	MU_1C	28,0
	MU_2C	30,0
Openup	TOU1	44,0
	TOU2	50,0
	TOU3	45,0
	TOU4	55,0
Org	OG_2	19,0
	OG_5	14,0

Weight Table

Product	cod.	Net weight kg	
Orgone	MN_5	33,0	
Riga	MN_51	38,0	
Simplon	S8_T1	27,0	
	S8_T2	25,0	
	S8_T4	42,5	
	S8_P1 wood	32,0	
	S8_P1 marble	74,0	
Smoke	SM_1	53,0	
	SM_2	35,0	
Thin Black Table	TBT1	3,5	
SOFAS & AMRMCHAIRS			
And	DN_1	45,0	
	DN_2	26,0	
	DN_3	60,0	
Basket	BKT1	32,0	
	BKT2	52,0	
	BKT3	62,0	
	BKT4H	56,0	
	BKT2H	60,0	
Big Sofa	PBS1	80,0	
	PBS2	100,0	
Cap Martin Sunset	MS_2	75,0	
	MS_3	105,0	
	MS_4L - MS_4R	40,0	
	MS_5L - MS_5R	70,0	
	MS_6L - MS_6R	50,0	
	MS_6OL - MS_6OR	75,0	
	MS_7	40,0	
	MS_8	70,0	
	MS_14	105,0	
	MS_1	30,0	
	MS_9	65,0	
	MS_10	95,0	
	MS_50	1,2	
	MS_60	1,4	
	Capo	CP_1	27,0
		CP_2	8,0
Cuba 25	CUS1	46,0	
	CUS2	51,0	
	CUS4	56,0	
	CUS41	67,0	
	CUS5	61,0	
	CUS51	75,0	
	CUS22 - CUS23	36,0	
	CUS24 - CUS25	40,0	
	CU_254 - CU_255	48,0	
	CUS30	28,0	
	CU_253	32,0	
	CUS32	28,0	
	CU_256	28,0	
	CUS37	25,0	
	CUS38	28,0	
	CU_25	2,0	
Cuba 25 Sofa-Bed	CUS10	73,0	
	CUS13	84,0	
Dalia	DL_1	50,0	
	DL_1R	70,0	

Product	cod.	Net weight kg
Daybed	DB_1	45,0
	DB_2	40,0
	DB_68	1,0
	DB_51	1,0
Drum	DB_40	1,0
	DRU6F	40,0
	DRU6 - DRU6R	42,0
	DRU1	35,0
	DRU2	17,0
Elan	DRU5	7,5
	EN_12	41,0
	EN_11	45,0
	EN_1	50,0
	EN_2	69,0
Elan 23	EN_3	67,0
	EN_4	77,0
	EN_5	80,0
	EN_15	12,0
	EVE12	39,0
	EVE2	65,0
	EVE4	73,0
	EVE5	76,0
	EVE6-EVE7	71,0
	EVE8L-EVE8R	76,0
Embroidery Chair	EMB1 - 2 - 3 - 4	12,5
Embryo Chair	EC_1	20,0
Felt Chair	FC_1L	20,0
Fronzoni '64	FR_41	31,0
Gambetta	GM_2	32,0
	GM_8	50,0
	GM_4	39,0
	GM_5	54,0
	GM_9	23,0
Hiroi	HR_1	6,5
Hobo Contract	HOB40	115,0
	HOB41 - HOB42	110,0
	HOB43 - HOB44	56,0
	HOB45 - HOB46	45,0
	HOB50	112,0
	HOB51 - HOB52	100,0
	HOBP3	20,0
	HOBP4	35,0
Inout	IO_1S	112,0
	IO_2S	65,0
Knotted Chair	KC_1	2,0
Litos	LT_1 - LT_5	54,0
	LT_1B - LT_5B	57,0
	LT_2 - LT_6	73,0
	LT_2B - LT_6B	76,0
	LT_3 - LT_7	84,0
	LT_3B - LT_7B	87,0
	LT_4 - LT_8	102,0
	LT_4B - LT_8B	105,0
	LT_9	90,0
	LT_10	86,0
	LT_10BL - LT_10BR	89,0
LT_11 - LT_12	65,0	

Weight Table

Product	cod.	Net weight kg
	LT_13	46,0
	LT_14 - LT_15	46,0
	LT_45 - 55 - 70	1,0
Lotus (Attesa)	LS_1	14,5
	LS_1CB	17,0
Low Pad	LW_1	12,0
	LW_3	12,5
Lud'o Lounge	LU_1	6,0
	LU_2	37,0
	LU_4	27,0
Newood Relax	NW_3R	12,0
Newood Relax Light	NWX3R	12,0
Orgone	MN_4	35,0
Orla	ORL4	20,0
	ORL4G	30,0
	ORL1	20,0
	ORL1G	35,0
	ORL2	48,0
	ORL2S	30,0
	ORL3	57,0
	ORL6 - ORL5	65,0
	ORL7	24,0
Peacock	PCK1	30,0
Peg Armchair	PEG2R	11,0
Proust	PR_1 - PR_2	23,0
Proust Geometrica	PR_3	23,0
Rive Droite	RD_3 - RD_4 - RD_5	26,0
Serie 3088	M3088	28,0
Sofa with Arms	PC_17	15,0
Spring	SG_1T	18,0
Sunset	SU_11	34,0
Thinking Man's Chair	TM_1 - TM_2	12,5
Three Sofa de Luxe	TSA3	24,0
	TSA4	40,0
	TSA5	40,0
	TSA6	34,0
	TSA7	47,0
Tube Chair	TUC1	25,0
W. Tulip Armchair	TL_1	92,0
Wooden Chair	MN_30	9,5
Cuscini	CM_40	0,6
	CM_50	0,7
	CM_60	0,8
	CM_70	1,0
CHAIRS, STOOLS & SMALL ARMCHAIRS		
01 Chair	PC_22	10,0
Alodia	LD_1	9,5
	LD_2	10,0
Bac	BAC3	4,5
	BAC3R	5,5
Cap Chair 2	CAP2CP	15,0
	CAP2CPB	14,5
Fronzoni '64	FR_11	7,0
Hi Pad	HP_1	6,5
	HP_13	4,0
	HP_11	6,0
	HP_12	6,5

Product	cod.	Net weight kg
Juli Plastic	JUP1 - JUP1M	11,0
	JUP3	6,0
	JUP4 - JUP4M	9,5
	JUP5H	10,0
	JUP5HR	11,0
	JUP6	5,7
	JUP7	6,0
	JUPX	0,5
Juli Soft	JUS1 - JUS1M	12,0
	JUS3	7,0
	JUS4 - JUS4M	10,5
	JUS5H	11,0
	JUS5HR	12,0
	JUS6	6,7
	JUS7	7,0
Lotus (Low)	LS_35	14,0
	LS_35CB	16,5
	LS_35CR	15,0
	LS_35CBR	17,5
Lotus (Medium)	LS_45	14,5
	LS_45CB	17,0
	LS_45CR	15,5
	LS_45CBR	18,0
Lotus (High)	LS_55	15,5
	LS_55CB	18,0
	LS_55CR	16,5
	LS_55CBR	19,0
Lud'ina	LUC3	13,5
	LUC5	14,0
	LUC5R	14,0
Morrison Stool	HP_13B	5,0
	HP_13BL	4,0
	HP_11B	6,5
	HP_11BL	5,5
	HP_12B	7,0
	HP_12BL	6,0
Newood	NW_1 - NW_1T	5,0
	CAR2	10,0
	NW_11 - NW_11T	5,5
	NW_12 - NW_12T	5,7
Newood Light	NWL1 - NWL1T	5,0
	CAR2	10,0
	NWL11 - NWL11T	5,5
	NWL12 - NWL12T	5,7
O-CAP	OCP5P	20,2
	OCP5RP	21,2
Peg Chair	PEG3R	11,0
Rainbow Chair	RC_1	14,5
Ribbon	RI_1LL	9,5
	RI_2LL	5,5
	RI_CU1	1,0
S-Chair	TD_1	12,5
	TD_1T	10,0
San Siro	MC_1 - MC_1R	11,0
San Siro Plus	MC_1 - MC_1R	11,0
Tate Color	TC_1	4,5
	TC_2	7,0

Weight Table

Product	cod.	Net weight kg
	TC_11	5,5
	TC_12	6,0
	TC_11B	10,0
	TC_12B	9,0
	TC_3	9,5
	TC_31	12,0
	TC_32	7,0
	TC_31B	10,0
	TC_32B	9,0
	TC_5H - TC_5HR	15,0
	CAR_1	10,0
Tate Soft	TS_1	6,5
	TS_2	8,0
	TS_11	7,0
	TS_12	8,0
	TS_11B	11,0
	TS_12B	10,0
	TS_3	10,0
	TS_31	13,0
	TS_32	8,0
	TS_31B	11,0
	TS_32B	10,0
	TS_5H - TS_5HR	16,0
	CAR_1	10,0
Tate Wood	TW_1	6,0
	TW_2	7,0
	TW_11	11,0
	TW_12	10,0
	TW_11B	10,0
	TW_12B	9,0
	TW_3	9,5
	TW_31	12,0
	TW_32	7,0
	TW_31B	10,0
	TW_32B	9,0
	TW_5H - TW_5HR	15,0
	CAR_1	10,0
BEDS		
Bed	NB_120	48,0
	NB_152	56,0
	NB_160	58,0
	NB_170	62,0
	NB_180	64,0
	NB_193	68,0
	NB_200	71,0
Fronzoni '64	FR_1	33,0
	FR_6	53,0
	FR_2	56,0
Peg Bed	PEG152	49,0
	PEG180	55,0
	PEG193	60,0
	PEG200	63,0
Superoblong bed	SB_100	83,0
	SB_152	94,0
	SB_170	100,0
	SB_180	104,0
	SB_193	110,0

Product	cod.	Net weight kg
COMPLEMENTARY		
Hangman	HG_1	11,0
	HG_2	14,0
Koeda	KOE 1	8,0
Mirror	MI_1	23,0
Poh	POH	140,0
Steel Pipe Drink Trolley	PC_21	14,0
Tuta	TU_1	9,0
PROGETTO OGGETTO		
Arya	PO_2002A	2,7
	PO_2002B	4,7
	PO_2002C	6,1
	PO_2003A	2,3
	PO_2003B	4,6
	PO_2003C	6,8
	PO_20052	12,0
	PO_20053	14,0
	PO_2004	20,0
	PO_2006C	17,0
	PO_2005C	20,0
Big Shadow	PO_9810 - PO_9811	2,0
	PO_9812	3,8
	PO_9815	2,9
Cord Lamp	PO_2103A	9,0
	PO_2103B	10,0
Meltdown	PO_1401	8,0
	PO_1402	21,0
	PO_1403	26,5
	PO_1301	4,0
	PO_1302	14,0
	PO_1303	30,0
3 Vases	PO_0803	7,2
Arya Vase	PO_2001A	1,5
	PO_2001B	3,6
	PO_2001C	4,2
Diavoletti Family	PO_1801	1,8
	PO_1802	1,6
	PO_1803	0,6
Glass Newson Vase	PO_9369V	3,0
	PO_9369T	4,0
Jana	PO_1409A	2,4
	PO_1409B	2,2
Monofiore	PO_9918	0,2
Newson Vase	PO_9369	1,2
Trace	PO_2101A	2,8
	PO_2101B	5,8
	PO_2101C	4,0
	PO_2101D	2,0
Cross	PO_9208B	6,8
Off The Moon	PO_1702	1,2
Blue Candle Holder	PO_1703	3,6
	PO_1704	4,0

FLEXI CONTAINER

Flexi Container

freestanding cases	317
hanging cases	319
case equipped with bar kit	320
case equipped with desk kit	320
extra back for bar kit	321
Glass case	321
open compartment / divider	322
shelves	323
drawers	324
leaf doors	326
upwards opening flap doors	327
upwards opening flap door push-pull opening	327
downward opening flap doors	328
metal bases	329
bases	331
feet / casters	331
closing top	332
handles	333
accessories and equipment	335
over back panels	339
wall panels	340
shelf for wall panels	340
cut-to-size	341

With Flexi Container the concept of design freedom through the systems becomes even more conspicuous, with a series of modular elements that can be combined in various and customized configurations. Flexi Container guarantees innumerable combinations of colours and finishes for all the components of the cabinets, as well as free combinations of doors, drawers and open compartments.



W. 60

W. 90

W. 120

Freestanding cases D. 43

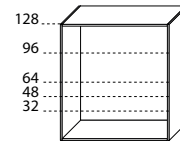
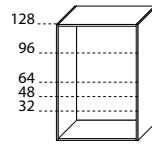
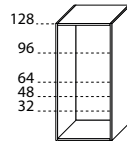

Freestanding cases D. 58

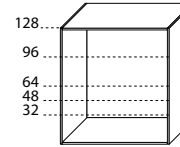
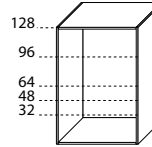
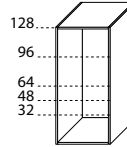

Wall-mounted cases D. 43

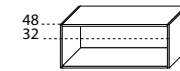
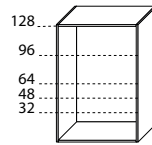
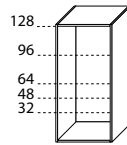

Bar kit cases D. 43

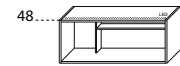
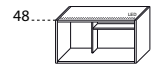

Desk kit cases D. 43

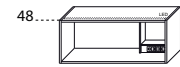
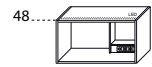

Extra backs for bar kit th. 0,5

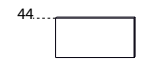

Open compartments for cases D. 43

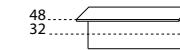
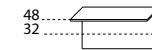
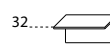

Dividers for open compartments D. 43

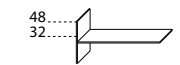
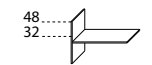

Glass cases for cases D. 43

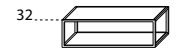

Wooden shelves D. 43



Wooden shelves D. 58



W. 30

W. 45

W. 60

W. 90

W. 120

Glass shelves D. 43



Glass shelves D. 58



Drawers - front th. 2 / D. 43

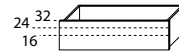
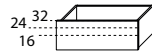
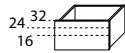

Drawers - front th. 2 / D. 58

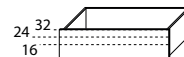
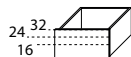

Leaf doors th. 2

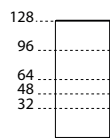
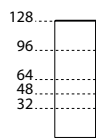
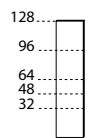

Upward flap doors th. 2

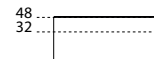
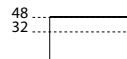

Downward flap doors th. 2

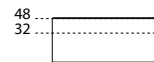
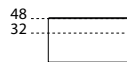

Wall panels th. 4

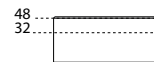
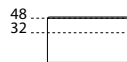
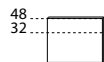

Shelves for wall panels - th. 1,2 / D. 28

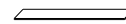
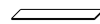

Over back panels th. 2

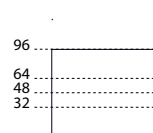
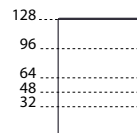
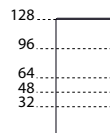

Closing top th. 1,2

depth
45-47-60-62

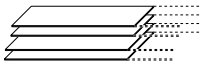

Closing top th. 2

depth
45-47-60-62



Closing top th. 4

depth
45-47-60-62

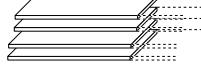

Marble top th. 2

depth
45



Shelves th. 4

depth
30



Shelves th. 8

depth
43-45-58-60

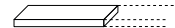

Corner fillers

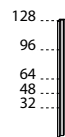

Vertical closing fillers

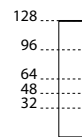

Metal bases D. 45

widths
60-90-120

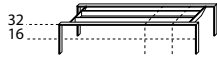

widths
180-210-240-270-300

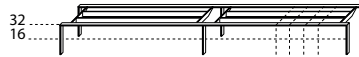

Metal bases D. 60

widths
60-90-120

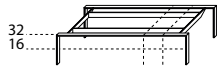

widths
180-210-240-270-300

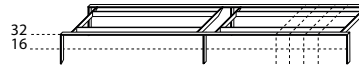

Bases D. 41

widths
90-105

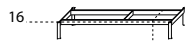

widths
150-180-210-240

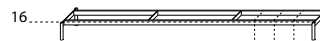

Cases

High-density wooden conglomerate panels thickness 2 cm.

Wall-mounted cases

Wall-mounted cases are equipped with two adjustable hooks for wall-fixing and spacers. If walls are crumbly, please use the set of chemical fixing.

Top

High-density wooden conglomerate panels thickness 1.2, 2 and 4 cm.

Colours and finishes

For all typologies of Flexi Container cases, the colour and the finish of the inside is always the same as the outside. However, free combinations of colours and finishes among the other elements of the collection (shelves, doors, drawers, tops, bases, handles, etc.) are available.

Inner drawers finish

Poplar plywood with melamine desert colour.

Handles

Metal, knob, push-pull latch.

ATTENTION:

Different handles can be mounted on the same container front. However, in case of push-pull latch, the front cannot be totally attached to the case, but must be detached some millimetres, for the magnetic system to work. For this reason, fronts with magnetic system are slightly misaligned with fronts with handles.

Feet

Grey plastic, height 2 cm
Metal base, height 16 cm and 32 cm
Grey plastic casters

Hinges

Leaf doors are equipped with hinges with integrated soft-close mechanism.

Caps

Caps for adjustments have the same colour as the cases.

Counterweight plates

Freestanding containers with drawers must be equipped with a counterweight plate only if used alone (not in composition with other containers). The counterweight plates are fixed on the outside of the back of the case. Containers on metal base depth 45 cm, starting from height 48 cm, must be equipped with a counterweight plate.

Support bars

Width 120 cm containers have a metal support bar, placed under the top and under the shelves. This bar is also available for width 90 cm containers (optional - see equipment). Support bars have matt lacquered finish, same colour as the container.

Drilling for shelves positioning

1- Shelf positioning within containers must follow the standard 32 cm pitch; for this reason, the standard drilling to refer to is shown in the following schemes. Should planning require it, custom drilling is anyway possible.

2- Inside containers with height 32 cm no shelves are foreseen. To place one, the positioning must be specified, by following the here-below scheme. In a container with height 48 cm flap door, the shelf is placed in the middle of the internal partition of the container.

Scheme for shelf positioning with h. 32 cm flap door

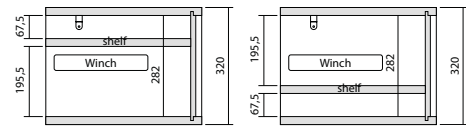

Example of standard positioning of an inner shelf for containers h. 48 and 64 cm

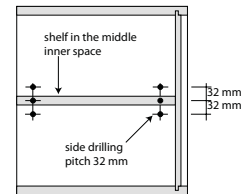

Example of standard positioning of an inner shelf for containers h. 96 and 128 cm

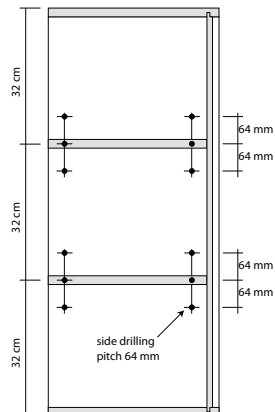

Continuous pitch 32 mm drilling is possible.

Arrangement for wall-fixing

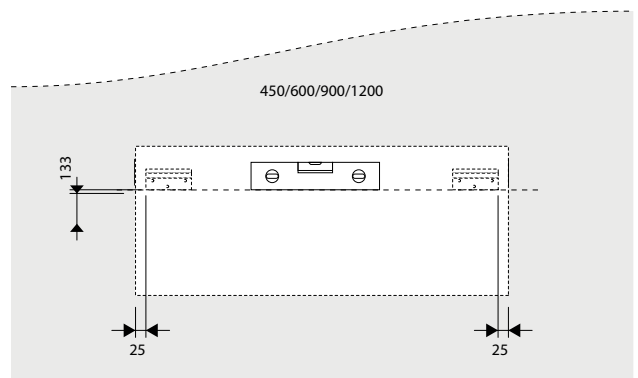

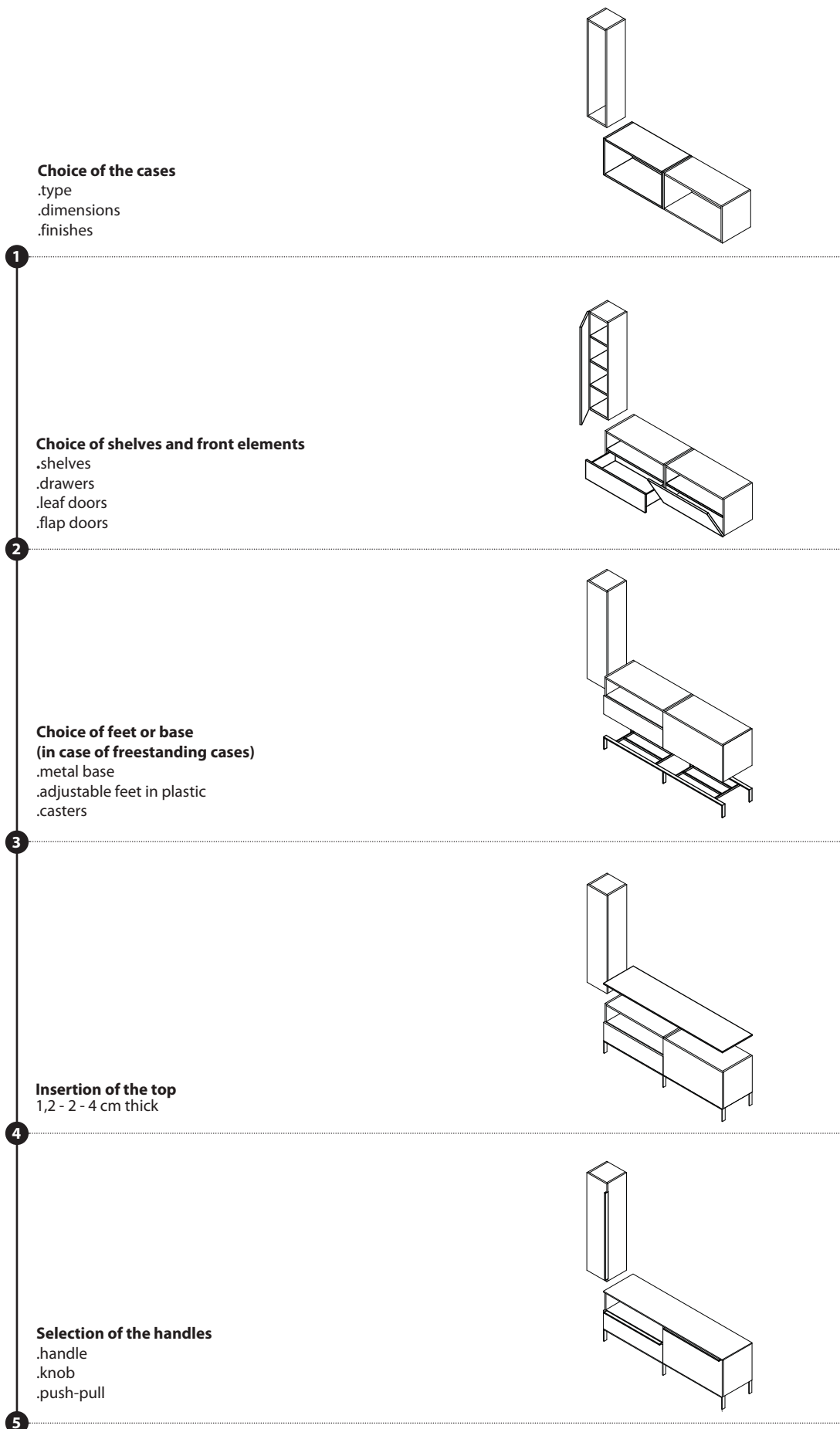

Elements typology

Finishes

CASES

- O** matt lacquer
- Z** matt lacquer extra
- L** polish lacquer
- Y** polish lacquer extra

SHELVES

- O** matt lacquer
- Z** matt lacquer extra
- L** polish lacquer
- Y** polish lacquer extra
- CR** transparent crystal

DRAWERS
DOORS

- O** matt lacquer
- Z** matt lacquer extra
- L** polish lacquer
- Y** polish lacquer extra

CLOSING TOPS

- O** matt lacquer
- Z** matt lacquer extra
- L** polish lacquer
- Y** polish lacquer extra
- Q** marble (only on upper top)

HANDLES

- 407** polish chrome
- O** matt lacquer
- Z** matt lacquer extra
- L** polish lacquer
- Y** polish lacquer extra

METAL BASES

- 407** polish chrome
- O** matt lacquer
- Z** matt lacquer extra

SHELVES

- O** matt lacquer
- Z** matt lacquer extra
- L** polish lacquer
- Y** polish lacquer extra
- R** oak

MATT / POLISH

- 01** white
- 46** magnolia
- 59** beige
- 60** desert
- 07** light grey
- 48** anthracite
- 04** black

MATT EXTRA / POLISH EXTRA



- 71** mud
- 93** straw yellow
- 78** pumpkin
- 45** chestnut brown
- 47** fog
- 10** dark grey
- 95** powder pink
- 96** terracotta
- 53** orange
- 94** brick red
- 55** red
- 54** bordeaux
- 84** aquamarine
- 81** jade
- 92** sage green
- 18** powder green
- 56** dark green
- 76** english green
- 77** petrol blue
- 91** sky blue
- 11** cloud
- 80** lapis
- 44** china blue
- 49** india blue



WOOD



- 133** natural oak
- 158** black-stained oak

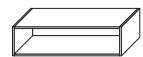

MARBLE

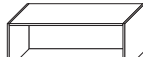

- 521** white carrara marble
- 528** grey roma marble

	W.60	W.90	W.120
			
Freestanding cases - H. 32	CSCS3Q	CSCN3Q	CSCV3Q
matt lacquer	815	990	1.300
matt lacquer extra	885	1.090	1.440
polish lacquer	1.395	1.780	2.305
polish lacquer extra	1.510	1.930	2.525

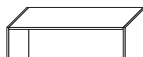

	W.60	W.90	W.120
			
Freestanding cases - H. 48	CSCS4Q	CSCN4Q	CSCV4Q
matt lacquer	885	1.095	1.440
matt lacquer extra	990	1.190	1.580
polish lacquer	1.615	2.035	2.625
polish lacquer extra	1.750	2.240	2.880

	W.60	W.90	W.120
			
Freestanding cases - H. 64	CSCS6Q	CSCN6Q	CSCV6Q
matt lacquer	1.010	1.210	1.500
matt lacquer extra	1.100	1.325	1.645
polish lacquer	1.845	2.315	2.880
polish lacquer extra	2.035	2.540	3.155

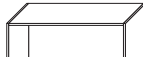

	W.60	W.90	W.120
			
Freestanding cases - H. 96	CSCS9Q	CSCN9Q	CSCV9Q
matt lacquer	1.265	1.455	1.895
matt lacquer extra	1.390	1.605	2.075
polish lacquer	2.375	2.885	3.640
polish lacquer extra	2.625	3.185	4.000

	W.60	W.90	W.120
			
Freestanding cases - H. 128	CSCS9Q	CSCN9Q	CSCV9Q
matt lacquer	1.440	1.740	2.110
matt lacquer extra	1.580	1.910	2.320
polish lacquer	2.815	3.485	4.245
polish lacquer extra	3.090	3.835	4.685

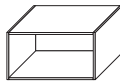
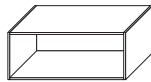

Cases must be equipped with adjustable feet or placed on metal bases. The height of the cases doesn't include feet/base. Single containers with drawers must be equipped with counterweight plate (see "overall features").

	W.60	W.90	W.120
			
Freestanding cases - H. 32	CSCS3S	CSCN3S	CSCV3S
matt lacquer	910	1.135	1.445
matt lacquer extra	1.010	1.250	1.585
polish lacquer	1.645	2.135	2.685
polish lacquer extra	1.805	2.325	2.965

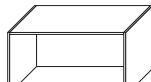

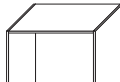
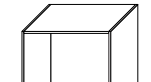
	W.60	W.90	W.120
			
Freestanding cases - H. 48	CSCS4S	CSCN4S	CSCV4S
matt lacquer	1.045	1.280	1.640
matt lacquer extra	1.135	1.395	1.800
polish lacquer	1.930	2.440	3.105
polish lacquer extra	2.135	2.680	3.425

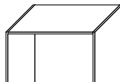
	W.60	W.90	W.120
			
Freestanding cases - H. 64	CSCS6S	CSCN6S	CSCV6S
matt lacquer	1.150	1.440	1.735
matt lacquer extra	1.280	1.580	1.910
polish lacquer	2.225	2.795	3.400
polish lacquer extra	2.435	3.070	3.755

	W.60	W.90	W.120
			
Freestanding cases - H. 96	CSCS9S	CSCN9S	CSCV9S
matt lacquer	1.430	1.700	2.155
matt lacquer extra	1.555	1.870	2.370
polish lacquer	2.795	3.450	4.265
polish lacquer extra	3.070	3.775	4.700

	W.60	W.90	W.120
			
Freestanding cases - H. 128	CSCSVS	CSCNVS	CSCVVS
matt lacquer	1.660	2.035	2.410
matt lacquer extra	1.815	2.245	2.655
polish lacquer	3.365	4.160	4.955
polish lacquer extra	3.680	4.570	5.440

Wall-mounted cases are equipped with two adjustable hooks for wall-fixing and spacers. In case of crumbly walls a set of chemical fixing can be used.

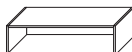
	W.60	W.90	W.120
			
Hanging cases - H. 32	CSPS3Q	CSPN3Q	CSPV3Q
matt lacquer	910	1.060	1.295
matt lacquer extra	1.010	1.160	1.435
polish lacquer	1.490	1.880	2.250
polish lacquer extra	1.635	2.060	2.470

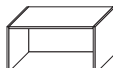
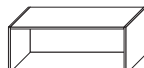
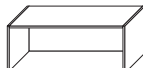
	W.60	W.90	W.120
			
Hanging cases - H. 48	CSPS4Q	CSPN4Q	CSPV4Q
matt lacquer	1.010	1.230	1.450
matt lacquer extra	1.110	1.345	1.605
polish lacquer	1.700	2.150	2.510
polish lacquer extra	1.870	2.370	2.760

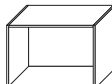
	W.60	W.90	
			
Hanging cases - H. 64	CSPS6Q	CSPN6Q	
matt lacquer	1.125	1.345	
matt lacquer extra	1.230	1.475	
polish lacquer	1.950	2.355	
polish lacquer extra	2.140	2.595	

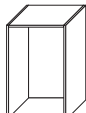
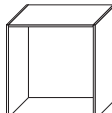
	W.60	W.90	
			
Hanging cases - H. 96	CSPS9Q	CSPN9Q	
matt lacquer	1.510	2.890	
matt lacquer extra	1.660	3.190	
polish lacquer	2.675	4.470	
polish lacquer extra	2.945	4.910	

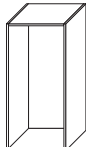
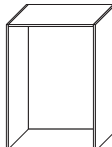
	W.60	W.90	
			
Hanging cases - H. 128	CSPSVQ	CSPNVQ	
matt lacquer	1.740	2.155	
matt lacquer extra	1.910	2.370	
polish lacquer	3.230	3.330	
polish lacquer extra	3.550	3.650	

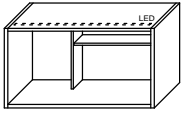

		matt lacquer	matt lacquer extra	polish lacquer	polish lacquer extra
KCBN4Q	Bar kit 90X43X48	2.540	2.635	3.290	3.400

The bar kit includes:
 - led light;
 - partition element

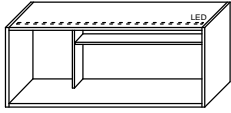

		matt lacquer	matt lacquer extra	polish lacquer	polish lacquer extra
KCBV4Q	Bar kit 120x43x48	2.900	3.035	3.865	4.000

The bar kit includes:
 - led light;
 - partition element

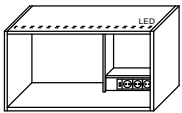

		matt lacquer	matt lacquer extra	polish lacquer	polish lacquer extra
KCPN4Q	Desk kit 90X43X48	3.740	3.830	4.490	4.615

The desk kit includes:
 - Led light;
 - Partition element;
 - Electric sockets

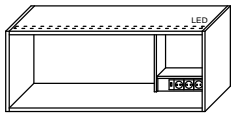

		matt lacquer	matt lacquer extra	polish lacquer	polish lacquer extra
KCPV4Q	Kit Desk 120x43x48	3.980	4.080	4.900	5.045

The desk kit includes:
 - Led light;
 - Partition element;
 - Electric sockets

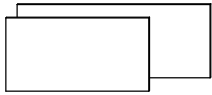

		Crystal
KCSN4Q	Back for bar kit W. 86	250
KCSV4Q	Back for bar kit W. 116	315

Flexi Container - Glass case

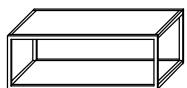

		matt lacquer	matt lacquer extra	polish lacquer	polish lacquer extra
VGEN4TO	glass case matt lacquered structure 90x45x32	1.100	1.110	1.435	1.495
VGEV4TO	glass case matt lacquered structure 120x45x32	1.410	1.430	1.835	1.910
VGEN4TZ	glass case extra matt lacquered structure 90x45x32	1.150	1.160	1.495	1.580
VGEV4TZ	glass case extra matt lacquered structure 120x45x32	1.475	1.490	1.920	2.010

- 1. upper/lower wooden panels
- 2. metal structure
- 3. glass panels
- 4. open compartment

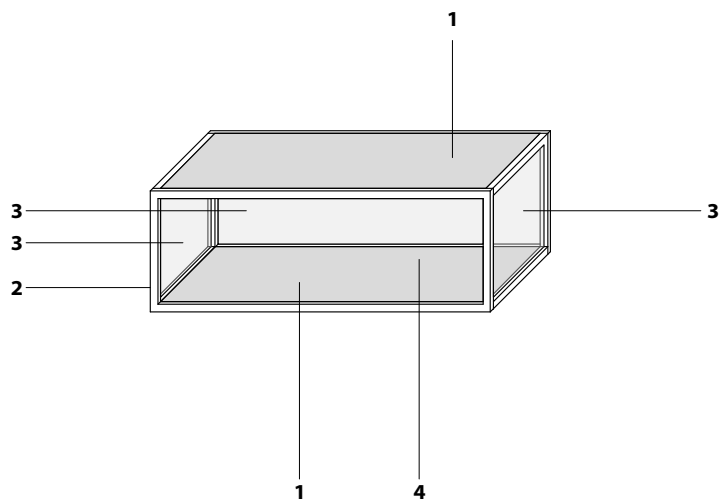

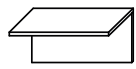

		matt lacquer	matt lacquer extra	polish lacquer	polish lacquer extra
CSLS4T	open compartment 60x41x32	225	230	250	265

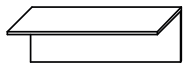

		matt lacquer	matt lacquer extra	polish lacquer	polish lacquer extra
CSLN4T	open compartment 90x41x32	295	300	315	335

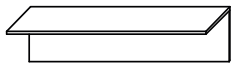

		matt lacquer	matt lacquer extra	polish lacquer	polish lacquer extra
CSLV4T	open compartment 120x41x32	360	390	400	415

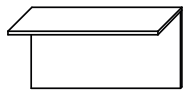

		matt lacquer	matt lacquer extra	polish lacquer	polish lacquer extra
CSLN4Q	open compartment 90x41x48	305	330	340	355

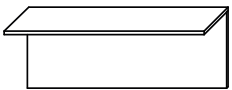

		matt lacquer	matt lacquer extra	polish lacquer	polish lacquer extra
CSLV4Q	open compartment 120x41x48	400	415	420	435

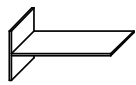

		matt lacquer	matt lacquer extra	polish lacquer	polish lacquer extra
CSDN4T	divider 60x39x32	295	300	315	335

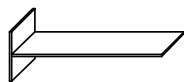

		matt lacquer	matt lacquer extra	polish lacquer	polish lacquer extra
CSDV4T	divider 90x39x32	360	390	400	415

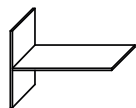

		matt lacquer	matt lacquer extra	polish lacquer	polish lacquer extra
CSDN4Q	divider 60x39x48	305	330	340	355

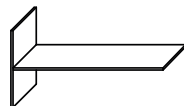

		matt lacquer	matt lacquer extra	polish lacquer	polish lacquer extra
CSDV4Q	divider 90x39x48	400	415	420	435

The standard drilling for the shelves is illustrated in the general notes and follows the standard 32 cm pitch. In case of extra shelves the drilling becomes continuous with pitch 32 mm.

H. 2 - Wooden shelf for partitions 60 cm



		matt lacquer	matt lacquer extra	polish lacquer	polish lacquer extra
RLS045	W. 56 - D. 43	210	215	285	305
RLS060	W. 56 - D. 58	245	255	360	410

H. 2 - Wooden shelf for partitions 90 cm

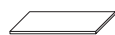

		matt lacquer	matt lacquer extra	polish lacquer	polish lacquer extra
RLN045	W. 86 - D. 43	250	285	420	445
RLN060	W. 86 - D. 58	320	355	525	560

H. 2 - Wooden shelf for partitions 120 cm

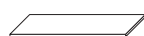

		matt lacquer	matt lacquer extra	polish lacquer	polish lacquer extra
RLV045	W. 116 - D. 43	420	450	640	700
RLV060	W. 116 - D. 58	525	570	880	950

H. 0,8 - Transparent glass shelf for partitions 60 cm



			CR transp. glass
RVS045	W. 56 - D. 43		155
RVS060	W. 56 - D. 58		210

H. 0,8 - Transparent glass shelf for partitions 90 cm



			CR transp. glass
RVN045	W. 86 - D. 43		215
RVN060	W. 86 - D. 58		275

H. 0,8 - Transparent glass shelf for partitions 120 cm



			CR transp. glass
RVV045	W. 116 - D. 43		265

Reductions are not possible. The structure of drawers is always in melamine desert. Freestanding containers from height 32 cm with drawers must be equipped with a counterweight plate only if used alone (not in composition with other containers).

Each drawer must be equipped with handle or push-pull mechanism.

For fronts 120 cm wide, a double handle is needed in case of model L. 15 cm., embedded handle, or knob.

H.16 Leaf drawers - D. 43
working height 10 cm

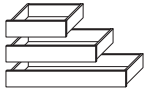

		matt lacquer	matt lacquer extra	polish lacquer	polish lacquer extra
1CS016	width 60	330	360	415	445
1CN016	width 90	360	410	475	525
1CV016	width 120	430	465	560	610

H. 24 Leaf drawers - D.43
working height 15 cm

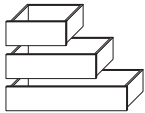

		matt lacquer	matt lacquer extra	polish lacquer	polish lacquer extra
1CS024	width 60	360	410	475	525
1CN024	width 90	420	445	560	610
1CV024	width 120	485	525	680	730

H. 32 Drawers - D.43
working height 24 cm

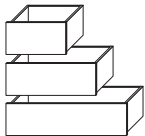

		matt lacquer	matt lacquer extra	polish lacquer	polish lacquer extra
1CS032	width 60	440	485	560	610
1CN032	width 90	525	560	705	765
1CV032	width 120	590	660	655	865

Counterweight plates for containers with drawers/doors

		Price
PIA002	for containers width 60	130
PIA003	for containers width 90/120	145

Reductions are not possible. The structure of drawers is always in melamine desert. Freestanding containers from height 32 cm with drawers must be equipped with a counterweight plate only if used alone (not in composition with other containers).

Each drawer must be equipped with handle or push-pull mechanism.

For fronts 120 cm wide, a double handle is needed in case of model L. 15 cm., embedded handle, or knob.

H. 16 Leaf drawers - D.58 working height 10 cm

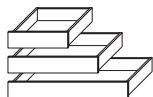

		matt lacquer	matt lacquer extra	polish lacquer	polish lacquer extra
1KS016	width 60	375	410	445	495
1KN016	width 90	420	445	540	580
1KV016	width 120	475	525	640	700

H. 24 Leaf drawers - D.58 working height 15 cm

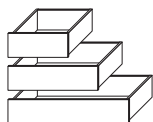

		matt lacquer	matt lacquer extra	polish lacquer	polish lacquer extra
1KS024	width 60	400	430	540	580
1KN024	width 90	475	525	645	705
1KV024	width 120	540	585	755	830

H. 32 Drawers - D. 58 working height 24 cm

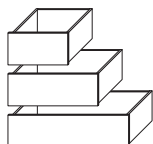

		matt lacquer	matt lacquer extra	polish lacquer	polish lacquer extra
1KS032	width 60	495	550	645	705
1KN032	width 90	580	645	790	850
1KV032	width 120	645	705	790	850

Counterweight plates for containers with drawers/doors

		Price
PIA002	for containers width 60	130
PIA003	for containers width 90/120	145

Leaf doors have 90° opening hinges and integrated soft-close mechanism.
180° opening hinges are available on request and without extra charges.
Leaf door must be equipped with handle or push-pull mechanism.

Leaf doors - H. 32 - thickness 2



		matt lacquer	matt lacquer extra	polish lacquer	polish lacquer extra
BLT032	W.30	155	185	225	250
BLQ032	W.45	210	225	295	315
BLS032	W.60	245	265	355	410

Leaf doors - H. 48 - thickness 2



		matt lacquer	matt lacquer extra	polish lacquer	polish lacquer extra
BLT048	W.30	210	225	295	315
BLQ048	W.45	230	250	355	400
BLS048	W.60	250	275	475	525

Leaf doors - H. 64 - thickness 2



		matt lacquer	matt lacquer extra	polish lacquer	polish lacquer extra
BLT064	W.30	225	245	330	375
BLQ064	W.45	275	300	435	480
BLS064	W.60	300	325	495	555

Leaf doors - H. 96 - thickness 2

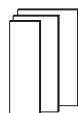

		matt lacquer	matt lacquer extra	polish lacquer	polish lacquer extra
BLT096	W.30	285	305	440	490
BLQ096	W.45	330	375	570	640
BLS096	W.60	390	420	675	735

Leaf doors - H. 128 - thickness 2



		matt lacquer	matt lacquer extra	polish lacquer	polish lacquer extra
BLT128	W.30	355	410	570	640
BLQ128	W.45	435	475	755	805
BLS128	W.60	495	550	905	1.005

Upwards opening flap doors can be used on cases 43 cm deep. For fronts 120 cm wide, a double handle is needed in case of model 15 cm or knob.

Upwards opening flap doors - H. 32 - th. 2

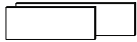

		matt lacquer	matt lacquer extra	polish lacquer	polish lacquer extra
RSN032	W.90	505	555	655	705
RSV032	W.120	565	645	765	830

Upwards opening flap doors - H. 48 - th. 2

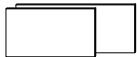

		matt lacquer	matt lacquer extra	polish lacquer	polish lacquer extra
RSN048	W.90	580	650	790	865
RSV048	W.120	660	725	925	1.010

Flexi Container - upwards opening flap door push-pull opening

Upwards opening flap doors can be used on cases 43 cm deep. Push-pull mechanism is included in the price of the door.

Upwards opening flap doors push-pull opening - H. 32 - th. 2

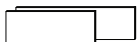

		matt lacquer	matt lacquer extra	polish lacquer	polish lacquer extra
RCN032	W.90	605	650	765	790
RCV032	W.120	665	705	865	925

Upwards opening flap doors push-pull opening - H. 48 - th. 2



		matt lacquer	matt lacquer extra	polish lacquer	polish lacquer extra
RCN048	W.90	695	730	920	950
RCV048	W.120	770	825	1.045	1.100

Downward opening doors can be used on cases depth 43 cm reduced in depth till 33 cm.



Downward opening th. 2 cm - with Winch mechanism

The doors can be hinged only on the lower part.

Flap doors: cut-to size available on width only:

- for height 32 cm minimum width 70 cm
- for height 48 cm minimum width 60 cm

Handle for flap door th. 2 cm - W. 90 cm - H. 32/48 cm

Flap doors width 90 cm can be equipped with:

- 1 - Milled handle M05 front edge: all measures, single or double
- 2 - Push-pull

Handle for flap door th. 2 cm - W. 120 cm - H. 32/48 cm

Flap doors width 120 cm can be equipped with:

- 1 - Milled handle M05 front edge: only M05084 or M05114 central, or M05015 double
- 2 - Push-pull

Downward opening flap doors - H. 32 - th. 2



		matt lacquer	matt lacquer extra	polish lacquer	polish lacquer extra
ARN032	W.90	555	605	710	780
ARV032	W.120	640	695	835	905

Downward opening flap doors - H. 48 - th. 2



		matt lacquer	matt lacquer extra	polish lacquer	polish lacquer extra
ARN048	W.90	645	705	850	940
ARV048	W.120	725	795	1.010	1.100

Bases larger than W. 180 are provided with a central foot.

Cuts-to-size are not possible.

Metal bases - available lengths according to the height of the cases:

- length 180 cases max. height 160
- length 210 cases max. height 160
- length 240 cases max. height 128
- length 270-300 cases max. height 96

D. 45 Metal bases for cases - H. 16

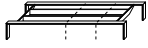

		matt lacquer	matt lacquer extra	407 chromed
BAQ060	width 60	1.275	1.415	1.835
BAQ090	width 90	1.490	1.630	2.040
BAQ120	width 120	1.690	1.835	2.530

D. 45 Metal bases for cases - H. 16



		matt lacquer	matt lacquer extra	407 chromed
BAQ180	width 180	2.260	2.395	3.100
BAQ210	width 210	2.675	2.815	3.515
BAQ240	width 240	3.240	3.380	4.220
BAQ270	width 270	3.515	3.655	4.505
BAQ300	width 300	3.795	3.940	4.920

D. 60 Metal bases for cases - H. 16

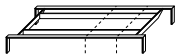

		matt lacquer	matt lacquer extra	407 chromed
BAS060	width 60	1.200	1.335	1.545
BAS090	width 90	1.435	1.575	1.790
BAS120	width 120	1.580	1.715	1.930

D. 60 Metal bases for cases - H. 16



		matt lacquer	matt lacquer extra	407 chromed
BAS180	width 180	2.060	2.200	2.420
BAS210	width 210	2.585	2.715	2.935
BAS240	width 240	2.815	2.965	3.165
BAS270	width 270	3.085	3.225	3.430
BAS300	width 300	3.270	3.410	3.620

Bases larger than W. 180 are provided with a central foot.

Cuts-to-size are not possible.

Metal bases - available lengths according to the height of the cases:

- length 150-240 cases max. height 96

D. 45 Metal bases for cases - H. 32



		matt lacquer	matt lacquer extra	407 chromed
BTQ060	width 60	1.345	1.545	1.395
BTQ090	width 90	1.630	1.805	1.615
BTQ120	width 120	1.660	1.835	2.320

D. 45 Metal bases for cases - H. 32



		matt lacquer	matt lacquer extra	407 chromed
BTQ180	width 180	2.285	2.505	2.350
BTQ210	width 210	2.675	2.940	2.760
BTQ240	width 240	2.860	3.280	2.985

D. 60 Metal bases for cases - H. 32

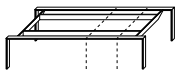

		matt lacquer	matt lacquer extra	407 chromed
BTS060	width 60	1.335	1.455	1.390
BTS090	width 90	1.605	1.750	1.645
BTS120	width 120	1.695	1.855	1.740

D. 60 Metal bases for cases - H. 32



		matt lacquer	matt lacquer extra	407 chromed
BTS180	width 180	2.305	2.525	2.380
BTS210	width 210	2.890	3.190	3.165
BTS240	width 240	3.185	3.490	3.390

Bases to use for compositions like EASY (Container and bookcase), available in matt black.
 For compositions height till 68 cm, the base is 30 cm smaller in width than the composition, on each side; for compositions height more than 68 cm, the base is 15 cm smaller in width than the composition, on each side.
 It is necessary to use the lower top that has to be placed on the base, so to add in a second moment the cases.

D. 41 Metal bases for cases - H. 16

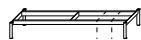

		Price
BEQ090	width 90	605
BEQ105	width 105	640
BEQ150	width 150	785
BEQ180	width 180	810
BEQ210	width 210	895
BEQ240	width 240	1.090

Flexi Container - feet / casters



		Price
CS_16	H. 2-4 Set of 4 adjustable feet in plastic	80



		Price
CS_12	H. 7 Caster in grey plastic (with plate)	75

Closing tops depth cm. 47 and cm. 62 are needed in case of over back panels for cases placed in the middle of the room.

TH. 1,2 - Closing top

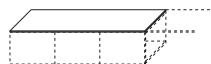

		matt lacquer	matt lacquer extra	polish lacquer	polish lacquer extra
CST451	depth 45 per lmt.	410	435	660	725
CST471	depth 47 per lmt.	420	445	695	755
CST601	depth 60 per lmt.	490	550	835	910
CST621	depth 62 per lmt.	525	560	865	945

TH. 2 - Closing top

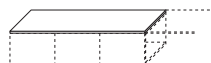

		matt lacquer	matt lacquer extra	polish lacquer	polish lacquer extra
CST452	depth 45 per lmt.	430	465	680	735
CST472	depth 47 per lmt.	435	485	700	760
CST602	depth 60 per lmt.	505	555	845	925
CST622	depth 62 per lmt.	535	580	880	985

TH. 2 - Closing top for Easy

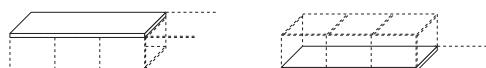

		matt lacquer	matt lacquer extra	polish lacquer	polish lacquer extra	Marble
CST45E	depth 45 - closing top	430	465	680	735	1.525
CSB45E	depth 45 - lower top	430	465	680	735	

TH. 4 - Closing top

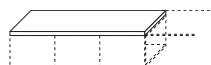

		matt lacquer	matt lacquer extra	polish lacquer	polish lacquer extra
CST454	depth 45 per lmt.	490	550	805	880
CST474	depth 47 per lmt.	505	560	835	910
CST604	depth 60 per lmt.	590	675	1.010	1.100
CST624	depth 62 per lmt.	640	700	1.050	1.135



P21

polish chromed

diameter 1,5 cm
depth 3 cm

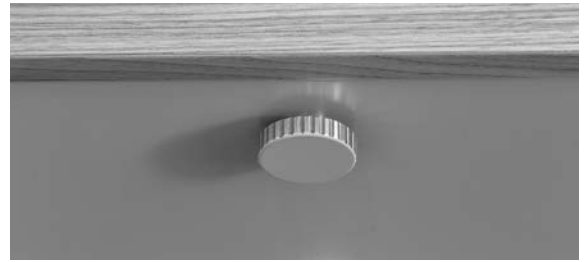

p22

matt lacquer
matt lacquer extra



M05

Embedded handle fixed without glues or screws

polish chromed
matt lacquer
matt lacquer extra
polish lacquer
polish lacquer extra

M05015	length 15 cm
M05024	length 24 cm
M05039	length 39 cm
M05054	length 54 cm
M05084	length 84 cm
M05114	length 114 cm
M05174	length 174 cm

P21 - Knob - polished chrome



		407 chromed
P21	Knob - polished chrome	50



		matt lacquer	matt lacquer extra
P22	Knob	90	100

M05 - Handle- lacquered/polished chrome

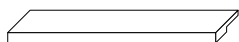

		matt lacquer	matt lacquer extra	polish lacquer	polish lacquer extra	407 chromed
M05015	width 15	140	145	150	155	140
M05024	width 24	150	155	160	165	155
M05039	width 39	160	165	170	185	165
M05054	width 54	185	190	195	200	190
M05084	width 84	225	230	240	245	230
M05114	width 114	250	255	265	270	255
M05174	width 174	360	370	390	410	370

Push-pull and locks

		Price
CRC	Pair of push-pull mechanisms for drawer	70
CRA	Push-pull mechanisms for leaf door	70
CRP	Pair of push-pull mechanisms for flap doors (for door width 90 and 120)	70
SA	Lock for door	80
SC_	Lock for drawer	80

Handles are positioned on doors and drawers as per schemes below. When positioning is customized, specifications must be supplied with accurate drawings and measures. In any case, production considers the feasibility of personalization. Increase is not foreseen for customized handles position.

Standard position of knob and handles (excluded handles with code M05015 - M05024- M05039- M05054 - M05084 - M05114-M05174) on drawers fronts or doors is:

1. central position: handle centre line 4 cm from upper or lower edge centre line of front
2. central position: horizontal and vertical centre line of front for drawers and doors with maximum dimensions 60xh.64 cm (position 6)
3. position opposed to the hinge: handle centre line 4 cm from upper or lower edge and 3 cm from vertical edge

Knob

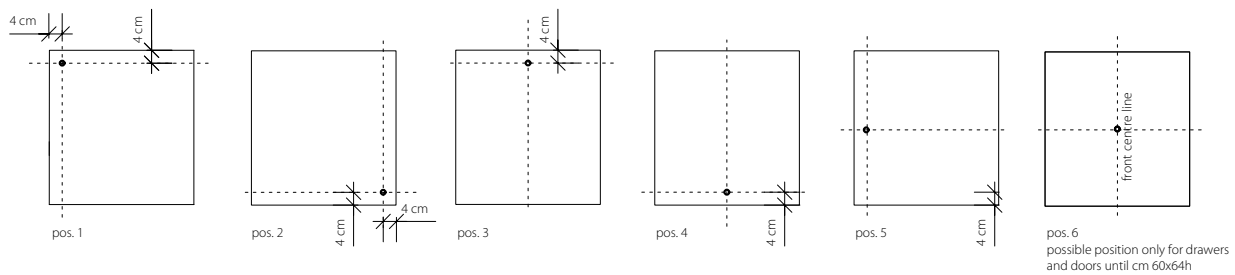

single handle - horizontal position

example with handle M05015

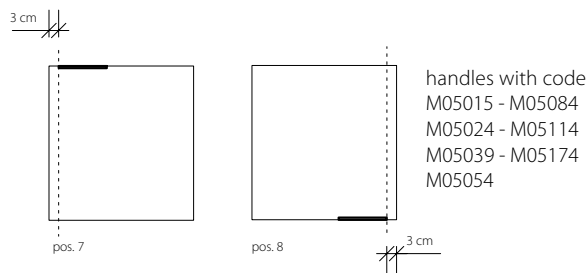

double handle- only horizontal position

example with handle M05015

(available only on drawers W. 90 and 120 cm)

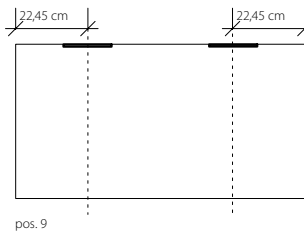

single handle - vertical position

example with handle M05015

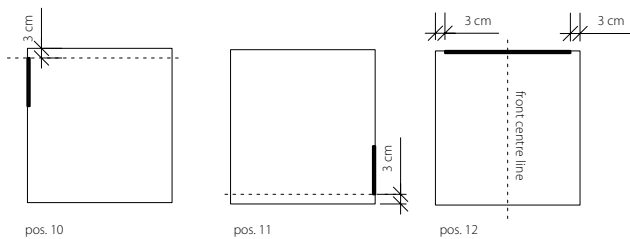

single handle - central, horizontal and vertical position - M05039

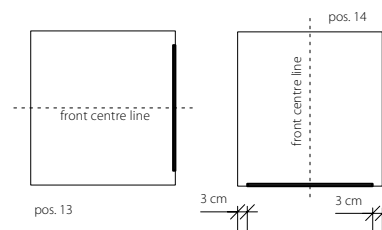

5x5 Corner fillers - thickness 2

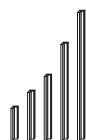

		matt lacquer	matt lacquer extra	polish lacquer	polish lacquer extra
FA5032	height 32	85	85	105	110
FA5048	height 48	95	105	145	145
FA5064	height 64	110	125	155	195
FA5096	height 96	145	145	230	250
FA5128	height 128	155	185	285	305

W. 5-30 Vertical closing fillers - thickness 2



		matt lacquer	matt lacquer extra	polish lacquer	polish lacquer extra
FTA032	height 32	80	80	110	125
FTA048	height 48	85	95	145	145
FTA064	height 64	105	105	185	200
FTA096	height 96	130	140	245	265
FTA128	height 128	150	185	305	340

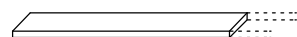

		matt lacquer	matt lacquer extra	polish lacquer	polish lacquer extra	wood
MMT	D. 30 Wall wooden shelf 4 th. (lmt) - with shelf supporting - depth 30	375	410	475	525	380

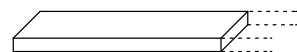

		matt lacquer	matt lacquer extra	polish lacquer	polish lacquer extra	wood
MMQ7	Wall shelf 8 cm th. D. 43	755	790	955	1.020	790
MMQ8	Wall shelf 8 cm th. D. 45	720	760	1.005	1.065	825
MMS7	Wall shelf 8 cm th. D. 58	920	955	1.190	1.235	955
MMS8	Wall shelf 8 cm th. D. 60	940	920	1.225	1.290	920

Maximum lenght lacquered shelves: 3,6 mt
Maximum lenght veneered shelves: 3 mt

						Price
SAC	Set of chemical fixing					165

H. 68 Supporting end upright for special projects - thickness 4

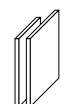

		matt lacquer	matt lacquer extra	polish lacquer	polish lacquer extra	wood
SLQ068	depth 45	255	275	490	540	340
SLS068	depth 60	315	340	610	695	435

H. 15 Band as undertop bar - thickness 2

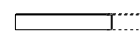

		matt lacquer	matt lacquer extra	polish lacquer	polish lacquer extra
FCA152	per lmt.	125	130	225	245

Inner extractable file holder

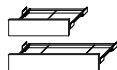

		N melamine desert
CAC015	Inner extractable file holder depth 38 cm. - width 60 cm. (only for leaf door)	255
CAC016	Inner extractable file holder depth 38 cm. - width 90 cm. (only for leaf door)	320

Extractable file holder equipped with front - H. 32

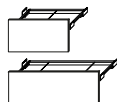

		matt lacquer	matt lacquer extra	polish lacquer	polish lacquer extra
CAC026	width 60	365	370	445	455
CAC027	width 90	455	465	580	585

Extractable file holder equipped with front - H. 48

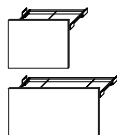

		matt lacquer	matt lacquer extra	polish lacquer	polish lacquer extra
CAC029	width 60	415	425	550	565
CAC030	width 90	540	560	710	725

Supporting bar for container width 90 to be placed under top and shelves

		Price
BS_90	width 90	105

Supporting bars have matt lacquer finish, same colour as the container.

Clothes hanger bars available for Flexi and Container, as well

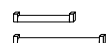

		Price
CAC003	Clothes hanger bar - width 60	60
CAC004	Clothes hanger bar - width 90	70



		Price
AE_45	Extractable clothes hanger for D. 45	85



		Price
GH9SC	Fairlead ring for backrests th. 1,2 cm. Ø 9,2 - chromed aluminium - with swivel cap	280



		Price
GH9SP	Fairlead ring for elements th. 2 cm. Ø 9,2 - chromed aluminium - with swivel cap	250



		Price
GH9T	Fairlead ring for elements th. 3,2 cm. Ø 9,2 - chromed aluminium - with swivel cap and fairlead	260



		Price
GHI1	Fairlead ring 7,5x7,5 cm.	125

		Price
LED1	Led light for 60 cm wide cases	555
LED2	Led light for 90 cm wide cases	615
LED3	Led light for 120 cm wide cases	670

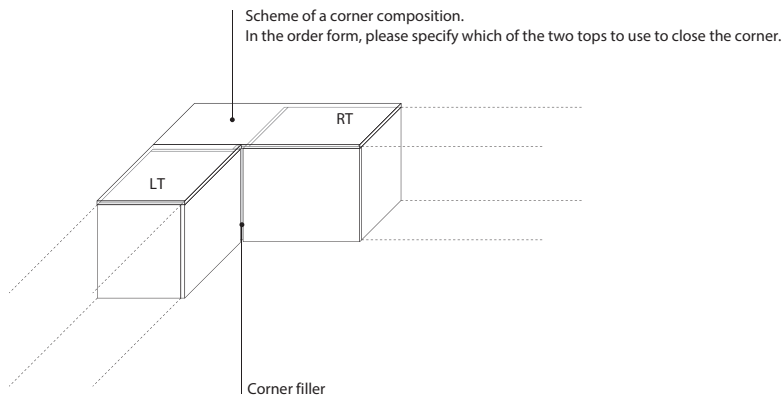

Example of how to use a top th. 4 cm "covering" two freestanding cases (depth 45 and 60 cm). Maximum distance between the case is 120 cm with exception for custom projects.

To have the top at height 72, cases must be equipped with 4 cm high adjustable feet. Cases can have different width from one another.

To support the pass-through top, it is essential to put a band to be used as a bar.

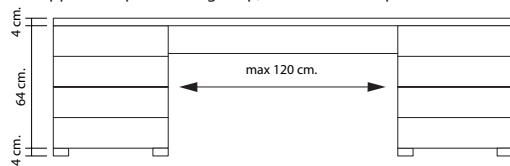

Example of how to use a top thickness 4 cm "covering" a freestanding case and an end side (depth 45 and 60 cm). Maximum distance between the cases is 120 cm with exception for custom projects.

To have the top at height 72, cases must be equipped with 4 cm high wooden adjustable feet.

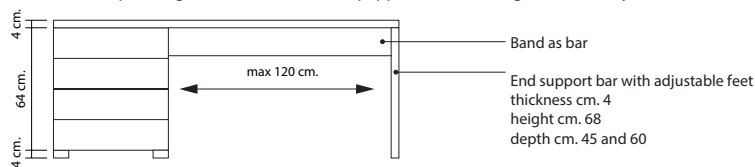

With over back panels tops depth 47 and 62 cm are needed.

W. 60 Over back panels for double-face use - thickness 2



		matt lacquer	matt lacquer extra	polish lacquer	polish lacquer extra
CZS032	height 32	255	280	390	435
CZS048	height 48	305	325	480	545
CZS064	height 64	355	390	600	650
CZS096	height 96	445	480	810	885
CZS128	height 128	545	590	1.005	1.105

W. 90 Over back panels for double-face use - thickness 2

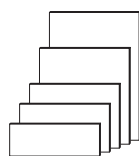

		matt lacquer	matt lacquer extra	polish lacquer	polish lacquer extra
CZN032	height 32	305	325	480	545
CZN048	height 48	370	410	650	705
CZN064	height 64	445	480	810	885
CZN096	height 96	590	640	1.110	1.220
CZN128	height 128	725	795	1.435	1.570

W. 120 Over back panels for double-face use - thickness 2

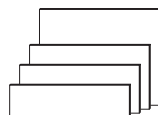

		matt lacquer	matt lacquer extra	polish lacquer	polish lacquer extra
CZV032	height 32	410	445	725	810
CZV048	height 48	510	560	985	1.095
CZV064	height 64	640	705	1.260	1.395
CZV096	height 96	895	985	1.810	1.985

wall panel H. 32 - th. 4

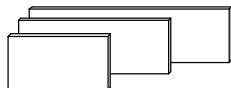

		matt lacquer	matt lacquer extra	polish lacquer	polish lacquer extra
PPT060	W. 60	390	410	490	505
PPT090	W. 90	530	555	670	700
PPT120	W. 120	660	680	835	890

wall panel H. 48 - th. 4

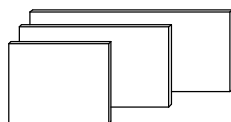

		matt lacquer	matt lacquer extra	polish lacquer	polish lacquer extra
PPQ060	W. 60	560	570	720	735
PPQ090	W. 90	680	725	890	920
PPQ120	W. 120	835	890	1.090	1.130

Flexi Container - shelf for wall panels

shelf for wall panels - th. 1,2

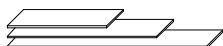

		matt lacquer	matt lacquer extra	polish lacquer	polish lacquer extra
MBT060	W. 60	240	270	295	310
MBT090	W. 90	310	325	385	420
MBT120	W. 120	440	465	555	565

Cut-to size reductions on drawers are not possible.

Price increase for case cut-to size: + 20%

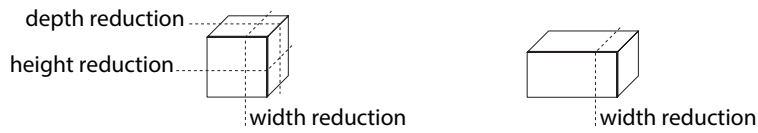

COS2

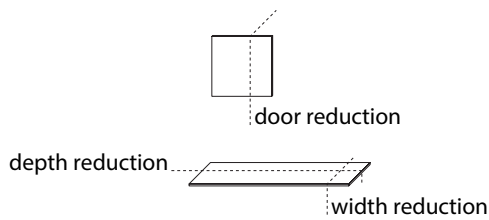

	Price
COT1	110

Leaf doors: no limitation for cut to size reduction

Flap doors: cut-to size available on width only:
for height 32 minimum width cm. 70
for height 48 minimum width cm. 60

Cut without fairlead ring – profile finished with aluminium band

	Price
SCA	80

