

HAWORTH

Openest Collection

GSA Price List – March 2024



This price list is based upon Haworth's February 2024 commercial pricing.
GENERAL SERVICES ADMINISTRATION FEDERAL SUPPLY SERVICE
Authorized Federal Supply Scheduled Price List (Catalog) Office Furniture, Wood Casegoods and Tables
(FSC Group 71, Part I, FSC Classes 7105, 7110, 7125 and 7195)
Contract No: GS-03F-057DA | Contract Period: February 8, 2016 – February 7, 2026 | Business: Large
Contractor: Haworth, Inc. | One Haworth Center | Holland, MI 49423-9576 | 1.616.393.3000





This Haworth North American price book contains US list prices.

Canadian customers can convert the US list price into their Canadian equivalent by going to www.Haworth.com/Canada to find the current Canadian multipliers. These multiplier factors allow you to convert the US list price into a Canadian list price.

HAWORTH, INC.
GENERAL SERVICES ADMINISTRATION
FEDERAL ACQUISITION SERVICES

Authorized Federal Supply Schedule
Furniture
(FSC Group 71, FSC Classes 7105, 7110, 7125 and 7195)

Contract Number: GS-03F-057DA
Contract Start Date: February 8, 2016
Contract End Date: February 7, 2026
Contractor: HAWORTH, INC.
One Haworth Center
Holland, MI 49423-9576
1-616-393-3000
<http://www.haworth.com/government>
Business Size: Large

Information for Ordering Activities
I-FSS-600

Online access to Haworth's Authorized Federal Supply Schedule contract ordering information, terms and conditions, and up-to-date product and discount listing can be found at GSA Advantage, eLibrary link [here](#).

Table of Contents

At-A-Glance	5
Statement of Line	6-7
Plume Screens	
Plume 3	8
Plume 6	8
Plume 9	8
Feather Sofa	
Feather – Symmetrical	9
Feather – Asymmetrical	9
Chick Pouf	
Chick Pouf with Back	10
Chick Pouf without Back	10
Large Square - No Back	11
Rectangle - No Back	11
Round - No Back	12
Sprig Tables	
Rectangle	13
Round	13
Desk	
Single Desk	14
Double Desk	15
Privacy Desk	16
Booth	
Single Booth	17
Double Booth	18
Corner Booth	19
Privacy Booth	20
Conference Booth	21
Height Adjustable Table	22
Accessories	
Coat Hook	23
Soft Storage	23
Pillows	23
Hideaway Power Module	24
Bezel Utility Module	25
Finishes and Fabrics	
Finish/Color Legend	26
Fabrics/Color Legends	27
Index	28
Lifetime Product Warranty	Inside Back Cover

At-A-Glance

Designer Patricia Urquiola - Studio Urquiola

Awards/Achievements NeoCon 2014 - Best of Competition - Collaborative Collections
NeoCon 2014 - Best of NeoCon Gold - Collaborative Collections

Plume Screen

- Available:
 - Plume 3 - (1) screen 57"H, (1) screen 65"H, (1) screen 61"H
 - Plume 6 - (6) screens all 57"H (shown)
 - Plume 9 - (9) screens all 57"H
- Screens always connect

Feather Sofa

- Available: Symmetrical or Asymmetrical (Left Handed Asymmetrical shown)
- With or without attached table
- Specifiable top stitch
- Fabric always applied railroad

Chick Pouf without Back
• Specifiable top stitch

Chick Pouf with Back
• Seat and Inside Back always match
• Base and Backrest always match
• Specifiable top stitch

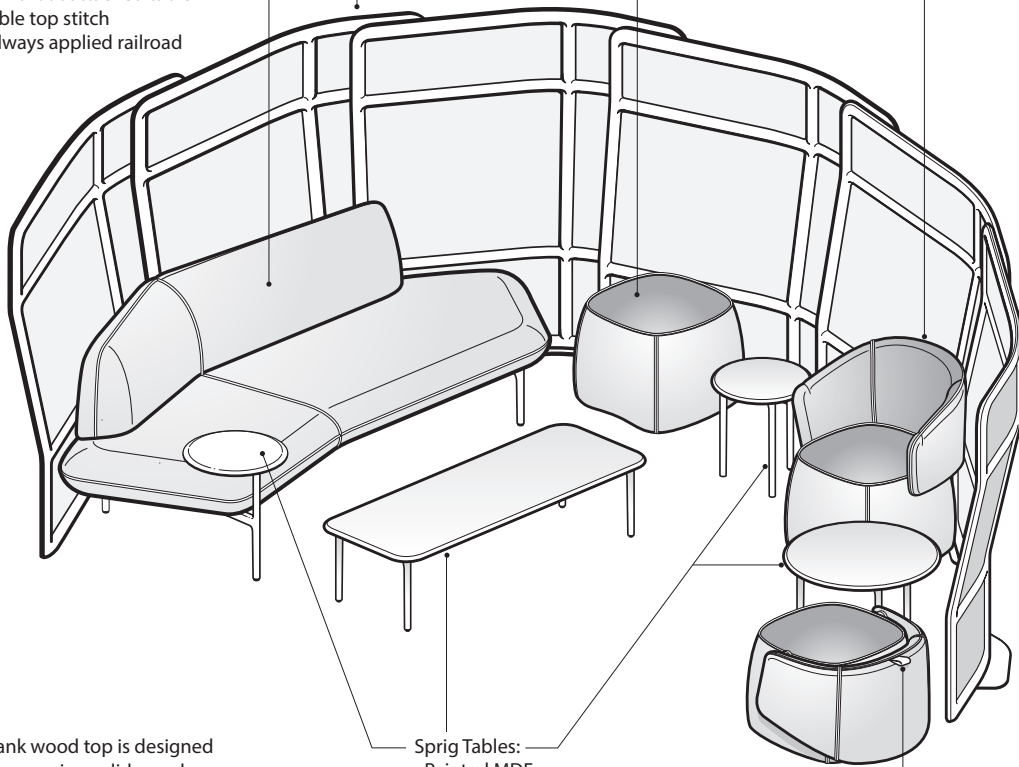

Note - Plank wood top is designed to be unique, using solid wood planks with a clear, low gloss finish allowing visibility of the natural beauty of each wood plank.

- Strig Tables:**
- Painted MDF
 - Plank White Oak
 - Plank Walnut
 - Leg color specified

Pull Tab
• Color not specified, Orange only

Statement of Line

Plume Screens — page 0

Plume 3

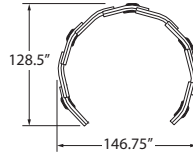
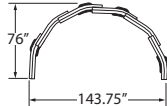
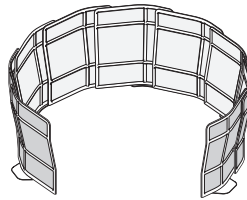
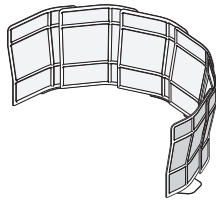
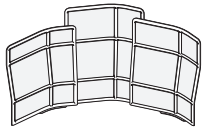

SON-3

SON-6

SON-9

Feather Sofa — page 0

Symmetrical

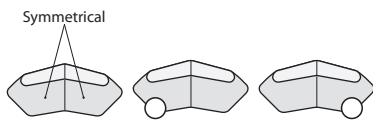
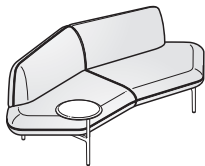

SOSS-1-RW

SOSS-1-N

SOSS-1-RW

SOSS-1-LW

Asymmetrical – Right Hand — page 0

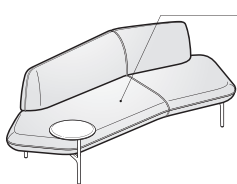

Right Handed (Larger Section At Users Right)

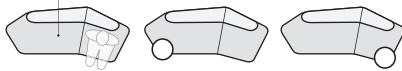

SOSR-1-RW

SOSR-1-N

SOSR-1-RW

SOSR-1-LW

Asymmetrical – Left Hand — page 0

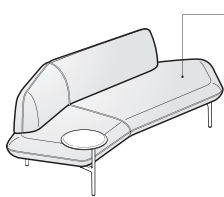

Left Handed (Larger Section At Users Left)

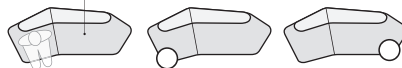

SOSL-1-RW

SOSL-1-N

SOSL-1-RW

SOSL-1-LW

Chick Pouf — page 0

With Back

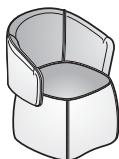

SOPB-22

Outer Surfaces Material Specified: • Always Match
Inner Surfaces Material Specified: • Always Match

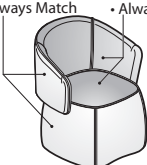

Without Back



SOPN-22



Puck: Color Specified



Thread: Color Specified
Pull Tab: Color Not Specified, Orange Only

Statement of Line

Large Square - No Back — page 0

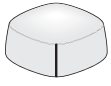

SOPN-2238

Rectangle - No Back — page 0

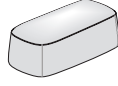

SOPN-2252

Round - No Back — page 0



SOPN-2265

Sprig Tables — page 0

Rectangle

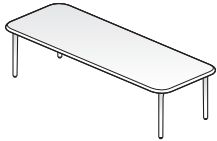

SORA-5320-P

Round



SODB-2424-P



SODC-1616-P

Single Desk — page 0



HOAS-2

Double Desk — page 0

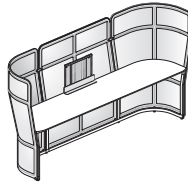

HOAD-3

Privacy Desk — page 0

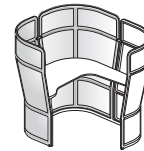

HOAP-3

Single Booth — page 0



HOAB-2

Double Booth — page 0

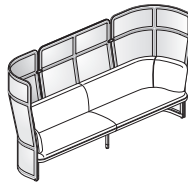

HOA1-3

Corner Booth — page 0

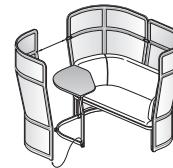

HOAC-3

Privacy Booth — page 0

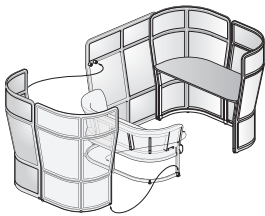

HOAE-5

Conference Booth — page 0

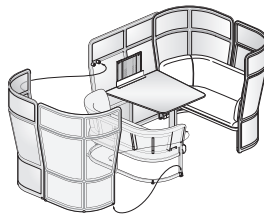

HOAW-5

Height Adjustable Table — page 0

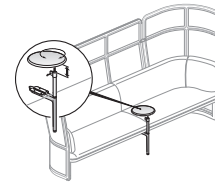

HOUT-1616

Accessories — pages 0-0

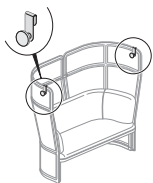

Coat Hook
HOCH



Soft Storage
HOUS

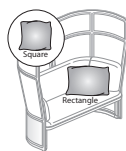

Pillows
HOUP



Hideaway Power Module
HOPD

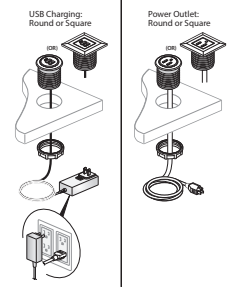

Bezel Utility Module
EURT-0072-1100
EURT-0072-1010

Plume Screens

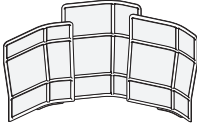
<p>Plume 3</p>  <p>SON-3</p>	<p>Dimensions</p> <p>H: 65"(1651mm) D: 34.5"(876mm) W: 125.75"(3194mm) (Outside) 113.5"(2883mm) (Inside)</p>	<p>Features</p> <ul style="list-style-type: none"> Includes: <ul style="list-style-type: none"> (1) 57"(1448mm)H x 50"(1270mm)W screen, (1) 65"(1651mm)H x 50"(1270mm)W screen, (1) 61"(1549mm)H x 50"(1270mm)W screen. All screens are connected together, not interchangeable. Available in King II, Class II and Maya II fabrics only; COM not available. Floor support and screen connectors in same color. 	<p>To Order, Specify:</p> <ol style="list-style-type: none"> Product number. Inner material. Outer Material. Trim color.
---	--	--	---

	Number	Fabric Grade C	D
	SON-3	\$13128.89	\$15148.73

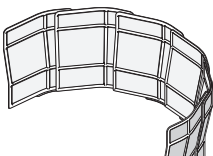
<p>Plume 6</p>  <p>SON-6</p>	<p>Dimensions</p> <p>H: 57"(1448mm) D: 84"(2134mm) W: 143.75"(3651mm) (Outside) 132"(3353mm) (Inside)</p>	<p>Features</p> <ul style="list-style-type: none"> Includes: <ul style="list-style-type: none"> (6) 57"(1448mm)H x 50"(1270mm)W screens. All screens are connected together, not interchangeable. Available in King II, Class II and Maya II fabrics only; COM not available. Floor support and screen connectors in same color. 	<p>To Order, Specify:</p> <ol style="list-style-type: none"> Product number. Inner material. Outer Material. Trim color.
---	---	---	---

	SON-6	\$25247.80	\$28614.22
--	-------	------------	------------

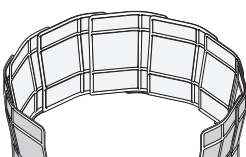
<p>Plume 9</p>  <p>SON-9</p>	<p>Dimensions</p> <p>H: 57"(1448mm) D: 128.5"(3264mm) W: 146.75"(3727mm) (Outside) 131.25"(3334mm) (Inside)</p>	<p>Features</p> <ul style="list-style-type: none"> Includes: <ul style="list-style-type: none"> (9) 57"(1448mm)H x 50"(1270mm)W screens. All screens are connected together, not interchangeable. Available in King II, Class II and Maya II fabrics only; COM not available. Floor support and screen connectors in same color. 	<p>To Order, Specify:</p> <ol style="list-style-type: none"> Product number. Inner material. Outer Material. Trim color.
---	---	---	---

	SON-9	\$37871.78	\$42079.76
--	-------	------------	------------

Note: For mixed grade fabric surfaces, please refer to the electronic design and specification tools for these prices.

Note: The Openest Plume screen is made with polyester fabric adhered to a polyester core. The screen is compliant with UL-1286 flammability requirements and California Technical Bulletin TB-117-2013 requirements. The fabric covering is compliant with NFPA 701 requirements. Consult your local code authority to assure that screens are compliant prior to installation.

Feather Sofa*

Feather – Symmetrical

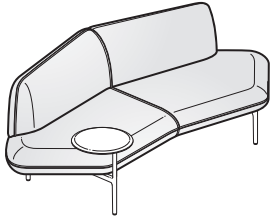

SOSS-1-RW

Dimensions

Sofa

SH: 16.5"(419mm)
 TH: 30.25"(768mm)
 SD: 25"(635mm)
 TD: 37"(940mm)
 W: 87"(2210mm)

Table

H: 19.5"(495mm)
 D: 15.75"(400mm)

Features

- Includes: Sofa with specifiable top-stitch thread and optional side mount table.
- Legs: Painted cast aluminum.
- Optional table:
 - Can be right-side or left-side mounted.
 - Rotates 360°
 - Available in Black, Polar, Stormy or Vapor painted MDF or planked wood in White Oak or Walnut.
 - Planked wood tops are designed to be unique, using solid wood planks with a clear, low-gloss finish showing natural variation.
- COM yardage: 6.5

To Order, Specify:

1) Product number, including:

1 Surface Material:

- 1 Leather
- 2 Fabric
- 3 Faux Leather

2 Table Option:

- N No Table
- R Right Hand Table
- L Left Hand Table

- 2) Surface color.
- 3) Thread color.
- 4) Leg color.
- 5) Table finish (if applicable).

Specification Tips

- Fabric will be applied railroaded.
- Linear or patterned fabric is not recommended due to the manner in which fabric is applied.

Description	Number		Fabric Grade		C	D	E	F	G	H	Leather Grade A	Leather Grade B
	1	2	A	B								
Without Table	SOSS-	-N	\$5049.57	\$5335.71	\$5655.51	\$5891.16	\$6396.13	\$6648.59	\$7195.63	\$7363.96	\$ 9972.89	\$11992.73
With Painted MDF Table	SOSS-	-P	6042.64	6328.78	6648.58	6884.23	7389.20	7641.66	8188.70	8357.03	10965.96	12985.80
With Wood Table - White Oak	SOSS-	-W	6985.22	7271.36	7591.16	7826.81	8331.78	8584.24	9131.28	9299.61	11908.54	13928.38
With Wood Table - Walnut	SOSS-	-W	7111.48	7397.62	7717.42	7953.07	8458.04	8710.50	9257.54	9425.87	12034.80	14054.64

Feather – Asymmetrical

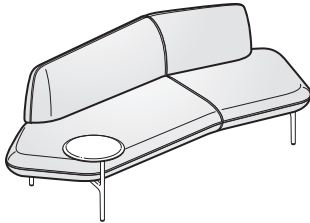

SOSR-1-RW

Dimensions

Sofa

SH: 16.5"(419mm)
 TH: 30.25"(768mm)
 SD: 25"(635mm)
 TD: 37"(940mm)
 W: 92"(2337mm)

Table

H: 19.5"(495mm)
 D: 15.75"(400mm)

Features

- Includes: Sofa with specifiable top-stitch thread and optional side mount table.
- Legs: Painted cast aluminum.
- Optional table:
 - Can be right-side or left-side mounted.
 - Rotates 360°
 - Available in Black, Polar, Stormy or Vapor painted MDF or planked wood in White Oak or Walnut.
 - Planked wood tops are designed to be unique, using solid wood planks with a clear, low-gloss finish showing natural variation.
- COM yardage: 6.75

To Order, Specify:

1) Product number, including:

1 Handedness:

- R Right hand
- L Left hand

2 Surface Material:

- 1 Leather
- 2 Fabric
- 3 Faux Leather

3 Table Option:

- N No Table
- R Right Hand Table
- L Left Hand Table

- 2) Surface color.
- 3) Thread color.
- 4) Leg color.
- 5) Table finish (if applicable).

Specification Tips

- Fabric will be applied railroaded.
- Linear or patterned fabric is not recommended due to the manner in which fabric is applied.
- Handedness determined when seated on sofa.

Description	Number			Fabric Grade		C	D	E	F	G	H	Leather Grade A	Leather Grade B
	1	2	3	A	B								
Without Table	SOS	-	-N	\$5133.72	\$5436.70	\$5764.93	\$6101.55	\$6606.50	\$6901.08	\$7490.19	\$7616.44	\$10048.62	\$12118.96
With Painted MDF Table	SOS	-	-P	6126.79	6429.77	6758.00	7094.62	7599.57	7894.15	8483.26	8609.51	11041.69	13112.03
With Wood Table - White Oak	SOS	-	-W	7069.37	7372.35	7700.58	8037.20	8542.15	8836.73	9425.84	9552.09	11984.27	14054.61
With Wood Table - Walnut	SOS	-	-W	7195.63	7498.61	7826.84	8163.46	8668.41	8962.99	9552.10	9678.35	12110.53	14180.87

The following options require modification of the product number.

Stain Repellent

To specify, add **P** to the end of the product number; **Example:** SOSR-2-RPP (add \$251.28 list)

For sofa without table add **0P** to the end of the product number. **Example:** SOSR-2-N0P

*This product may be subject to supplemental freight charges.

Chick Pouf

Chick Pouf with Back

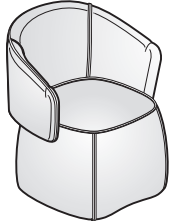

SOPB-2223

Dimensions

SH: 18"(457mm)
 TH: 37.75"(959mm)
 SD: 18.75"(476mm)
 TD: 25.2"(640mm)
 W: 26"(660mm)

Features

- Includes: Seat and back with specifiable top-stitch thread and puck colors.
- Seat back flips up and down.
- Pull tab to flip back up or down available in orange only.
- COM yardage:
 Inner/Outer surfaces matching: 3.5
 Inner Back and Seat only: 1.5
 Outer Back and Base only: 2.0

Specification Tip

- Linear or patterned fabric is not recommended due to the manner in which fabric is applied.

To Order, Specify:

- Product number, including:

1 Inner Surface Material:

- Leather
- Fabric
- Faux Leather

2 Outer Surface Material:

- Leather
- Fabric
- Faux Leather

- Inner Surface Color (Seat, inside back).

- Outer Surface Color (Base, outer back).

- Thread color.

- Puck color.

Number 1 2	Fabric Grade		C	D	E	F	G	H	Leather Grade A	Leather Grade B
	A	B								
SOPB-■ ■ 23-00H	\$2945.54	\$3113.86	\$3341.14	\$3551.52	\$3888.14	\$4064.90	\$4460.38	\$4586.66	\$5554.54	\$6606.48

Chick Pouf without Back

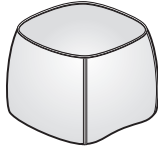

SOPN-2223

Dimensions

H: 18"(457mm)
 D: 22.5"(572mm)
 W: 23.25"(591mm)

Features

- Includes: Seat/Base only with specifiable top-stitch thread color.
- COM yardage:
 Seat and Base matching: 2.75
 Seat only: .75
 Base only: 2.0

Specification Tip

- Linear or patterned fabric is not recommended due to the manner in which fabric is applied.

To Order, Specify:

- Product number, including:

1 Seat Surface Material:

- Leather
- Fabric
- Faux Leather

2 Base Surface Material:

- Leather
- Fabric
- Faux Leather

- Inner Surface Color (Seat).

- Outer Surface Color (Base).

- Thread color.

Number 1 2	Fabric Grade		C	D	E	F	G	H	Leather Grade A	Leather Grade B
	A	B								
SOPN-■ ■ 23-00H	\$1422.30	\$1514.82	\$1657.90	\$1809.42	\$2011.36	\$2127.51	\$2398.51	\$2465.83	\$3281.05	\$4078.89

The following options require modification of the product number.

Stain Repellent

To specify, add **-P** to the end of the product number; **Example:** SOPB-2223-00HP; SOPN-2223-00HP (add **\$126.48** list for Chick Pouf with Back or **\$72.29** for Chick Pouf without Back)

Note: For mixed grade fabric surfaces, please refer to the electronic design and specification tools for these prices.

Chick Pouf

Large Square - No Back



SOPN-2238

Dimensions

H: 17"(432mm)
D: 37.75"(959mm)
W: 37.75"(959mm)

Features

- Includes: Seat and base with specifiable top-stitch thread around the top and down the corners.
- Available with black hard or felt glides.
- COM yardage:
Seat and Base matching: 4.0
Seat only: 1.3
Base only: 2.6

Specification Tips

- Fabric will be applied railroaded.
- Linear or patterned fabric is not recommended due to the manner in which fabric is applied.

To Order, Specify:

1) Product number, including:

1 Seat Surface Material:

- 1 Leather
- 2 Fabric
- 3 Faux Leather

2 Base Surface Material:

- 1 Leather
- 2 Fabric
- 3 Faux Leather

3 Glide Option:

- H Hard Glides
- K Felt Glides

- 2) Seat surface color.
- 3) Base surface color.
- 4) Thread color.

Number 1 2 3	Fabric Grade		C	D	E	F	G	H	Leather Grade A	Leather Grade B
	A	B								
SOPN- 38-00	\$2039.70	\$2175.68	\$2311.64	\$2453.32	\$2583.60	\$3195.53	\$3535.45	\$4147.38	\$3908.67	\$4565.88

Rectangle - No Back

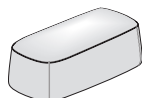

SOPN-2252

Dimensions

H: 18"(457mm)
D: 27"(686mm)
W: 52"(1321mm)

Features

- Includes: Seat and base with specifiable top-stitch thread around the top and down the corners.
- Available with black hard or felt glides.
- COM yardage:
Seat and Base matching: 4.6
Seat only: 2.0
Base only: 2.6

Specification Tips

- Fabric will be applied railroaded.
- Linear or patterned fabric is not recommended due to the manner in which fabric is applied.

To Order, Specify:

1) Product number, including:

1 Seat Surface Material:

- 1 Leather
- 2 Fabric
- 3 Faux Leather

2 Base Surface Material:

- 1 Leather
- 2 Fabric
- 3 Faux Leather

3 Glide Option:

- H Hard Glides
- K Felt Glides

- 2) Seat surface color.
- 3) Base surface color.
- 4) Thread color.

Number 1 2 3	Fabric Grade		C	D	E	F	G	H	Leather Grade A	Leather Grade B
	A	B								
SOPN- 52-00	\$2402.31	\$2560.95	\$2719.58	\$2884.87	\$3036.89	\$3750.02	\$4147.34	\$4861.26	\$4389.11	\$5078.07

The following options require modification of the product number.

Stain Repellent

To specify, add **P** to the end of the product number; **Example:** SOPN-2238-00HP
(Large Square add \$104.25 list; Rectangle add \$122.38 list)

Note: For mixed grade fabric surfaces, please refer to the electronic design and specification tools for these prices.

Chick Pouf

Round - No Back

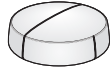

SOPN-2265

Dimensions

H: 17"(432mm)
D: 65"(1651mm)

Features

- Includes: Seat and base with specifiable top-stitch thread around the top, across the middle of the top, and four vertical seams (every 90°).
- Available with black hard or felt glides or six black braking casters.
- Braking casters lock into place when weight is loaded on the pouf.
- COM yardage:
Seat and Base matching: 8.0
Seat only: 4.0
Base only: 4.0

Specification Tips

- Fabric will be applied railroaded.
- Linear or patterned fabric is not recommended due to the manner in which fabric is applied.
- Casters must be specified at time of purchase. Cannot be retrofitted in the field.

To Order, Specify:

1) Product number, including:

1 Seat Surface Material:

- 2** Fabric
- 3** Faux Leather

2 Base Surface Material:

- 2** Fabric
- 3** Faux Leather

3 Glide/Caster Option:

- H** Hard Glides
- K** Felt Glides
- B** Braking Casters (add \$557.51 list)

- 2) Seat surface color.
- 3) Base surface color.
- 4) Thread color.

Number	Fabric Grade			C	D	E	F	G	H	Leather Grade A	Leather Grade B		
	1	2	3									A	B
SOPN- ■ ■ 65-00 ■				\$4441.97	\$4713.93	\$4985.91	\$5269.17	\$5529.77	\$6753.61	\$7433.51	\$8657.31	N/A	N/A

The following options require modification of the product number.

Stain Repellent

To specify, add **P** to the end of the product number; **Example:** SOPN-2265-00HP (add \$208.51 list)

Note: For mixed grade fabric surfaces, please refer to the electronic design and specification tools for these prices.

Sprig Tables

Rectangle

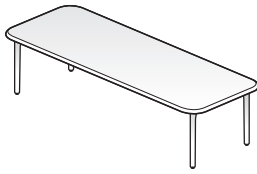

SORA-5320-P

Features

- Includes: Table top and legs.
- Top available in Black, Polar, Stormy or Vapor painted MDF or planked wood in White Oak or Walnut.
- Planked wood tops are designed to be unique, using solid wood planks with a clear, low-gloss finish showing natural variation.
- Legs: Painted cast aluminum.

To Order, Specify:

1) Product number, including:

① Surface Material:

- P** Painted MDF
- W** Planked Wood

2) Top color.

3) Leg color.

Height	Depth	Width	Number ①	Painted	White Oak	Walnut
12"(305mm)	20"(508mm)	53"(1346mm)	SORA-5320-■	\$1397.06	\$3492.64	\$4250.06

Round



SODC-1616-P



SODB-2424-P

Features

- Includes: Table top and legs.
- Top available in Black, Polar, Stormy, or Vapor painted MDF or planked wood in White Oak or Walnut.
- Planked wood tops are designed to be unique, using solid wood planks with a clear, low-gloss finish showing natural variation.
- Legs: Painted cast aluminum.

To Order, Specify:

1) Product number, including:

① Surface Material:

- P** Painted MDF
- W** Planked Wood

2) Top color.

3) Leg color.

Height	Diameter	Number ①	Painted	White Oak	Walnut
17"(432mm)	16"(406mm)	SODC-1616-■	\$ 993.07	\$2019.82	\$2188.15
14"(356mm)	24"(610mm)	SODB-2424-■	1094.06	2709.93	3113.87

Single Desk



HOAS-2

Overall Dimensions

H: 58"(1473mm)
 D: 28"(711mm)
 W: 65"(1651mm)

Features

- Includes: Two screens, one attached worksurface with painted steel structure.
- Worksurface available in painted MDF, laminate or wood veneer.
- Worksurface fixed height 29"(737mm).
- Screens available in King II, Class II, and Maya II fabrics only. COM not available.
- Ships unassembled.

Specification Tips

- Screens are non-load bearing.
- Not reconfigurable.
- Will not accept monitor arms, keyboard pads or attached or suspended pedestals.
- Screens are not tackable or pinnable.
- Separately specified power or USB module field installed.
- For more detailed dimensions, refer to specification guide.

To Order, Specify:

1) Product number, including:

1 Surface Material:

- P** Painted MDF
- L** Laminate
- W** Wood

- 2) Screen inner material.
- 3) Screen outer material.
- 4) Desk surface and color.
- 5) Edgeband color (if applicable).
- 6) Trim color.

Number 1	Screen Grade C	Laminate Worksurface		Wood Worksurface	
	Painted MDF Worksurface Price	Grade A	Grade B	Grade A	Grade B
HOAS-2-N NNS	\$11112.32	\$10622.07	\$10703.78	\$11194.04	\$11275.74

Number 1	Screen Grade D	Laminate Worksurface		Wood Worksurface	
	Painted MDF Worksurface Price	Grade A	Grade B	Grade A	Grade B
HOAS-2-N NNS	\$11929.38	\$11439.13	\$11520.84	\$12011.10	\$12092.80

Note: For mixed grade fabric surfaces, please refer to the electronic design and specification tools for these prices.

Note: The Openest screen is made with polyester fabric adhered to a polyester core. The screen is compliant with UL-1286 flammability requirements and California Technical Bulletin TB-117-2013 requirements. The fabric covering is compliant with NFPA 701 requirements. Consult your local code authority to assure that screens are compliant prior to installation.

Double Desk

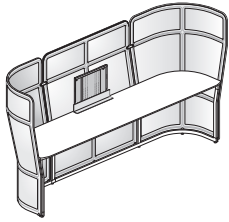

HOAD-3

Overall Dimensions

H: 58”(1473mm)
 D: 28”(711mm)
 W: 117”(2972mm)

Features

- Includes: Three screens, one attached worksurface with painted steel structure and monitor mount (if applicable).
- Worksurface available in painted MDF, laminate or wood veneer.
- Worksurface fixed height 29”(737mm).
- Monitor mount accepts 40”(1016mm)-42”(1067mm) monitors.
- Screens available in King II, Class II and Maya II fabrics only. COM not available.
- Monitor mount.
 - Table mounting bracket mounts unit to worksurface and supports monitor in a viewing position. Standard in black.
 - Front and rear trim match trim specification and hides cables and wires behind the monitor.
- Ships unassembled.

Specification Tips

- Not reconfigurable.
- Soft Storage cannot be used on the Double Desk.
- Coat Hook not to be used with mounted monitor.
- Will not accept monitor arms, keyboard pads or attached or suspended pedestals.
- Screens are not tackable or pinnable.
- Separately specified power or USB module field installed.
- For more detailed dimensions, refer to specification guide.

To Order, Specify:

1) Product number, including:

1 Surface Material:

- P** Painted MDF
- L** Laminate
- W** Wood

2 Monitor Mount:

- N** No Monitor Mount
- M** Monitor Mount, add **\$1634.17** list

- 2) Screen inner material.
- 3) Screen outer material.
- 4) Desk surface and color.
- 5) Edgeband color (if applicable).
- 6) Trim color.

Number 1 2	Screen Grade C	Laminate Worksurface		Wood Worksurface	
	Painted MDF Worksurface Price	Grade A	Grade B	Grade A	Grade B
HOAD-3-N ■ ■ NS	\$16668.49	\$15851.42	\$16014.83	\$16750.22	\$16913.63

Number 1 2	Screen Grade D	Laminate Worksurface		Wood Worksurface	
	Painted MDF Worksurface Price	Grade A	Grade B	Grade A	Grade B
HOAD-3-N ■ ■ NS	\$17812.43	\$16995.36	\$17158.77	\$17894.16	\$18057.57

Note: For mixed grade fabric surfaces, please refer to the electronic design and specification tools for these prices.

Note: The Openest screen is made with polyester fabric adhered to a polyester core. The screen is compliant with UL-1286 flammability requirements and California Technical Bulletin TB-117-2013 requirements. The fabric covering is compliant with NFPA 701 requirements. Consult your local code authority to assure that screens are compliant prior to installation.

Privacy Desk

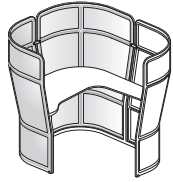

HOAP-3
(Right-hand shown)

Dimensions

H: 58"(1473mm)
D: 65"(1651mm)
W: 55"(1397mm)

Features

- Includes: Three screens, one attached worksurface and steel structure.
- Worksurface available in painted MDF, laminate or wood veneer.
- Worksurface fixed height 29"(737mm).
- Screens available in King II, Class II and Maya II fabrics only. COM not available.
- Painted steel structure.
- Ships unassembled.

Specification Tips

- Screens are non-load bearing.
- Not reconfigurable.
- Will not accept monitor arms, keyboard pads or attached or suspended pedestals.
- Screens are not tackable or pinnable.
- Separately specified power or USB module field installed.
- Handedness determined by return location.
- For more detailed dimensions, refer to specification guide.

To Order, Specify:

1) Product number, including:

1 Surface Material:

- P** Painted MDF
- L** Laminate
- W** Wood

2 Handedness:

- R** Right-Hand
- L** Left-Hand

- 2) Screen inner material.
- 3) Screen outer material.
- 4) Desk surface and color.
- 5) Edgeband color (if applicable).
- 6) Trim color.

Number 1 2	Screen Grade C	Laminate Worksurface		Wood Worksurface	
	Painted MDF Worksurface Price	Grade A	Grade B	Grade A	Grade B
HOAP-3-N <input type="checkbox"/> N <input type="checkbox"/> S	\$16178.26	\$15524.59	\$15647.15	\$16259.96	\$16382.56

Number 1 2	Screen Grade D	Laminate Worksurface		Wood Worksurface	
	Painted MDF Worksurface Price	Grade A	Grade B	Grade A	Grade B
HOAP-3-N <input type="checkbox"/> N <input type="checkbox"/> S	\$17322.20	\$16668.53	\$16791.09	\$17403.90	\$17526.50

Note: For mixed grade fabric surfaces, please refer to the electronic design and specification tools for these prices.

Note: The Openest screen is made with polyester fabric adhered to a polyester core. The screen is compliant with UL-1286 flammability requirements and California Technical Bulletin TB-117-2013 requirements. The fabric covering is compliant with NFPA 701 requirements. Consult your local code authority to assure that screens are compliant prior to installation.

Single Booth

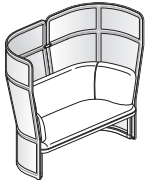

HOAB-2

Dimensions:

- SH: 18"(457mm)
- H: 58"(1473mm)
- SD: 20"(508mm)
- TD: 30"(762mm)
- SW: 44"(1118mm)
- TW: 65"(1651mm)

Features

- Includes: Two screens, one attached sofa with specifiable top-stitch thread and painted steel structure.
- Screens available in King II, Class II and Maya II fabrics only. COM not available.
- Ships unassembled.
- COM yardage/sq. footage (sofa): 3.25 / 58.5

Specification Tips

- Screens are non-load bearing.
- Not reconfigurable.
- Screens are not tackable or pinnable.
- Sofa accepts separately specified and field installed Hideaway Power Module.
- Sofa fabric applied railroaded.
- Linear or patterned fabric not recommended due to the manner in which fabric is applied.
- For more detailed dimensions, refer to specification guide.

To Order, Specify:

1) Product number, including:

1 Seat Surface Material:

- 1** Leather
- 2** Fabric
- 3** Faux Leather

- 2) Screen inner material.
- 3) Screen outer material.
- 4) Sofa material and color.
- 5) Thread color.
- 6) Trim color.

Number 1	Screen Grade C Seat Grade								Leather Grade A	Leather Grade B
	A	B	C	D	E	F	G	H		
HOAB-2- ■ NNNN	\$13481.87	\$13726.99	\$13767.86	\$13890.40	\$14053.84	\$14176.38	\$14462.37	\$14552.26	\$16750.21	\$17567.26

Number 1	Screen Grade D Seat Grade								Leather Grade A	Leather Grade B
	A	B	C	D	E	F	G	H		
HOAB-2- ■ NNNN	\$14298.93	\$14544.05	\$14584.92	\$14707.46	\$14870.90	\$14993.44	\$15279.43	\$15369.32	\$17567.27	\$18384.32

The following options require modification of the product number.

Stain Repellent

To specify, add **P** to the end of the product number; **Example:** HOAB-2-2NNNNP (add \$117.45 list)

Note: For mixed grade fabric surfaces, please refer to the electronic design and specification tools for these prices.

Note: The Openest screen is made with polyester fabric adhered to a polyester core. The screen is compliant with UL-1286 flammability requirements and California Technical Bulletin TB-117-2013 requirements. The fabric covering is compliant with NFPA 701 requirements. Consult your local code authority to assure that screens are compliant prior to installation.

Double Booth

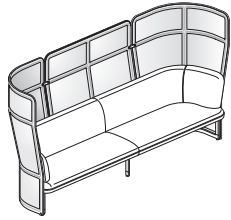

HOA1-3

Dimensions:

- SH: 18”(457mm)
- H: 58”(1473mm)
- SD: 20”(508mm)
- TD: 30”(762mm)
- SW: 96”(2438mm)
- TW: 108”(2743mm)

Features

- Includes: Three screens, attached double sofa with specifiable top-stitch thread and painted steel structure. Double sofa shipped in two pieces.
- Screens available in King II, Class II and Maya II fabrics only. COM not available.
- Ships unassembled.
- COM yardage/sq. footage (sofa): 6 / 108

Specification Tips

- Screens are non-load bearing.
- Not reconfigurable.
- Screens are not tackable or pinnable.
- Separately specified Hideaway Power Module field installed.
- Sofa fabric applied railroaded.
- For more detailed dimensions, refer to specification guide.

To Order, Specify:

1) Product number, including:

1 Seat Surface Material:

- 1 Leather
- 2 Fabric
- 3 Faux Leather

- 2) Screen inner material.
- 3) Screen outer material.
- 4) Sofa surface and color.
- 5) Thread color.
- 6) Trim color.
- 7) Table color/finish (if applicable).

Description	Number 1	Screen Grade C								Leather Grade A	Leather Grade B
		Seat Grade									
		A	B	C	D	E	F	G	H		
No Table	HOA1-3-NNNN	\$25329.55	\$25819.80	\$25901.52	\$26146.62	\$26473.46	\$26718.60	\$27290.55	\$27470.31	\$31866.20	\$33500.39
Painted Table	HOA1-3-PNHN	26685.91	27176.16	27257.88	27502.98	27829.82	28074.96	28646.91	28826.67	33222.56	34856.75
White Oak Table	HOA1-3-WNHN	29055.45	29545.70	29627.42	29872.52	30199.36	30444.50	31016.45	31196.21	35592.10	37226.29
Walnut Table	HOA1-3-WNHN	29349.59	29839.84	29921.56	30166.66	30493.50	30738.64	31310.59	31490.35	35886.24	37520.43

Description	Number 1	Screen Grade D								Leather Grade A	Leather Grade B
		Seat Grade									
		A	B	C	D	E	F	G	H		
No Table	HOA1-3-NNNN	\$26473.49	\$26963.74	\$27045.46	\$27290.56	\$27617.40	\$27862.54	\$28434.49	\$28614.25	\$33010.14	\$34644.33
Painted Table	HOA1-3-PNHN	27829.85	28320.10	28401.82	28646.92	28973.76	29218.90	29790.85	29970.61	34366.50	36000.69
White Oak Table	HOA1-3-WNHN	30199.39	30689.64	30771.36	31016.46	31343.30	31588.44	32160.39	32340.15	36736.04	38370.23
Walnut Table	HOA1-3-WNHN	30493.53	30983.78	31065.50	31310.60	31637.44	31882.58	32454.53	32634.29	37030.18	38664.37

The following options require modification of the product number.

Stain Repellent

To specify, add **P** to the end of the product number; **Example:** HOA1-3-2NNNNP (add \$216.85 list)

Note: For mixed grade fabric surfaces, please refer to the electronic design and specification tools for these prices.

Note: The Openest screen is made with polyester fabric adhered to a polyester core. The screen is compliant with UL-1286 flammability requirements and California Technical Bulletin TB-117-2013 requirements. The fabric covering is compliant with NFPA 701 requirements. Consult your local code authority to assure that screens are compliant prior to installation.

Corner Booth

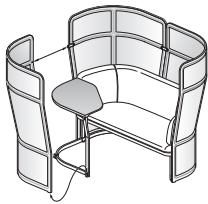

HOAC-3
(Right-hand shown)

Dimensions:

- SH: 18"(457mm)
- H: 58"(1473mm)
- SD: 20"(508mm)
- TD: 55"(1397mm)
- SW: 44"(1118mm)
- TW: 65"(1651mm)

Worksurface Dimensions:

- H: 29"(737mm)
- D: 24"(610mm)
- W: 29"(737mm)

Features

- Corner Booth must be **ordered as two individual items**:
 - Item 1 includes: Three screens, one attached sofa with specifiable top-stitch thread and painted steel structure.
 - Item 2 includes: Corner worksurface.
- Screens available in King II, Class II and Maya II fabrics only. COM not available.
- Worksurface available in painted MDF, laminate or wood veneer.
- Worksurface fixed height is 29"(737mm).
- Ships unassembled.
- COM yardage/sq. footage (sofa): 3.25 / 58.5

Specification Tips

- Screens are non-load bearing.
- Will not accept monitor arms, keyboard pads or attached or suspended pedestals.
- Not reconfigurable.
- Screens are not tackable or pinnable.
- Separately specified power or USB module field installed.
- Sofa accepts separately specified and field installed Hideaway Power Module.
- Handedness determined from a seated position.
- Sofa fabric applied railroaded.
- Linear or patterned fabric not recommended due to the manner in which fabric is applied.
- For more detailed dimensions, refer to specification guide.

To Order, Specify:

ITEM #1

1) Product number, including:

1 Seat Surface Material:

- 1** Leather
- 2** Fabric
- 3** Faux Leather

2 Handedness:

- R** Right-Hand
- L** Left-Hand

- 2) Screen inner material.
- 3) Screen outer material.
- 4) Sofa surface and color.
- 5) Thread color.
- 6) Trim color.

To Order, Specify:

ITEM #2

1) Product number, including:

1 Surface Material:

- P** Painted MDF
- L** Laminate
- W** Wood

2 Handedness:

- R** Right-Hand
- L** Left-Hand

- 2) Surface and color.
- 3) Edgeband color (if applicable).

ITEM #1 – Screens and Sofa

Number 1 2	Screen Grade C								Leather Grade A	Leather Grade B
	Seat Grade									
	A	B	C	D	E	F	G	H		
HOAC-3- ■ NN ■ N	\$17975.82	\$18220.94	\$18261.81	\$18384.35	\$18547.79	\$18670.33	\$18956.32	\$19046.21	\$21244.16	\$22061.21

Number 1 2	Screen Grade D								Leather Grade A	Leather Grade B
	Seat Grade									
	A	B	C	D	E	F	G	H		
HOAC-3- ■ NN ■ N	\$19119.76	\$19364.88	\$19405.75	\$19528.29	\$19691.73	\$19814.27	\$20100.26	\$20190.15	\$22388.10	\$23205.15

ITEM #2 – Worksurface

Number 1 2	Painted MDF Worksurface	Laminate Worksurface		Wood Worksurface	
	Price	Grade A	Grade B	Grade A	Grade B
HOAC-W-N ■ N ■ S	\$939.64	\$612.82	\$670.02	\$939.64	\$1021.35

The following options require modification of the product number.

Stain Repellent

To specify, add **P** to the end of the product number; **Example:** HOAC-3-2NNRNP (add \$117.45 list)

Note: For mixed grade fabric surfaces, please refer to the electronic design and specification tools for these prices.

Note: The Openest screen is made with polyester fabric adhered to a polyester core. The screen is compliant with UL-1286 flammability requirements and California Technical Bulletin TB-117-2013 requirements. The fabric covering is compliant with NFPA 701 requirements. Consult your local code authority to assure that screens are compliant prior to installation.

Privacy Booth

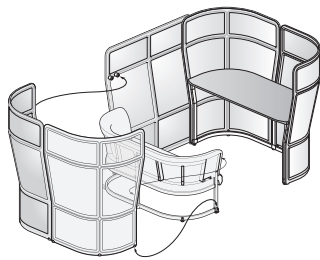

HOAE-5
(Left-hand shown)

Dimensions:

SH: 18"(457mm)
H: 58"(1473mm)
SD: 20"(508mm)
TD: 67"(1702mm)
SW: 44"(1118mm)
TW: 94"(2388mm)

Worksurface Dimensions:

H: 29"(737mm)
D: 25"(635mm)
W: 57"(1448mm)

Features

- Privacy Booth must be **ordered as two individual items**:
 - Item 1 includes: Five screens, one attached sofa with specifiable top-stitch thread and painted steel structure.
 - Item 2 includes: Worksurface.
- Screens available in King II, Class II and Maya II fabrics only. COM not available.
- Worksurface available in painted MDF, laminate or wood veneer.
- Worksurface fixed height is 29"(737mm).
- Open space between the sofa and worksurface is 42"(1067mm).
- Ships unassembled.
- COM yardage/sq. footage (sofa): 3.25 / 58.5

Specification Tips

- Screens are non-load bearing.
- Not reconfigurable.
- Handedness determined by sofa side.
- Will not accept monitor arms, keyboard pads or attached or suspended pedestals.
- Screens are not tackable or pinnable.
- Separately specified power or USB module field installed.
- Sofa accepts separately specified and field installed Hideaway Power Module.
- Sofa fabric applied railroaded.
- Linear or patterned fabric not recommended due to the manner in which fabric is applied.
- For more detailed dimensions, refer to specification guide.

To Order, Specify:

ITEM #1

1) Product number, including:

1 Seat Surface Material:

- 1 Leather
- 2 Fabric
- 3 Faux Leather

2 Handedness:

- R Right-Hand
- L Left-Hand

- 2) Screen inner material.
- 3) Screen outer material.
- 4) Sofa surface and color.
- 5) Thread color.
- 6) Trim color.

To Order, Specify:

ITEM #2

1) Product number, including:

1 Surface Material:

- P Painted MDF
- L Laminate
- W Wood

- 2) Surface and color.
- 3) Edgeband color (if applicable).

ITEM #1 – Screens and Sofa

Number	Screen Grade C								Leather Grade A	Leather Grade B		
	1	2	A	B	C	D	E	F			G	H
HOAE-5- <input type="checkbox"/> NN <input type="checkbox"/> N			\$25738.11	\$25983.23	\$26024.10	\$26146.64	\$26310.08	\$26432.62	\$26718.61	\$26808.50	\$29006.45	\$29823.50

Number	Screen Grade D								Leather Grade A	Leather Grade B		
	1	2	A	B	C	D	E	F			G	H
HOAE-5- <input type="checkbox"/> NN <input type="checkbox"/> N			\$27208.85	\$27453.97	\$27494.84	\$27617.38	\$27780.82	\$27903.36	\$28189.35	\$28279.24	\$30477.19	\$31294.24

ITEM #2 – Worksurface

Number	1	Painted MDF Worksurface Price		Laminate Worksurface		Wood Worksurface	
		Grade A	Grade B	Grade A	Grade B	Grade A	Grade B
HOAE-W-N	<input type="checkbox"/> NNS	\$1266.47		\$776.22	\$857.93	\$1348.19	\$1429.89

The following options require modification of the product number.

Stain Repellent

To specify, add **P** to the end of the product number; **Example:** HOAE-5-2NNRNP (add \$117.45 list)

Note: For mixed grade fabric surfaces, please refer to the electronic design and specification tools for these prices.

Note: The Openest screen is made with polyester fabric adhered to a polyester core. The screen is compliant with UL-1286 flammability requirements and California Technical Bulletin TB-117-2013 requirements. The fabric covering is compliant with NFPA 701 requirements. Consult your local code authority to assure that screens are compliant prior to installation.

Conference Booth

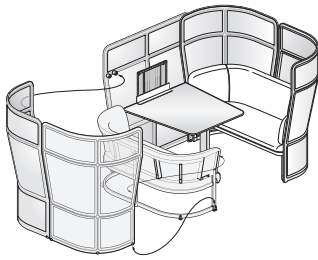

HOAW-5
(shown with monitor mount)

Dimensions:

- SH: 18"(457mm)
- H: 58"(1473mm)
- SD: 20"(508mm)
- TD: 67"(1702mm)
- SW: 44"(1118mm)
- TW: 94"(2388mm)

Worksurface Dimensions:

- H: 29"(737mm)
- D: 46"(1168mm)
- W: 40"(1016mm)

Features

- Conference Booth must be **ordered as two individual items:**
 - Item 1 includes: Five screens, two attached sofas with specifiable top-stitch thread and painted steel structure.
 - Item 2 includes: Worksurface and monitor mount (if specified).
- Screens available in King II, Class II and Maya II fabrics only. COM not available.
- Worksurface available in painted MDF, laminate or wood veneer.
- Worksurface fixed height is 29"(737mm).
- Monitor mount accepts 30"(762mm)-32"(813mm) monitor only.
 - Table mounting bracket mounts unit to worksurface and supports monitor in a viewing position. Standard in black.
 - Front and rear trim match trim specification and hides cables and wires behind the monitor.
- Ships unassembled.
- COM yardage/sq. footage (sofa): 3.25 / 58.5

Specification Tips

- Not reconfigurable.
- Will not accept monitor arms, keyboard pads or attached or suspended pedestals.
- Screens are not tackable or pinnable.
- Separately specified power or USB module field installed.
- Sofa accepts separately specified and field installed Hideaway Power Module.
- Sofa fabric applied railroaded.
- Linear or patterned fabric not recommended due to the manner in which fabric is applied.
- For more detailed dimensions, refer to specification guide.

To Order, Specify:

ITEM #1

- 1) Product number, including:

1 Seat Surface Material:

- 1** Leather
- 2** Fabric
- 3** Faux Leather

- 2) Screen inner material.
- 3) Screen outer material.
- 4) Sofa surface and color.
- 5) Thread color.
- 6) Trim color.

To Order, Specify:

ITEM #2

- 1) Product number, including:

1 Surface Material:

- P** Painted MDF
- L** Laminate
- W** Wood

2 Monitor Mount:

- N** No Monitor Mount
- M** Monitor Mount, add **\$1634.17** list

- 2) Surface and color.
- 3) Edgeband color (if applicable).
- 4) Trim color.

ITEM #1 – Screens and Sofa

Number 1	Screen Grade C								Leather Grade A	Leather Grade B
	Seat Grade									
	A	B	C	D	E	F	G	H		
HOAW-5- ■ NNNN	\$32193.05	\$32683.30	\$32765.02	\$33010.12	\$33336.96	\$33582.10	\$34154.05	\$34333.81	\$38729.70	\$40363.89

Number 1	Screen Grade D								Leather Grade A	Leather Grade B
	Seat Grade									
	A	B	C	D	E	F	G	H		
HOAW-5- ■ NNNN	\$33663.79	\$34154.04	\$34235.76	\$34480.86	\$34807.70	\$35052.84	\$35624.79	\$35804.55	\$40200.44	\$41834.63

ITEM #2 – Worksurface

Number 1 2	Painted MDF Worksurface		Laminate Worksurface		Wood Worksurface	
	Price		Grade A	Grade B	Grade A	Grade B
HOAW-W-N ■ ■ NS	\$1429.89		\$776.22	\$898.78	\$1511.59	\$1634.19

The following options require modification of the product number.

Stain Repellent

To specify, add **P** to the end of the product number; **Example:** HOAW-5-2NNNNP (add **\$234.91** list)

Note: For mixed grade fabric surfaces, please refer to the electronic design and specification tools for these prices.

Note: The Openest screen is made with polyester fabric adhered to a polyester core. The screen is compliant with UL-1286 flammability requirements and California Technical Bulletin TB-117-2013 requirements. The fabric covering is compliant with NFPA 701 requirements. Consult your local code authority to assure that screens are compliant prior to installation.

Height Adjustable Table

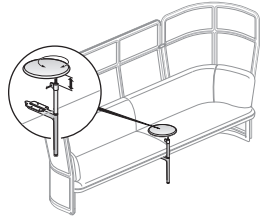

HOUT-1616

Dimensions

H: 20-24"(508-610mm)
 D: 16"(406mm)
 W: 16"(406mm)

Features

- Includes: Table top and height adjustable leg.
- Top available in painted MDF or plank wood.
- Planked wood tops are designed to be unique, using solid wood planks with a clear, low-gloss finish showing natural variation.
- Legs: Painted cast aluminum.
- Top rotates 360°.
- Height adjustment range is 4"(102mm).

Specification Tip

- For use on all Openest sofas.

To Order, Specify:

1) Product number, including:

1 Sofa Type:

B Booth

F Feather

2 Surface Material:

P Painted MDF

W Planked Wood

2) Surface and color.

3) Trim color.

Number 1 2

HOUT-1616-■ ■

Painted

\$1514.86

**Wood
White Oak**

\$2558.42

Walnut

\$2861.42

Accessories

Coat Hook

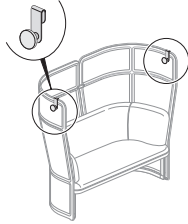

HOCH

Dimensions:

H: 7.7"(196mm)
 D: 1.6"(41mm)
 W: 3"(76mm)

Features

- Includes: One white oak coat hook.
- Painted steel bracket with white oak wood surface.
- Maximum weight load is 10 lbs.

To Order, Specify:

- 1) Product number.
- 2) Trim color.

Specification Tips

- Can be used on Plume screens.
- Cannot be hung on the backside of Double Desk with monitor mount.

Number

HOCH-0000

Price

\$252.47

Soft Storage

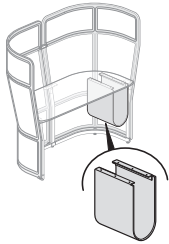

HOUS

Dimensions:

H: 12"(305mm)
 D: 16"(406mm)
 W: 8.5"(216mm)

Features

- Includes: One soft storage unit with attachment hardware.
- Maximum weight capacity is 30 lbs.
- Available in Big Arrow fabric only. COM not available.

To Order, Specify:

- 1) Product number.
- 2) Fabric color.

Specification Tips

- Can be used on worksurfaces 16"(406mm) or deeper.
- Not for use on sofas.
- Not for use on Double Desk.

Number

HOUS-0000

Price

\$420.79

Pillows

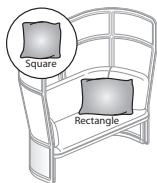

HOUP

Features

- Includes: One pillow with 100% polyester fill.
- Available in square or rectangle.
- COM yardage: 0.75

To Order, Specify:

- 1) Product number.
- 2) Fabric color.

Description	Height	Width	Number	Fabric Grade							
				A	B	C	D	E	F	G	H
Square	18"(457mm)	18"(457mm)	HOUP-S	\$260.90	\$548.75	\$575.64	\$602.57	\$629.51	\$708.52	\$892.82	\$950.75
Rectangle	16"(406mm)	20"(508mm)	HOUP-R	260.90	548.75	575.64	602.57	629.51	708.52	892.82	950.75

The following options require modification of the product number.

Stain Repellent

To specify, add **-P** to the end of the product number; **Example:** HOUP-S-P (add \$27.11 list)

Hideaway Power Module

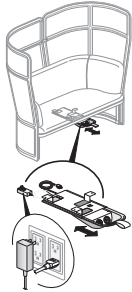

HOPD

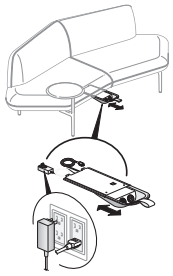

Features

- Includes: Power drawer, soft drawer pull, power and/or USB ports and mounting hardware.
- Power options include: One power port and one USB port, two power ports, or two USB ports.
- UL listed power outlet provides one NEMA 5-15R outlet.
- USB outlet consists of two USB outlets with 1000mA of charging per USB outlet powered from UL listed transformer.
- Can be used on Openest booth sofa or Feather sofa.
- Mounts to under structure of sofa.
- Tray slides 6”(152mm) forward.
- Drawer available in supplier white only.
- Drawer pull in orange only.

To Order, Specify:

- 1) Product number, including:
(No finish specification required.)

1 Sofa Type:

- B** Booth
- F** Feather

Specification Tips

- For use with 120 volt 60 hertz power source only.
- Drawer has one cord with plug (NEMA 5-15P) and one cord with 2”(51mm) x 1”(25mm) x 3”(76mm) voltage transformer plug. Transformer may block adjacent outlets (see illustration).
- Cord reach is 30”(762mm) from back of hideaway power module.
- Requires field installation.
- Application may require approval of local authority having jurisdiction (AHJ); ensure compliance before placing orders and installing.

Description	Height	Depth	Width	Number 1	Price
1 Power, 1 USB Port	3.2”(81mm)	15.5”(394mm)	9.2”(234mm)	HOPD-0006- 11100	\$1127.72
2 Power Ports				HOPD-0006- 12000	1043.56
2 USB Ports				HOPD-0006- 10200	1363.37

Bezel Utility Module

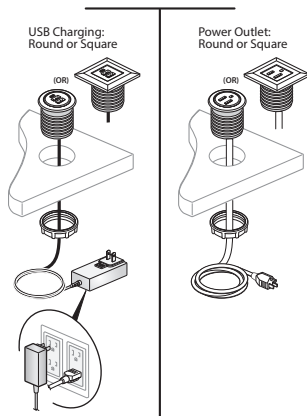

EURT-0072-1100
EURT-0072-1010



Features

- Includes: Either a round or square faced Power Module and mounting hardware.
- For use on surfaces 0.75"(19mm) - 1.44"(37mm) thick.
- Available with either:
 - One power outlet (NEMA 5-15R)
 - One two port USB charger. Consists of two USB outlets with 1000mA of charging power (5 volts) per USB outlet.
- Available in black or supplier white only.

Specification Tips

- For use with 120 volt 60 hertz power source only.
- Power configuration has one cord with plug (NEMA 5-15P).
- USB configuration has one cord with 2"(51mm) x 1"(25mm) x 3"(76mm) voltage transformer plug. Transformer may block adjacent outlets (see illustration).
- Requires field cut 1.75"(44mm) hole and field installation.
- Application may require approval of local authority having jurisdiction (AHJ); ensure compliance before placing orders and installing.

To Order, Specify:

1) Product number, including:

1 Shape:

S Square

C Round

2 Color Options:

B Black

W White

Description	Height	Depth	Width	Number	1 2	Price
6' Cord						
Power		1.75"(44mm)		EURT-0072-1100	■ ■	\$120.54
USB				EURT-0072-1010	■ ■	361.66
12' Cord						
Power		1.75"(44mm)		EURT-00E4-1100	■ ■	\$206.65
USB				EURT-00E4-1010	■ ■	447.77

Data Bezel

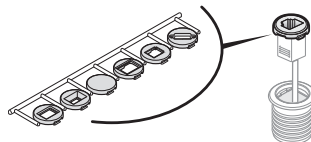

EURT-0000-N001CB
EURT-0000-N001CW

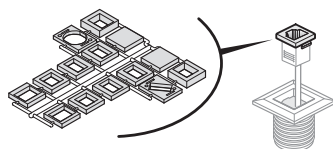

EURT-0000-N001SB
EURT-0000-N001SW

Description	Number	Price
Round		
Black	EURT-0000-N001CB	\$120.54
White	EURT-0000-N001CW	120.54
Square		
Black	EURT-0000-N001SB	\$120.54
White	EURT-0000-N001SW	120.54

Feature

- Includes one round or square bezel for the Bezel Utility Module.
- Available in black or supplier white only.

To Order, Specify:

1) Product number.
(No finish specification required.)

Finish/Color Legend

Wood Finishes

Grade A
Double Cut

WE-RD	Dune
WJ-RE	Ebony
2N-RL	Echo
W3-HR	Harbor
WE-RT	Melba
W4-PB	Pebble
CQ-WG	Walnut Grove

Grade B
Cherry

VC-CA1	Amber
VC-W23	American
VC-W33	Caramel
VC-W30	Heritage
VC-W32	Pacific

Maple

VP-LM	Light
VP-N	Natural

Maple Quarter Cut

NM-N	Natural
------	---------

Rift Cut White Oak

NR-W35	Clear
NR-W15	Espresso
NR-W40	Mocha

Walnut

VR-W15	Espresso
VR-W31	Retro

Walnut Quarter Cut

NW-W35	Clear
NW-W15	Espresso
NW-W31	Retro

Planked Wood

VB-W35	Plank Oak
VH-W35	Plank Walnut

Laminate

Grade A
Solid Color

H-34	Beige
H-AK	Chalk
H-8J	Charcoal
H-3J	Graphite
H-62	Gray Tone
H-WL	Linen
H-3P	Platinum
H-AA	Putty
H-3E	Smoke

Patterned

H-P1	Linen Casual
H-P2	Linen Classic
H-P3	Linen Crisp
H-P4	Linen Flax

Wood Grain

H-AE	Maple
------	-------

Grade B
Premium Wood Grain

H-KA	Brazilwood
H-KG	Columbian Walnut
H-KP	Field Elm
H-KN	Grey Elm
H-KM	Landmark Wood
H-KL	Neo Walnut
H-KC	New Age Oak
H-KR	Phantom Ecru
H-KS	Phantom Pearl
H-KD	River Cherry
H-KF	Williamsburg Cherry

Edgeband

Solid Color

HP-34	Beige
HP-AK	Chalk
HP-8J	Charcoal
HP-3J	Graphite
HP-62	Gray Tone
HP-WL	Linen
HP-3P	Platinum
HP-AA	Putty
HP-3E	Smoke

Patterned Edgeband

HP-P1	Linen Casual
HP-P2	Linen Classic
HP-P3	Linen Crisp
HP-P4	Linen Flax

Wood Grain

HP-KA	Brazilwood
HP-KG	Columbian Walnut
HP-KP	Field Elm
HP-KN	Grey Elm
HP-KM	Landmark Wood
HP-AE	Maple
HP-KL	Neo Walnut
HP-KC	New Age Oak
HP-KR	Phantom Ecru
HP-KS	Phantom Pearl
HP-KD	River Cherry
HP-KF	Williamsburg Cherry

Ply-Edge

HP-PW	Ply-Edge
-------	----------

Trim Color

TR-F	Black
TR-RR	Rusty Red
TR-PLS	Smooth Plaster

Painted MDF

PW-F	Black
PW-AK	Chalk
PW-PL	Polar
PW-SY	Stormy
PW-VA	Vapor

Thread Colors

NS-1E	Accent Orange
NS-F	Black
NS-RR	Rusty Red
NS-SN	Sand
NS-PLS	Smooth Plaster

ALERT: These materials are current, however they are being considered for future obsolescence due to low volume.

Wood:

VJ-W42	Brindle
2R-RL	Butternut
NP-W08	Golden
NP-W07	Light
NX-U	Medium
VJ-W05	Natural
VR-W12	Naturally Walnut
VP-AD	Sand
WC-RW	Wenge

Laminate:

H-AM	Amber Cherry
H-AD	Medium Cherry

Edgeband:

HP-AM	Amber Cherry
HP-AD	Medium Cherry

Trim Color:

TR-1E	Accent Orange
-------	---------------

Forest Stewardship Council® (FSC®) Statement: In our continuing support of sustainable forestry and responsible purchasing, Haworth North America is offering FSC certified wood products at no up-charge. By providing FSC certified material, Haworth is supporting our client's green building goals and demonstrating our collective commitment to source materials more sustainably.

Haworth will provide to you the necessary FSC-certified paperwork with your shipment. For more information, FAQs, and a complete FSC product list (including product exceptions), go to the Library and search FSC.

Haworth FSC Trademark License
#FSC-C002821

Fabrics/Color Legends

Haworth seating models are restricted to fabric patterns that meet applicability standards for tailoring. A dot in the matrix below indicates fabric acceptability on seating series or specific models listed. Fabrics are listed alphabetically by grades.

Grade: Pattern (Surface Code)	Model		
	Seating	Pillows	Screens
Fabrics			
A: Blanket (4H)	●	●	
A: Hobson (3J)	●	●	
A: Morse (4J)	●	●	
A: Novelty (3L)	●	●	
A: Pixel (2A)		●	
A: Tellure (3A)	●	●	
A: Wellington Faux Leather (XJ)	●		
B: Diagonale (4N)	●	●	
B: Element (4Z)	●	●	
B: English Tweed (4E)		●	
B: Floyd by Kvadrat	●	●	
B: Kaleidoscope (S4)	●	●	
B: Pemberton (SN)	●		
B: Ramie (4V)	●	●	
B: Reflect by Kvadrat (S8)		●	
B: Squares (RA)	●	●	
B: Tech (MV)	●	●	
C: Dots (6K)	●	●	
C: King II (67)	●	●	●
C: Maya II (68)	●	●	●
C: Oceanic (4T)	●	●	
C: Scapes (3S)	●	●	
D: Atlas by Kvadrat (LW)	●	●	
D: Big Arrow (4D)	●	●	
D: Big Diagonale (1K)	●	●	
D: Clara 2 by Kvadrat (NV)	●	●	
D: Class II (66)	●	●	●
D: Cotswold (JB)	●	●	
D: Main Line Flax (6M)	●	●	
D: Melange Nap by Kvadrat (S7)	●	●	
D: Recheck by Kvadrat (RP)	●	●	
E: Brisa Faux Leather (XG)	●		
E: Steelcut Trio by Kvadrat (SY)	●	●	
F: Divina Melange 3 by Kvadrat (SV)	●	●	
F: Hallingdal 65 by Kvadrat (SZ)	●	●	
Leathers			
A: Plains Leather (XP)	●		
B: Nature Leather (XE)	●		

ALERT: These materials are current, however they are being considered for future obsolescence due to low volume.

Grade A

Twist (MM)

Grade B

Gauge (1X)

Grade D

Tangram (LV)

Haworth Alliance

For information on the Haworth Alliance Program, please refer to: surfaces.haworth.com

Customer's Own Material (COM)

For Customer's Own Material (COM) information including requesting a new COM, please refer to: surfaces.haworth.com

* For most current finish and fabric availability please reference surfaces.haworth.com.

Index

Products are listed alphabetically in this index by alpha-numeric prefix/suffix codes.

Product Code	Product Description	Page
EURT-0000-N001CB	Bezel Utility Module25
EURT-0000-N001CW	Bezel Utility Module25
EURT-0000-N001SB	Bezel Utility Module25
EURT-0000-N001SW	Bezel Utility Module25
EURT-0072-1010	Bezel Utility Module25
EURT-0072-1100	Bezel Utility Module25
HOA1-3	Double Booth18
HOAB-2	Single Booth17
HOAC-3	Corner Booth19
HOAD-3	Double Desk15
HOAE-5	Privacy Booth20
HOAP-3	Privacy Desk16
HOAS-2	Single Desk14
HOAW-5	Conference Booth21
HOCH	Accessories – Coat Hook23
HOPD	Hideaway Power Module24
HOUP	Accessories – Pillows23
HOUS	Accessories – Soft Storage23
HOUT-1616	Height Adjustable Table22
SODB-2424-P	Sprig Tables – Round13
SODC-1616-P	Sprig Tables – Round13
SON-3	Plume Screens – Plume 38
SON-6	Plume Screens – Plume 68
SON-9	Plume Screens – Plume 98
SOPB-2223	Chick Pouf – Chick Pouf with Back10
SOPN-2223	Chick Pouf – Chick Pouf without Back10
SOPN-2238	Chick Pouf – Large Square - No Back11
SOPN-2252	Chick Pouf – Rectangle - No Back11
SOPN-2265	Chick Pouf – Round - No Back12
SORA-5320-P	Sprig Tables – Rectangle13
SOSR-1-RW	Feather Sofa – Feather – Asymmetrical9
SOSS-1-RW	Feather Sofa – Feather – Symmetrical9

Product Compatibility and Limited Warranty Policy

Great Expectations

You have them as a Haworth customer and so do we. And because we value our customers, we cover our products with the Haworth North America Product Compatibility and Limited Warranty Policy.

Our Commitment To Product Compatibility – Integrated Product Platforms

As a market leader in the design and manufacture of workspaces that adapt to change, we strive to maintain product compatibility within our various generations of integrated product platforms. This benefits the customer who desires to update or modify their work environment. It also benefits the customer needing to replace a product due to damage or other reasons but which is no longer manufactured or is otherwise unavailable, such as a fabric or finish that is discontinued because of changing market preferences. In both circumstances, we often can provide products with comparable function and performance.

Our Commitment To Product Quality – The Haworth North America Limited Warranty

To ensure customer satisfaction and peace of mind, we stand behind our products with the Haworth North America Limited Warranty. To review the current version of the limited warranty including its terms and conditions, please go to:

www.haworth.com/warranty or contact OneTouch@Haworth.com or 1 877 429 6784.

Warranty Requests or Questions

For questions or service requests pertaining to the Haworth Limited Warranty, please contact your Haworth dealer.

If you are unsure who your dealer is, please contact **OneTouch@Haworth.com or 1 877 429 6784.**

Effective: September 1, 2021

HAWORTH

HAWORTH® is a registered trademark of Haworth, Inc.

© Haworth, Inc. All rights reserved. 2024 8.24

haworth.com | 800 344 2600